

DIAMOND WIRE SPRING COMPANY

Designer and Manufacturer of Precision Springs Since 1939

STOCK SPRING CATALOG

- *Compression, Extension, Die Springs*
- *Thousands in Stock Today*
- *Quick Turnaround on Custom Orders*



1-800-424-0500

Fax: 412-492-0106

catalog@stocksprings.com

www.diamondwire.com



COMBINING EXPERIENCE, ENGINEERING AND TECHNOLOGY

With over 70 years of experience, Diamond Wire Spring Company has the knowledge and capabilities to meet your specifications and exceed your expectations. We are a leading designer and manufacturer of all types of coil springs—compression, extension, torsion, die springs—and wire forms. We take great pride in our ability to meet individual customer demands through uncompromising commitment to quality and fast delivery at competitive prices.

All of our springs are made in our four U.S. manufacturing facilities. We are a worldwide supplier with more than 10,000 different springs available and 1.5 million parts in stock for a same-day shipment schedule so even your tightest deadlines will be met. We also provide customized components for specialty manufacturing needs; where we can manage release schedules on your Kanban or JIT blanket orders. Our onsite engineers will assist you with all aspects of design from the wide variety of raw materials—low carbon, high strength, high temperature alloy steels—through to end production and delivery, whether you are ordering one spring or one million springs. Customer drawings and specifications are reviewed for compliance with all requirements to ensure the spring we manufacture meets your needs.

Another critical element of our success is performance. Because of our engineering experience and dedication to customer service, we are the spring supplier of choice for many demanding industries—power and energy, rail and transportation, actuators and valves, shock and vibration, drilling and mining, agricultural and off road, gas and steam, material handling, snow removal and medical. In both stock and custom orders, exceptional product consistency remains vital to the success of our customers and our success as their supplier.

For a rapid response quote or to place an order, call 1-800-424-0500 or visit our website at www.diamondwire.com.



TABLE OF CONTENTS



CUSTOM SPRINGS

Prompt Quotes - Fast Delivery

Engineering Services	1
Introduction	2
General Specifications	2
Specification Forms (Inquiry)	151
Conditions of Sale	157
Glossary of Spring Terminology	159

STOCK SPRINGS

Prompt Delivery From Stock

Micro Precision Springs	3
Precision Springs	6
Compression Springs	31
Extension Springs	120
Snow Plow Springs	141
Die Springs	142

CATALOG DIVISION GLENSHAW, PA

CALL US TOLL-FREE: 1-800-424-0500
OUTSIDE U.S. AND CANADA: 412-492-8280
FAX: (412) 492-0106
EMAIL: catalog@stocksprings.com

Or Call Our Manufacturing Facility Nearest You

PITTSBURGH, PA (800) 816-5613 FAX (412) 821-2743
TAYLORS, SC (800) 933-7774 FAX (864) 268-6705
TYLER, TX (800) 938-3510 FAX (903) 581-6529

ENGINEERING SERVICE FOR CUSTOM MADE SPRINGS

Diamond has three facilities to manufacture custom springs. Therefore, if you do not find a stock spring to suit your needs, call our nearest plant for design assistance or photo copy, complete and fax the inquiry sheet found in the back of this catalog.

Order Online

Visit our website: www.diamondwire.com

MICRO
SPRINGS

PRECISION
SPRINGS

COMPRESSION
SPRINGS

EXTENSION
SPRINGS

SNOW PLOW
SPRINGS

DIE
SPRINGS

FORMS

INTRODUCTION



The Diamond Wire Spring Catalog offers its users an array of springs which can be used in all types of applications. Compression springs are carried in stock from .003 diameter wire to .625 wire and are wound with a pitch that will stand full deflection to solid height. Outside diameters are made according to different hole sizes and over different rod sizes. These springs are stocked/inventoried and ready for immediate shipment from our warehouse in Glenshaw, PA. When ordering, please ask for the stock spring department.

GENERAL SPECIFICATIONS

Material

All material up to .106 is Music. Wire over .106 is Oil Tempered. Stainless steel springs are available up to .135" wire. When stainless steel is used the value for Rate (R) and Load (P) must be corrected by multiplying by 0.833.

Finish

ALL parts are plain finish. Zinc plate is available for an extra charge.

Direction of Wind

Right Hand

Ends

Compression Springs - Ends squared and ground (Tolerance 3°)

Extension Springs - Full loops with/without opening.

Tolerances

Tolerances are held closely to various sizes according to outside diameter and free length.

Liability

Having no control over the use of the products in this catalog, all implied warranties of any type (including without limitation merchantability or of fitness for a particular purpose) are hereby disclaimed and excluded. In no event shall Diamond Wire Spring Company be liable for incidental or consequential damages or for loss of profits. Remedies are expressly limited to refund or replacement. Furthermore, all sales are subject to Diamond Wire Spring Company's standard Conditions of Sale, including without limitations, all disclaimers and exclusions of warranties, all limitations of damages and the limitation of remedies to refund or replacement.

NOTES

Spring rates, maximum loads and initial tension shown in catalog are for Music Wire and Oil Tempered Wire.

COMPRESSION SPRINGS – To find the load at any working length, when free length and rate are given, use the formula $P = R \times F$. Where P is load in Lbs.; R is the rate in Lbs. per Inch; F is the deflection from free length.

EXAMPLE: (DWC-020A-5) Given a free length of .625 and rate of 16.2 Pounds per inch, find the load at 1/2" working length. $P = 16.2 \times .125 = 2.0$ Lbs.

EXTENSION SPRING (refer to General Information. Page 120)

DIE SPRING (refer to General Information. Page 142)

**STOCK MICRO
PRECISION SPRINGS**
316 Stainless Steel
Ends Squared Not Ground

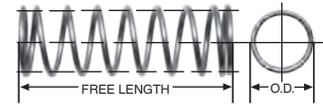

DIAMOND WIRE SPRING STOCK NO.	OUTSIDE DIAMETER	TO WORK IN HOLE DIA.	TO WORK OVER ROD DIA.	WIRE DIAMETER	APPROX. LOAD AT SOLID HT.	FREE LENGTH	SOLID HT.	TOTAL DEFLECTION	SPRING RATE	PRICE GROUP
	IN.	IN.	IN.	IN.	LB.	IN.	IN.	IN.	LB./IN.	
DWM-1	0.025	0.031	0.016	0.003	0.051	0.250	0.095	0.155	0.330	U
DWM-2						0.281	0.107	0.174	0.290	U
DWM-3						0.313	0.117	0.196	0.264	U
DWM-4						0.344	0.129	0.215	0.238	U
DWM-5						0.375	0.141	0.234	0.216	U
DWM-6						0.406	0.150	0.256	0.202	U
DWM-7						0.438	0.162	0.276	0.186	U
DWM-8						0.469	0.174	0.295	0.173	U
DWM-9						0.500	0.183	0.317	0.164	U
DWM-10						0.531	0.195	0.336	0.153	U
DWM-11						0.563	0.207	0.356	0.000	U
DWM-12						0.594	0.216	0.378	0.138	U
DWM-13						0.625	0.228	0.397	0.130	U
DWM-14	0.0375	0.047	0.023	0.003	0.035	0.250	0.051	0.199	0.176	U
DWM-15						0.281	0.057	0.224	0.154	U
DWM-16						0.313	0.063	0.250	0.137	U
DWM-17						0.344	0.069	0.275	0.123	U
DWM-18						0.375	0.072	0.303	0.117	U
DWM-19						0.406	0.078	0.328	0.107	U
DWM-20						0.438	0.084	0.354	0.099	U
DWM-21						0.469	0.090	0.379	0.091	U
DWM-22						0.500	0.096	0.404	0.085	U
DWM-23						0.531	0.099	0.432	0.082	U
DWM-24						0.563	0.105	0.458	0.077	U
DWM-25	0.594	0.111	0.483	0.073	U					
DWM-26	0.625	0.117	0.508	0.068	U					
DWM-27	0.05	0.063	0.039	0.003	0.027	0.250	0.033	0.217	0.122	U
DWM-28						0.281	0.036	0.245	0.108	U
DWM-29						0.313	0.039	0.274	0.098	U
DWM-30						0.344	0.042	0.302	0.089	U
DWM-31						0.375	0.045	0.330	0.081	U
DWM-32						0.406	0.048	0.358	0.075	U
DWM-33						0.438	0.051	0.387	0.070	U
DWM-34						0.469	0.054	0.415	0.065	U
DWM-35						0.500	0.057	0.443	0.061	U
DWM-36						0.531	0.060	0.471	0.057	U
DWM-37						0.563	0.065	0.499	0.053	U
DWM-38						0.594	0.068	0.527	0.050	U
DWM-39	0.625	0.071	0.555	0.048	U					
DWM-40	0.025	0.031	0.008	0.005	0.223	0.250	0.175	0.075	3.052	U
DWM-41						0.281	0.198	0.084	2.676	U
DWM-42						0.313	0.220	0.093	2.382	U
DWM-43						0.344	0.240	0.104	2.170	U
DWM-44						0.375	0.263	0.113	1.973	U
DWM-45						0.406	0.283	0.124	1.825	U
DWM-46						0.438	0.305	0.133	1.684	U
DWM-47						0.469	0.325	0.144	1.575	U
DWM-48	0.500	0.348	0.153	1.469	U					

Please inquire if you need a size not listed above.

**STOCK MICRO
PRECISION SPRINGS**
316 Stainless Steel
Ends Squared Not Ground

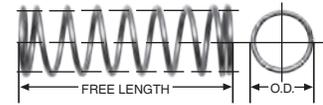

MICRO SPRINGS

DIAMOND WIRE SPRING STOCK NO.	OUTSIDE DIAMETER	TO WORK IN HOLE DIA.	TO WORK OVER ROD DIA.	WIRE DIAMETER	APPROX. LOAD AT SOLID HT.	FREE LENGTH	SOLID HT.	TOTAL DEFLECTION	SPRING RATE	PRICE GROUP
	IN.	IN.	IN.	IN.	LB.	IN.	IN.	IN.	LB./IN.	
DWM-49	0.025	0.031	0.008	0.005	0.223	0.531	0.370	0.161	1.375	U
DWM-50						0.563	0.390	0.173	1.302	U
DWM-51						0.594	0.410	0.184	1.236	U
DWM-52						0.625	0.433	0.193	1.170	U
DWM-53	0.0375	0.047	0.0023	0.005	0.157	0.250	0.115	0.135	1.138	U
DWM-54						0.281	0.128	0.154	1.011	U
DWM-55						0.313	0.140	0.173	0.910	U
DWM-56						0.344	0.153	0.192	0.828	U
DWM-57						0.375	0.165	0.210	0.759	U
DWM-58						0.406	0.178	0.229	0.700	U
DWM-59						0.438	0.193	0.245	0.641	U
DWM-60						0.469	0.205	0.264	0.599	U
DWM-61						0.500	0.218	0.283	0.562	U
DWM-62						0.531	0.230	0.301	0.529	U
DWM-63						0.563	0.245	0.318	0.495	U
DWM-64						0.594	0.255	0.339	0.474	U
DWM-65						0.625	0.270	0.355	0.446	U
DWM-66	0.05	0.063	0.031	0.005	0.122	0.250	0.078	0.173	0.686	U
DWM-67						0.281	0.085	0.196	0.612	U
DWM-68						0.313	0.093	0.221	0.553	U
DWM-69						0.344	0.103	0.242	0.490	U
DWM-70						0.375	0.110	0.265	0.451	U
DWM-71						0.406	0.118	0.289	0.418	U
DWM-72						0.438	0.125	0.313	0.390	U
DWM-73						0.469	0.135	0.334	0.357	U
DWM-74						0.500	0.143	0.358	0.336	U
DWM-75						0.531	0.150	0.381	0.318	U
DWM-76						0.563	0.160	0.403	0.296	U
DWM-77						0.594	0.165	0.429	0.286	U
DWM-78	0.625	0.175	0.450	0.268	U					
DWM-79	0.0375	0.047	0.016	0.007	0.419	0.250	0.168	0.082	5.037	U
DWM-80						0.281	0.189	0.092	4.407	U
DWM-81						0.313	0.210	0.103	3.918	U
DWM-82						0.344	0.228	0.117	3.586	U
DWM-83						0.375	0.249	0.127	3.255	U
DWM-84						0.406	0.266	0.140	3.022	U
DWM-85						0.438	0.287	0.151	2.784	U
DWM-86						0.469	0.308	0.161	2.580	U
DWM-87						0.500	0.329	0.171	2.404	U
DWM-88						0.531	0.347	0.185	2.275	U
DWM-89						0.563	0.368	0.196	2.137	U
DWM-90						0.594	0.389	0.206	2.015	U
DWM-91						0.625	0.406	0.219	1.923	U
DWM-92	0.05	0.063	0.313	0.007	0.318	0.250	0.126	0.124	2.517	U
DWM-93						0.281	0.137	0.145	2.288	U
DWM-94						0.313	0.151	0.163	2.040	U
DWM-95						0.344	0.168	0.176	1.798	U
DWM-96						0.375	0.182	0.193	1.641	U

Please inquire if you need a size not listed above.

**STOCK MICRO
PRECISION SPRINGS**
316 Stainless Steel
Ends Squared Not Ground



WIRE DIAMETER	APPROX. LOAD AT SOLID HT.	FREE LENGTH	SOLID HT.	TOTAL DEFLECTION	SPRING RATE	FREE LENGTH	SOLID HT.	TOTAL DEFLECTION	SPRING RATE	PRICE GROUP
	IN.	IN.	IN.	IN.	LB.	IN.	IN.	IN.	LB./IN.	
DWM-97	0.05	0.063	0.313	0.007	0.318	0.406	0.196	0.210	1.510	U
DWM-98						0.438	0.210	0.228	1.398	U
DWM-99						0.469	0.224	0.245	1.302	U
DWM-100						0.500	0.238	0.262	1.218	U
DWM-101						0.531	0.252	0.279	1.144	U
DWM-102						0.563	0.266	0.297	1.079	U
DWM-103						0.594	0.280	0.314	1.020	U
DWM-104						0.625	0.294	0.331	0.968	U
DWM-105	0.0625	0.078	0.037	0.007	0.250	0.250	0.098	0.152	1.596	U
DWM-106						0.281	0.109	0.173	1.404	U
DWM-107						0.313	0.119	0.194	1.254	U
DWM-108						0.344	0.130	0.215	1.133	U
DWM-109						0.375	0.140	0.235	1.033	U
DWM-110						0.406	0.151	0.256	0.949	U
DWM-111						0.438	0.161	0.277	0.878	U
DWM-112						0.469	0.172	0.298	0.817	U
DWM-113						0.500	0.182	0.318	0.763	U
DWM-114						0.531	0.193	0.339	0.717	U
DWM-115						0.563	0.203	0.360	0.675	U
DWM-116						0.594	0.214	0.381	0.638	U
DWM-117						0.625	0.224	0.401	0.605	U

MICRO
SPRINGS

Please inquire if you need a size not listed above.

STOCK PRECISION SPRINGS

316 Stainless Steel

Ends Squared and Ground
(See Below)

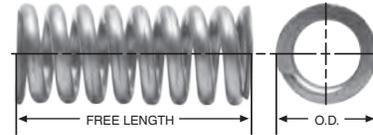

PRECISION SPRINGS

DIAMOND WIRE SPRING STOCK NO.	OUTSIDE DIAMETER	TO WORK IN HOLE DIA.	TO WORK OVER ROD DIA.	WIRE DIAMETER	APPROX. LOAD AT SOLID HT.	FREE LENGTH	SOLID HT.	TOTAL DEFLECTION	SPRING RATE	PRICE GROUP
	IN.	IN.	IN.	IN.	LB.	IN.	IN.	IN.	LB./IN.	
DWP-1	0.047	0.062	0.026	0.008	0.654	0.079	0.051	0.028	23.350	E
DWP-2					0.579	0.106	0.067	0.039	14.840	E
DWP-3					0.609	0.154	0.091	0.063	9.660	E
DWP-4					0.623	0.217	0.122	0.095	6.560	E
DWP-5					0.604	0.307	0.169	0.138	4.380	E
DWP-6	0.055	0.070	0.034	0.008	0.538	0.091	0.051	0.040	13.460	E
DWP-7					0.508	0.126	0.067	0.059	8.610	E
DWP-8					0.497	0.181	0.091	0.090	5.520	E
DWP-9					0.511	0.256	0.122	0.134	3.810	E
DWP-10					0.506	0.366	0.169	0.197	2.570	E
DWP-11	0.057	0.062	0.026	0.006	0.241	0.120	0.044	0.076	3.170	E
DWP-12					0.238	0.190	0.060	0.130	1.830	E
DWP-13					0.233	0.250	0.075	0.175	1.330	E
DWP-14					0.240	0.310	0.088	0.222	1.080	E
DWP-15					0.258	0.380	0.100	0.280	0.920	E
DWP-16					0.242	0.440	0.118	0.322	0.750	E
DWP-17					0.248	0.500	0.130	0.370	0.670	E
DWP-18					0.289	0.560	0.129	0.431	0.670	E
DWP-19					0.277	0.620	0.142	0.478	0.580	E
DWP-20	0.057	0.062	0.026	0.007	0.391	0.120	0.053	0.067	5.830	E
DWP-21					0.386	0.190	0.074	0.116	3.330	E
DWP-22					0.415	0.250	0.089	0.161	2.580	E
DWP-23					0.404	0.310	0.108	0.202	2.000	E
DWP-24					0.395	0.380	0.130	0.250	1.580	E
DWP-25					0.422	0.440	0.143	0.297	1.420	E
DWP-26					0.428	0.500	0.158	0.342	1.250	E
DWP-27					0.411	0.560	0.179	0.381	1.080	E
DWP-28	0.432	0.620	0.188	0.432	1.000	E				
DWP-29	0.057	0.062	0.026	0.008	0.614	0.120	0.061	0.059	10.410	E
DWP-30					0.624	0.190	0.086	0.104	6.000	E
DWP-31					0.635	0.250	0.106	0.144	4.410	E
DWP-32					0.641	0.310	0.127	0.183	3.500	E
DWP-33					0.651	0.380	0.150	0.230	2.830	E
DWP-34					0.649	0.440	0.172	0.268	2.420	E
DWP-35					0.634	0.500	0.195	0.305	2.080	E
DWP-36					0.628	0.560	0.217	0.343	1.830	E
DWP-37					0.661	0.620	0.224	0.396	1.670	E
DWP-38	0.057	0.062	0.026	0.010	0.992	0.094	0.064	0.030	33.060	E
DWP-39					0.967	0.130	0.084	0.046	21.020	E
DWP-40					0.979	0.185	0.113	0.072	13.600	E
DWP-41					0.988	0.260	0.153	0.107	9.230	E
DWP-42					0.992	0.370	0.212	0.158	6.280	E
DWP-43	0.063	0.078	0.044	0.007	0.356	0.125	0.047	0.078	4.560	E
DWP-44					0.355	0.188	0.063	0.125	2.840	E
DWP-45					0.354	0.250	0.079	0.171	2.070	E
DWP-46					0.353	0.313	0.095	0.218	1.620	E
DWP-47					0.355	0.375	0.110	0.265	1.340	E
DWP-48					0.353	0.438	0.126	0.312	1.130	E

Wire size below .031 squared and not ground. Wire size .031 and above, squared with ground ends. Please inquire if you need a size not listed above.

STOCK PRECISION SPRINGS

316 Stainless Steel

Ends Squared and Ground
(See Below)

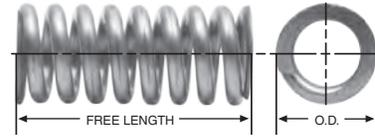

DIAMOND WIRE SPRING STOCK NO.	OUTSIDE DIAMETER	TO WORK IN HOLE DIA.	TO WORK OVER ROD DIA.	WIRE DIAMETER	APPROX. LOAD AT SOLID HT.	FREE LENGTH	SOLID HT.	TOTAL DEFLECTION	SPRING RATE	PRICE GROUP
	IN.	IN.	IN.	IN.	LB.	IN.	IN.	IN.	LB./IN.	
DWP-49	0.063	0.078	0.044	0.007	0.354	0.500	0.142	0.358	0.990	E
DWP-50					0.352	0.563	0.158	0.405	0.870	E
DWP-51					0.353	0.625	0.173	0.452	0.780	E
DWP-52	0.063	0.078	0.042	0.008	0.711	0.125	0.051	0.074	9.610	E
DWP-53					0.716	0.188	0.067	0.121	5.920	E
DWP-54					0.716	0.250	0.083	0.167	4.290	E
DWP-55					0.716	0.313	0.100	0.213	3.360	E
DWP-56					0.715	0.375	0.116	0.259	2.760	E
DWP-57					0.716	0.438	0.132	0.306	2.340	E
DWP-58					0.718	0.500	0.148	0.352	2.040	E
DWP-59					0.716	0.563	0.165	0.398	1.800	E
DWP-60					0.715	0.625	0.181	0.444	1.610	E
DWP-61	0.063	0.078	0.044	0.009	0.778	0.125	0.064	0.061	12.760	E
DWP-62					0.784	0.188	0.087	0.101	7.760	E
DWP-63					0.778	0.250	0.111	0.139	5.600	E
DWP-64					0.782	0.313	0.134	0.179	4.370	E
DWP-65					0.783	0.375	0.157	0.218	3.590	E
DWP-66					0.781	0.438	0.181	0.257	3.040	E
DWP-67					0.781	0.500	0.204	0.296	2.640	E
DWP-68					0.781	0.563	0.228	0.335	2.330	E
DWP-69					0.782	0.625	0.251	0.374	2.090	E
DWP-70	0.063	0.078	0.044	0.010	1.098	0.125	0.071	0.054	20.340	E
DWP-71					1.088	0.188	0.099	0.089	12.230	E
DWP-72					1.089	0.250	0.126	0.124	8.780	E
DWP-73					1.091	0.313	0.153	0.160	6.820	E
DWP-74					1.092	0.375	0.180	0.195	5.600	E
DWP-75					1.093	0.438	0.207	0.231	4.730	E
DWP-76					1.093	0.500	0.234	0.266	4.110	E
DWP-77					1.090	0.563	0.262	0.301	3.620	E
DWP-78	1.089	0.625	0.289	0.336	3.240	E				
DWP-79	0.071	0.086	0.050	0.008	0.383	0.118	0.051	0.067	5.710	E
DWP-80					0.388	0.173	0.067	0.106	3.660	E
DWP-81					0.375	0.252	0.091	0.161	2.330	E
DWP-82					0.389	0.362	0.122	0.240	1.620	E
DWP-83					0.387	0.524	0.169	0.355	1.090	E
DWP-84	0.073	0.088	0.048	0.010	0.753	0.118	0.064	0.054	13.940	E
DWP-85					0.752	0.169	0.084	0.085	8.850	E
DWP-86					0.748	0.244	0.113	0.131	5.710	E
DWP-87					0.751	0.343	0.153	0.190	3.950	E
DWP-88					0.734	0.492	0.212	0.280	2.620	E
DWP-89	0.076	0.091	0.045	0.013	1.496	0.122	0.082	0.040	37.390	E
DWP-90					1.569	0.173	0.107	0.066	23.780	E
DWP-91					1.587	0.248	0.145	0.103	15.410	E
DWP-92					1.548	0.343	0.195	0.148	10.460	E
DWP-93					1.567	0.492	0.271	0.221	7.090	E
DWP-94	0.087	0.102	0.066	0.008	0.307	0.157	0.051	0.106	2.900	E
DWP-95					0.299	0.232	0.067	0.165	1.810	E
DWP-96					0.300	0.343	0.091	0.252	1.190	E

PRECISION SPRINGS

Wire size below .031 squared and not ground. Wire size .031 and above, squared with ground ends. Please inquire if you need a size not listed above.

STOCK PRECISION SPRINGS

316 Stainless Steel

Ends Squared and Ground
(See Below)

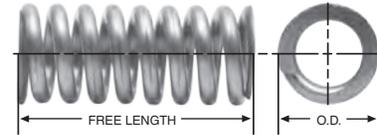

PRECISION SPRINGS

DIAMOND WIRE SPRING STOCK NO.	OUTSIDE DIAMETER	TO WORK IN HOLE DIA.	TO WORK OVER ROD DIA.	WIRE DIAMETER	APPROX. LOAD AT SOLID HT.	FREE LENGTH	SOLID HT.	TOTAL DEFLECTION	SPRING RATE	PRICE GROUP
	IN.	IN.	IN.	IN.	LB.	IN.	IN.	IN.	LB./IN.	
DWP-97	0.087	0.102	0.066	0.008	0.322	0.496	0.122	0.374	0.860	E
DWP-98					0.314	0.720	0.169	0.551	0.570	E
DWP-99	0.088	0.103	0.026	0.008	0.404	0.120	0.043	0.077	5.250	E
DWP-100					0.394	0.190	0.055	0.135	2.920	E
DWP-101					0.404	0.250	0.064	0.186	2.170	E
DWP-102					0.415	0.310	0.073	0.237	1.750	E
DWP-103					0.420	0.380	0.084	0.296	1.420	E
DWP-104					0.435	0.440	0.092	0.348	1.250	E
DWP-105					0.431	0.500	0.101	0.399	1.080	E
DWP-106					0.409	0.560	0.115	0.445	0.920	E
DWP-107					0.416	0.620	0.119	0.501	0.830	E
DWP-108	0.088	0.103	0.066	0.010	0.615	0.120	0.060	0.060	10.250	E
DWP-109					0.617	0.190	0.081	0.109	5.660	E
DWP-110					0.634	0.250	0.098	0.152	4.170	E
DWP-111					0.609	0.310	0.118	0.192	3.170	E
DWP-112					0.688	0.380	0.130	0.250	2.750	E
DWP-113					0.683	0.440	0.147	0.293	2.330	E
DWP-114					0.630	0.500	0.172	0.328	1.920	E
DWP-115					0.656	0.560	0.185	0.375	1.750	E
DWP-116					0.662	0.620	0.201	0.419	1.580	E
DWP-117					0.677	0.690	0.213	0.477	1.420	E
DWP-118	0.694	0.750	0.228	0.522	1.330	E				
DWP-119	0.088	0.103	0.066	0.012	0.922	0.120	0.075	0.045	20.490	E
DWP-120					1.087	0.190	0.100	0.090	12.080	E
DWP-121					1.111	0.250	0.123	0.127	8.750	E
DWP-122					1.079	0.310	0.148	0.162	6.660	E
DWP-123					1.125	0.380	0.172	0.208	5.410	E
DWP-124					1.183	0.440	0.191	0.249	4.750	E
DWP-125					1.163	0.500	0.215	0.285	4.080	E
DWP-126					1.193	0.560	0.235	0.325	3.670	E
DWP-127					1.125	0.620	0.265	0.355	3.170	E
DWP-128					1.238	0.690	0.266	0.424	2.920	E
DWP-129	1.220	0.750	0.293	0.457	2.670	E				
DWP-130	0.091	0.106	0.060	0.013	1.224	0.146	0.082	0.064	19.130	E
DWP-131					1.246	0.209	0.107	0.102	12.220	E
DWP-132					1.245	0.303	0.145	0.158	7.880	E
DWP-133					1.257	0.429	0.195	0.234	5.370	E
DWP-134					1.252	0.614	0.271	0.343	3.650	E
DWP-135	0.094	0.109	0.068	0.010	0.726	0.125	0.052	0.073	9.950	E
DWP-136					0.724	0.188	0.067	0.121	5.980	E
DWP-137					0.725	0.250	0.081	0.169	4.290	E
DWP-138					0.735	0.313	0.095	0.218	3.370	E
DWP-139					0.745	0.375	0.108	0.267	2.790	E
DWP-140					0.754	0.438	0.121	0.317	2.380	E
DWP-141					0.761	0.500	0.134	0.366	2.080	E
DWP-142					0.764	0.563	0.148	0.415	1.840	E
DWP-143					0.759	0.625	0.162	0.463	1.640	E

Wire size below .031 squared and not ground. Wire size .031 and above, squared with ground ends. Please inquire if you need a size not listed above.

STOCK PRECISION SPRINGS

316 Stainless Steel

Ends Squared and Ground
(See Below)

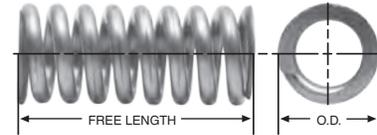

DIAMOND WIRE SPRING STOCK NO.	OUTSIDE DIAMETER	TO WORK IN HOLE DIA.	TO WORK OVER ROD DIA.	WIRE DIAMETER	APPROX. LOAD AT SOLID HT.	FREE LENGTH	SOLID HT.	TOTAL DEFLECTION	SPRING RATE	PRICE GROUP
	IN.	IN.	IN.	IN.	LB.	IN.	IN.	IN.	LB./IN.	
DWP-144	0.094	0.109	0.065	0.012	1.285	0.125	0.064	0.061	21.060	E
DWP-145					1.282	0.188	0.084	0.104	12.330	E
DWP-146	0.094	0.109	0.057	0.016	1.595	0.138	0.102	0.036	44.310	E
DWP-147					1.763	0.197	0.134	0.063	27.980	E
DWP-148					1.730	0.276	0.181	0.095	18.210	E
DWP-149					1.859	0.394	0.244	0.150	12.390	E
DWP-150					1.779	0.551	0.339	0.212	8.390	E
DWP-151					0.102	0.109	0.078	0.010	0.578	0.250
DWP-152	0.591	0.313	0.094	0.219					2.700	E
DWP-153	0.590	0.375	0.107	0.268					2.200	E
DWP-154	0.571	0.438	0.121	0.317					1.800	E
DWP-155	0.584	0.500	0.135	0.365					1.600	E
DWP-156	0.580	0.563	0.149	0.414					1.400	E
DWP-157	0.554	0.625	0.163	0.462					1.200	E
DWP-158	0.560	0.750	0.190	0.560					1.000	E
DWP-159	0.591	0.875	0.218	0.657					0.900	E
DWP-160	0.528	1.000	0.246	0.754					0.700	E
DWP-161	0.102	0.109	0.076	0.011					0.823	0.250
DWP-162					0.819	0.313	0.104	0.209	3.920	E
DWP-163					0.832	0.375	0.119	0.256	3.250	E
DWP-164					0.833	0.438	0.135	0.303	2.750	E
DWP-165					0.816	0.500	0.150	0.350	2.330	E
DWP-166					0.826	0.563	0.166	0.397	2.080	E
DWP-167					0.811	0.625	0.182	0.443	1.830	E
DWP-168					0.806	0.750	0.213	0.537	1.500	E
DWP-169					0.839	0.875	0.244	0.631	1.330	E
DWP-170					0.848	1.000	0.275	0.725	1.170	E
DWP-171	0.102	0.109	0.074	0.012	1.058	0.250	0.101	0.149	7.100	E
DWP-172					1.013	0.313	0.120	0.193	5.250	E
DWP-173					1.015	0.375	0.139	0.236	4.300	E
DWP-174					1.036	0.438	0.158	0.280	3.700	E
DWP-175					1.037	0.500	0.176	0.324	3.200	E
DWP-176					0.994	0.563	0.195	0.368	2.700	E
DWP-177					1.028	0.625	0.214	0.411	2.500	E
DWP-178					1.048	0.750	0.251	0.499	2.100	E
DWP-179					0.996	0.875	0.289	0.586	1.700	E
DWP-180					1.011	1.000	0.326	0.674	1.500	E
DWP-181	0.106	0.121	0.085	0.008	0.240	0.213	0.051	0.162	1.480	E
DWP-182					0.248	0.323	0.067	0.256	0.970	E
DWP-183					0.250	0.488	0.091	0.397	0.630	E
DWP-184					0.233	0.705	0.122	0.583	0.400	E
DWP-185					0.250	1.031	0.169	0.862	0.290	E
DWP-186	0.106	0.110	0.079	0.011	0.753	0.157	0.047	0.110	6.844	E
DWP-187					0.776	0.630	0.189	0.441	1.760	E
DWP-188					0.754	0.787	0.236	0.551	1.369	E
DWP-189					0.779	0.984	0.276	0.708	1.100	E
DWP-190					0.780	1.260	0.374	0.886	0.880	E
DWP-191					0.754	1.575	0.472	1.103	0.684	E

Wire size below .031 squared and not ground. Wire size .031 and above, squared with ground ends. Please inquire if you need a size not listed above.

PRECISION
SPRINGS

STOCK PRECISION SPRINGS

316 Stainless Steel

Ends Squared and Ground
(See Below)

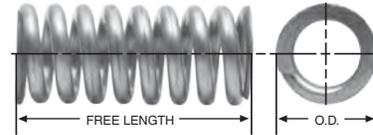

PRECISION SPRINGS

DIAMOND WIRE SPRING STOCK NO.	OUTSIDE DIAMETER	TO WORK IN HOLE DIA.	TO WORK OVER ROD DIA.	WIRE DIAMETER	APPROX. LOAD AT SOLID HT.	FREE LENGTH	SOLID HT.	TOTAL DEFLECTION	SPRING RATE	PRICE GROUP
	IN.	IN.	IN.	IN.	LB.	IN.	IN.	IN.	LB./IN.	
DWP-192	0.106	0.110	0.079	0.011	0.754	1.575	0.472	1.103	0.684	E
DWP-193					0.777	1.969	0.551	1.418	0.548	E
DWP-194					0.779	2.480	0.709	1.771	0.440	E
DWP-195	0.106	0.110	0.071	0.016	2.183	0.197	0.098	0.099	22.050	E
DWP-196					2.223	0.248	0.122	0.126	17.640	E
DWP-197					2.230	0.315	0.157	0.158	14.112	E
DWP-198					2.172	0.394	0.197	0.197	11.025	E
DWP-199					2.187	0.492	0.244	0.248	8.820	E
DWP-200					2.223	0.630	0.315	0.315	7.056	E
DWP-201					2.201	0.787	0.394	0.393	5.600	E
DWP-202					2.170	0.984	0.492	0.492	4.410	E
DWP-203					2.223	1.260	0.630	0.630	3.528	E
DWP-204					2.172	1.969	0.984	0.985	2.205	E
DWP-205	0.106	0.110	0.063	0.020	3.857	0.197	0.126	0.071	54.321	E
DWP-206					3.867	0.248	0.161	0.087	44.444	E
DWP-207					3.841	0.315	0.205	0.110	34.921	E
DWP-208					3.857	0.394	0.252	0.142	27.160	E
DWP-209					3.846	0.492	0.315	0.177	21.728	E
DWP-210					3.859	0.630	0.409	0.221	17.460	E
DWP-211					3.841	0.787	0.512	0.275	13.968	E
DWP-212					3.846	0.984	0.630	0.354	10.864	E
DWP-213					3.850	1.260	0.819	0.441	8.730	E
DWP-214	3.848	1.575	1.024	0.551	6.984	E				
DWP-215	0.108	0.123	0.083	0.010	0.471	0.193	0.064	0.129	3.650	E
DWP-216					0.475	0.287	0.084	0.203	2.340	E
DWP-217					0.468	0.429	0.113	0.316	1.480	E
DWP-218					0.479	0.618	0.153	0.465	1.030	E
DWP-219					0.476	0.902	0.212	0.690	0.690	E
DWP-220	0.111	0.126	0.080	0.013	1.011	0.185	0.082	0.103	9.820	E
DWP-221					1.001	0.268	0.107	0.161	6.220	E
DWP-222					1.008	0.394	0.145	0.249	4.050	E
DWP-223					0.997	0.559	0.195	0.364	2.740	E
DWP-224					0.988	0.811	0.271	0.540	1.830	E
DWP-225	0.114	0.129	0.077	0.016	1.519	0.169	0.102	0.067	22.670	E
DWP-226					1.647	0.248	0.134	0.114	14.450	E
DWP-227					1.648	0.358	0.181	0.177	9.310	E
DWP-228					1.699	0.512	0.244	0.268	6.340	E
DWP-229					1.665	0.728	0.339	0.389	4.280	E
DWP-230	0.118	0.133	0.073	0.020	2.480	0.173	0.128	0.045	55.100	E
DWP-231					2.576	0.240	0.167	0.073	35.290	E
DWP-232					2.672	0.343	0.226	0.117	22.840	E
DWP-233					2.594	0.472	0.305	0.167	15.530	E
DWP-234					2.796	0.689	0.423	0.266	10.510	E
DWP-235	0.120	0.135	0.095	0.010	0.497	0.250	0.064	0.186	2.670	E
DWP-236					0.493	0.310	0.073	0.237	2.080	E
DWP-237					0.496	0.380	0.083	0.297	1.670	E
DWP-238					0.494	0.440	0.092	0.348	1.420	E
DWP-239					0.499	0.500	0.101	0.399	1.250	E

Wire size below .031 squared and not ground. Wire size .031 and above, squared with ground ends. Please inquire if you need a size not listed above.

STOCK PRECISION SPRINGS

316 Stainless Steel

Ends Squared and Ground
(See Below)

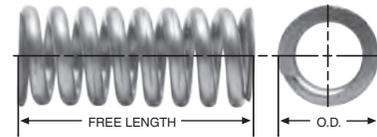

DIAMOND WIRE SPRING STOCK NO.	OUTSIDE DIAMETER	TO WORK IN HOLE DIA.	TO WORK OVER ROD DIA.	WIRE DIAMETER	APPROX. LOAD AT SOLID HT.	FREE LENGTH	SOLID HT.	TOTAL DEFLECTION	SPRING RATE	PRICE GROUP				
	IN.	IN.	IN.	IN.	LB.	IN.	IN.	IN.	LB./IN.					
DWP-240	0.120	0.135	0.095	0.010	0.528	0.560	0.109	0.451	1.170	E				
DWP-241					0.502	0.620	0.118	0.502	1.000	E				
DWP-242					0.516	0.690	0.129	0.561	0.920	E				
DWP-243					0.509	0.750	0.137	0.613	0.830	E				
DWP-244					0.498	0.810	0.146	0.664	0.750	E				
DWP-245					0.543	0.880	0.156	0.724	0.750	E				
DWP-246					0.519	0.940	0.165	0.775	0.670	E				
DWP-247					0.479	1.000	0.174	0.826	0.580	E				
DWP-248					0.538	1.120	0.192	0.928	0.580	E				
DWP-249					0.520	1.250	0.211	1.039	0.500	E				
DWP-250					0.526	1.500	0.248	1.252	0.420	E				
DWP-251	0.120	0.135	0.091	0.012	0.877	0.250	0.083	0.167	5.250	E				
DWP-252					0.897	0.310	0.095	0.215	4.170	E				
DWP-253					0.899	0.380	0.110	0.270	3.330	E				
DWP-254					0.897	0.440	0.123	0.317	2.830	E				
DWP-255					0.913	0.500	0.135	0.365	2.500	E				
DWP-256					0.890	0.560	0.150	0.410	2.170	E				
DWP-257					0.922	0.620	0.159	0.461	2.000	E				
DWP-258					0.898	0.690	0.177	0.513	1.750	E				
DWP-259					0.940	0.750	0.187	0.563	1.670	E				
DWP-260					For additional size options see page 31				0.914	0.810	0.201	0.609	1.500	E
DWP-261					0.951	0.880	0.210	0.670	1.420	E				
DWP-262					0.883	0.940	0.234	0.706	1.250	E				
DWP-263					0.958	1.000	0.234	0.766	1.250	E				
DWP-264					0.923	1.120	0.265	0.855	1.080	E				
DWP-265					0.967	1.250	0.283	0.967	1.000	E				
DWP-266					0.969	1.500	0.333	1.167	0.830	E				
DWP-267	0.136	0.151	0.111	0.010	0.369	0.280	0.064	0.216	1.710	E				
DWP-268					0.384	0.421	0.084	0.337	1.140	E				
DWP-269					0.396	0.634	0.113	0.521	0.760	E				
DWP-270					0.397	0.917	0.153	0.764	0.520	E				
DWP-271					0.373	1.343	0.212	1.131	0.330	E				
DWP-272	0.139	0.154	0.108	0.013	0.765	0.248	0.082	0.166	4.610	E				
DWP-273					0.776	0.370	0.107	0.263	2.950	E				
DWP-274					0.771	0.551	0.145	0.406	1.900	E				
DWP-275					0.793	0.791	0.195	0.596	1.330	E				
DWP-276					0.795	1.154	0.271	0.883	0.900	E				
DWP-277	0.142	0.157	0.105	0.016	1.279	0.220	0.102	0.118	10.840	E				
DWP-278					1.332	0.327	0.134	0.193	6.900	E				
DWP-279					1.301	0.472	0.181	0.291	4.470	E				
DWP-280					1.353	0.689	0.244	0.445	3.040	E				
DWP-281					1.363	1.004	0.339	0.665	2.050	E				
DWP-282	0.146	0.161	0.101	0.020	2.358	0.217	0.128	0.089	26.490	E				
DWP-283					2.418	0.311	0.167	0.144	16.790	E				
DWP-284					2.461	0.453	0.226	0.227	10.840	E				
DWP-285					2.412	0.630	0.305	0.325	7.420	E				
DWP-286					2.505	0.925	0.423	0.502	4.990	E				

PRECISION SPRINGS

Wire size below .031 squared and not ground. Wire size .031 and above, squared with ground ends. Please inquire if you need a size not listed above.

STOCK PRECISION SPRINGS

316 Stainless Steel

Ends Squared and Ground
(See Below)

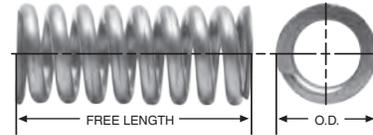

PRECISION SPRINGS

DIAMOND WIRE SPRING STOCK NO.	OUTSIDE DIAMETER	TO WORK IN HOLE DIA.	TO WORK OVER ROD DIA.	WIRE DIAMETER	APPROX. LOAD AT SOLID HT.	FREE LENGTH	SOLID HT.	TOTAL DEFLECTION	SPRING RATE	PRICE GROUP
	IN.	IN.	IN.	IN.	LB.	IN.	IN.	IN.	LB./IN.	
DWP-287	0.151	0.166	0.096	0.025	3.735	0.217	0.161	0.056	66.690	E
DWP-288					4.064	0.307	0.211	0.096	42.330	E
DWP-289					4.061	0.433	0.285	0.148	27.440	E
DWP-290					4.205	0.610	0.385	0.225	18.690	E
DWP-291					4.448	0.886	0.533	0.353	12.600	E
DWP-292	0.156	0.172	0.126	0.010	0.362	0.250	0.052	0.198	1.830	E
DWP-293					0.362	0.313	0.058	0.255	1.420	E
DWP-294					0.360	0.375	0.065	0.310	1.160	E
DWP-295					0.360	0.438	0.071	0.367	0.980	E
DWP-296					0.360	0.500	0.077	0.423	0.850	E
DWP-297					0.359	0.563	0.084	0.479	0.750	E
DWP-298					0.358	0.625	0.090	0.535	0.670	E
DWP-299					0.363	0.750	0.102	0.648	0.560	E
DWP-300					0.357	0.875	0.115	0.760	0.470	E
DWP-301					0.358	1.000	0.128	0.872	0.410	E
DWP-302	0.156	0.171	0.125	0.011	0.489	0.250	0.059	0.191	2.560	E
DWP-303					0.489	0.313	0.066	0.247	1.980	E
DWP-304					0.488	0.375	0.074	0.301	1.620	E
DWP-305					0.489	0.438	0.081	0.357	1.370	E
DWP-306					0.490	0.500	0.088	0.412	1.190	E
DWP-307					0.490	0.563	0.096	0.467	1.050	E
DWP-308					0.491	0.625	0.103	0.522	0.940	E
DWP-309					0.486	0.750	0.119	0.631	0.770	E
DWP-310					0.490	0.875	0.133	0.742	0.660	E
DWP-311					0.485	1.000	0.149	0.851	0.570	E
DWP-312	0.156	0.172	0.126	0.012	0.637	0.250	0.066	0.184	3.460	E
DWP-313					0.635	0.313	0.075	0.238	2.670	E
DWP-314					0.634	0.375	0.084	0.291	2.180	E
DWP-315					0.635	0.438	0.093	0.345	1.840	E
DWP-316					0.633	0.500	0.102	0.398	1.590	E
DWP-317					0.634	0.563	0.110	0.453	1.400	E
DWP-318					0.633	0.625	0.119	0.506	1.250	E
DWP-319					0.631	0.750	0.137	0.613	1.030	E
DWP-320					0.634	0.875	0.154	0.721	0.880	E
DWP-321					0.629	1.000	0.173	0.827	0.760	E
DWP-322	0.156	0.172	0.126	0.013	0.804	0.250	0.074	0.176	4.570	E
DWP-323					0.806	0.375	0.094	0.281	2.870	E
DWP-324					0.805	0.500	0.115	0.385	2.090	E
DWP-325					0.802	0.625	0.136	0.489	1.640	E
DWP-326					0.801	0.750	0.157	0.593	1.350	E
DWP-327					0.802	1.000	0.198	0.802	1.000	E
DWP-328	0.170	0.185	0.139	0.013	0.621	0.343	0.082	0.261	2.380	E
DWP-329					0.601	0.516	0.107	0.409	1.470	E
DWP-330					0.667	0.780	0.145	0.635	1.050	E
DWP-331					0.624	1.126	0.195	0.931	0.670	E
DWP-332					0.662	1.650	0.271	1.379	0.480	E
DWP-333					0.173	0.188	0.136	0.016	1.075	0.295
DWP-334	1.052	0.433	0.134	0.299					3.520	E

Wire size below .031 squared and not ground. Wire size .031 and above, squared with ground ends. Please inquire if you need a size not listed above.

STOCK PRECISION SPRINGS

316 Stainless Steel

Ends Squared and Ground
(See Below)

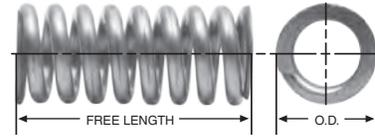

DIAMOND WIRE SPRING STOCK NO.	OUTSIDE DIAMETER	TO WORK IN HOLE DIA.	TO WORK OVER ROD DIA.	WIRE DIAMETER	APPROX. LOAD AT SOLID HT.	FREE LENGTH	SOLID HT.	TOTAL DEFLECTION	SPRING RATE	PRICE GROUP				
	IN.	IN.	IN.	IN.	LB.	IN.	IN.	IN.	LB./IN.					
DWP-335	0.173	0.188	0.136	0.016	1.069	0.650	0.181	0.469	2.280	E				
DWP-336					1.066	0.945	0.244	0.701	1.520	E				
DWP-337					1.112	1.398	0.339	1.059	1.050	E				
DWP-338	0.177	0.192	0.132	0.020	1.992	0.276	0.128	0.148	13.460	E				
DWP-339					1.954	0.394	0.167	0.227	8.610	E				
DWP-340					2.033	0.591	0.226	0.365	5.570	E				
DWP-341					2.034	0.846	0.305	0.541	3.760	E				
DWP-342					2.048	1.220	0.423	0.797	2.570	E				
DWP-343	0.180	0.195	0.151	0.012	0.576	0.250	0.058	0.192	3.000	E				
DWP-344					0.598	0.310	0.063	0.247	2.420	E				
DWP-345					0.595	0.380	0.070	0.310	1.920	E				
DWP-346					0.610	0.440	0.075	0.365	1.670	E				
DWP-347					0.594	0.500	0.082	0.418	1.420	E				
DWP-348					0.590	0.560	0.088	0.472	1.250	E				
DWP-349					0.618	0.620	0.092	0.528	1.170	E				
DWP-350					0.588	0.690	0.102	0.588	1.000	E				
DWP-351					For additional size options see page 36				0.592	0.750	0.107	0.643	0.920	E
DWP-352					0.577	0.810	0.115	0.695	0.830	E				
DWP-353					0.635	0.880	0.115	0.765	0.830	E				
DWP-354					0.613	0.940	0.123	0.817	0.750	E				
DWP-355					0.580	1.000	0.134	0.866	0.670	E				
DWP-356					0.639	1.250	0.149	1.101	0.580	E				
DWP-357					0.667	1.500	0.167	1.333	0.500	E				
DWP-358	0.182	0.197	0.127	0.025	3.508	0.264	0.161	0.103	34.060	E				
DWP-359					3.614	0.378	0.211	0.167	21.640	E				
DWP-360					3.719	0.551	0.285	0.266	13.980	E				
DWP-361					3.823	0.787	0.385	0.402	9.510	E				
DWP-362	3.910	1.142	0.533	0.609	6.420	E								
DWP-363	0.188	0.203	0.156	0.012	0.305	1.375	0.247	1.128	0.270	E				
DWP-364					0.303	1.750	0.308	1.442	0.210	E				
DWP-365	0.188	0.203	0.151	0.013	0.770	0.250	0.060	0.190	4.050	E				
DWP-366					0.768	0.313	0.067	0.246	3.120	E				
DWP-367					0.767	0.375	0.073	0.302	2.540	E				
DWP-368					0.768	0.438	0.079	0.359	2.140	E				
DWP-369					0.766	0.500	0.086	0.414	1.850	E				
DWP-370					0.768	0.563	0.092	0.471	1.630	E				
DWP-371					0.769	0.625	0.098	0.527	1.460	E				
DWP-372					0.767	0.750	0.111	0.639	1.200	E				
DWP-373					0.766	0.875	0.124	0.751	1.020	E				
DWP-374					0.769	1.000	0.136	0.864	0.890	E				
DWP-375					0.761	1.250	0.163	1.087	0.700	E				
DWP-376					0.769	1.375	0.174	1.201	0.640	E				
DWP-377	0.189	0.204	0.122	0.031	9.431	0.272	0.165	0.107	88.140	G				
DWP-378					8.977	0.382	0.223	0.159	56.460	G				
DWP-379					8.755	0.551	0.311	0.240	36.480	G				
DWP-380					8.467	0.768	0.427	0.341	24.830	G				
DWP-381					8.337	1.102	0.604	0.498	16.740	G				

PRECISION SPRINGS

Wire size below .031 squared and not ground. Wire size .031 and above, squared with ground ends. Please inquire if you need a size not listed above.

STOCK PRECISION SPRINGS

316 Stainless Steel

Ends Squared and Ground
(See Below)

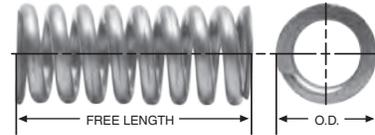

PRECISION SPRINGS

DIAMOND WIRE SPRING STOCK NO.	OUTSIDE DIAMETER	TO WORK IN HOLE DIA.	TO WORK OVER ROD DIA.	WIRE DIAMETER	APPROX. LOAD AT SOLID HT.	FREE LENGTH	SOLID HT.	TOTAL DEFLECTION	SPRING RATE	PRICE GROUP
	IN.	IN.	IN.	IN.	LB.	IN.	IN.	IN.	LB./IN.	
DWP-382	0.213	0.228	0.176	0.016	0.886	0.413	0.102	0.311	2.850	E
DWP-383					0.898	0.630	0.134	0.496	1.810	E
DWP-384					0.909	0.945	0.181	0.764	1.190	E
DWP-385					0.919	1.378	0.244	1.134	0.810	E
DWP-386					0.909	2.087	0.339	1.748	0.520	E
DWP-387	0.217	0.232	0.172	0.020	1.679	0.370	0.128	0.242	6.940	E
DWP-388					1.697	0.551	0.167	0.384	4.420	E
DWP-389					1.685	0.807	0.226	0.581	2.900	E
DWP-390					1.708	1.181	0.305	0.876	1.950	E
DWP-391					1.701	1.752	0.423	1.329	1.280	E
DWP-392	0.218	0.234	0.156	0.008	0.053	0.313	0.046	0.267	0.200	E
DWP-393					0.053	0.500	0.060	0.440	0.120	E
DWP-394					0.050	0.625	0.070	0.555	0.090	E
DWP-395					0.054	0.750	0.079	0.671	0.080	E
DWP-396					0.054	1.000	0.098	0.902	0.060	E
DWP-397					0.045	1.250	0.117	1.133	0.040	E
DWP-398	0.218	0.234	0.156	0.010	0.105	0.313	0.062	0.251	0.420	E
DWP-399					0.104	0.500	0.084	0.416	0.250	E
DWP-400					0.105	0.625	0.098	0.527	0.200	E
DWP-401					0.102	0.750	0.112	0.638	0.160	E
DWP-402					0.103	1.000	0.141	0.859	0.120	E
DWP-403					0.108	1.250	0.170	1.080	0.100	E
DWP-404	0.218	0.234	0.156	0.011	0.159	0.313	0.068	0.245	0.650	E
DWP-405					0.160	0.500	0.091	0.409	0.390	E
DWP-406					0.161	0.625	0.106	0.519	0.310	E
DWP-407					0.157	0.750	0.121	0.629	0.250	E
DWP-408					0.161	1.000	0.152	0.848	0.190	E
DWP-409					0.160	1.250	0.183	1.067	0.150	E
DWP-410	0.218	0.234	0.156	0.012	0.214	0.313	0.075	0.238	0.900	E
DWP-411					0.215	0.500	0.102	0.398	0.540	E
DWP-412					0.212	0.625	0.120	0.505	0.420	E
DWP-413					0.215	0.750	0.137	0.613	0.350	E
DWP-414					0.215	1.000	0.173	0.827	0.260	E
DWP-415					0.208	1.250	0.208	1.042	0.200	E
DWP-416	0.218	0.234	0.156	0.013	0.215	0.313	0.094	0.219	0.980	E
DWP-417					0.214	0.500	0.131	0.369	0.580	E
DWP-418					0.211	0.625	0.156	0.469	0.450	E
DWP-419					0.211	0.750	0.181	0.569	0.370	E
DWP-420					0.215	1.000	0.232	0.768	0.280	E
DWP-421					0.213	1.250	0.282	0.968	0.220	E
DWP-422	0.222	0.237	0.167	0.025	3.054	0.335	0.161	0.174	17.550	F
DWP-423					3.142	0.492	0.211	0.281	11.180	F
DWP-424					3.265	0.728	0.285	0.443	7.370	F
DWP-425					3.131	1.024	0.385	0.639	4.900	G
DWP-426					3.273	1.516	0.533	0.983	3.330	G
DWP-427	0.228	0.243	0.161	0.031	7.343	0.327	0.165	0.162	45.330	F
DWP-428					7.160	0.472	0.224	0.248	28.870	F

Wire size below .031 squared and not ground. Wire size .031 and above, squared with ground ends. Please inquire if you need a size not listed above.

STOCK PRECISION SPRINGS

316 Stainless Steel

Ends Squared and Ground
(See Below)

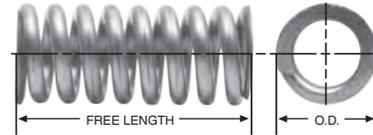

DIAMOND WIRE SPRING STOCK NO.	OUTSIDE DIAMETER	TO WORK IN HOLE DIA.	TO WORK OVER ROD DIA.	WIRE DIAMETER	APPROX. LOAD AT SOLID HT.	FREE LENGTH	SOLID HT.	TOTAL DEFLECTION	SPRING RATE	PRICE GROUP
	IN.	IN.	IN.	IN.	LB.	IN.	IN.	IN.	LB./IN.	
DWP-429	0.228	0.243	0.161	0.031	7.012	0.689	0.313	0.376	18.650	F
DWP-430					6.782	0.965	0.431	0.534	12.700	F
DWP-431					6.916	1.417	0.609	0.808	8.560	G
DWP-432	0.236	0.251	0.153	0.039	13.707	0.335	0.211	0.124	110.540	F
DWP-433					13.031	0.472	0.287	0.185	70.440	F
DWP-434					12.154	0.669	0.402	0.267	45.520	F
DWP-435					12.105	0.945	0.554	0.391	30.960	F
DWP-436					12.035	1.358	0.783	0.575	20.930	G
DWP-437					0.240	0.250	0.188	0.010	0.061	0.313
DWP-438	0.060	0.500	0.097	0.403					0.150	F
DWP-439	0.061	0.625	0.115	0.510					0.120	F
DWP-440	0.056	0.750	0.133	0.617					0.090	F
DWP-441	0.058	1.000	0.169	0.831					0.070	G
DWP-442	0.052	1.250	0.205	1.045					0.050	F
DWP-443	0.240	0.250	0.188	0.011					0.121	0.313
DWP-444					0.119	0.500	0.089	0.411	0.290	F
DWP-445					0.120	0.625	0.104	0.521	0.230	F
DWP-446					0.120	0.750	0.119	0.631	0.190	F
DWP-447					0.119	1.000	0.149	0.851	0.140	G
DWP-448					0.118	1.250	0.179	1.071	0.110	G
DWP-449					0.240	0.250	0.188	0.012	0.182	0.313
DWP-450	0.183	0.500	0.094	0.406					0.450	F
DWP-451	0.181	0.625	0.109	0.516					0.350	F
DWP-452	0.181	0.750	0.125	0.625					0.290	F
DWP-453	0.177	1.000	0.156	0.844					0.210	G
DWP-454	0.181	1.250	0.187	1.063					0.170	G
DWP-455	0.240	0.250	0.188	0.013					0.245	0.313
DWP-456					0.242	0.500	0.103	0.397	0.610	F
DWP-457					0.242	0.625	0.121	0.504	0.480	F
DWP-458					0.245	0.750	0.138	0.612	0.400	F
DWP-459					0.240	1.000	0.173	0.827	0.290	G
DWP-460					0.240	1.250	0.208	1.042	0.230	G
DWP-461					0.240	0.250	0.188	0.014	0.245	0.313
DWP-462	0.244	0.500	0.130	0.370					0.660	F
DWP-463	0.245	0.625	0.154	0.471					0.520	F
DWP-464	0.240	0.750	0.178	0.572					0.420	F
DWP-465	0.240	1.000	0.226	0.774					0.310	G
DWP-466	0.244	1.250	0.274	0.976					0.250	G
DWP-467	0.240	0.255	0.203	0.016					0.924	0.250
DWP-468					0.932	0.310	0.077	0.233	4.000	F
DWP-469					0.962	0.380	0.084	0.296	3.250	F
DWP-470					0.963	0.440	0.090	0.350	2.750	F
DWP-471					0.978	0.500	0.096	0.404	2.420	F
DWP-472					0.948	0.560	0.104	0.456	2.080	F
DWP-473					0.981	0.620	0.109	0.511	1.920	F
DWP-474					0.955	0.690	0.118	0.572	1.670	F
DWP-475					0.992	0.750	0.122	0.628	1.580	F

PRECISION
SPRINGS

Wire size below .031 squared and not ground. Wire size .031 and above, squared with ground ends. Please inquire if you need a size not listed above.

STOCK PRECISION SPRINGS

316 Stainless Steel

Ends Squared and Ground
(See Below)

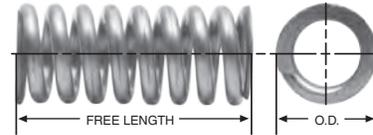

PRECISION SPRINGS

DIAMOND WIRE SPRING STOCK NO.	OUTSIDE DIAMETER	TO WORK IN HOLE DIA.	TO WORK OVER ROD DIA.	WIRE DIAMETER	APPROX. LOAD AT SOLID HT.	FREE LENGTH	SOLID HT.	TOTAL DEFLECTION	SPRING RATE	PRICE GROUP				
	IN.	IN.	IN.	IN.	LB.	IN.	IN.	IN.	LB./IN.					
DWP-476	0.240	0.255	0.203	0.016	0.966	0.810	0.130	0.680	1.420	F				
DWP-477					0.990	0.880	0.136	0.744	1.330	F				
DWP-478					0.997	1.000	0.148	0.852	1.170	G				
DWP-479					0.989	1.250	0.175	1.075	0.920	G				
DWP-480					0.973	1.500	0.203	1.297	0.750	G				
DWP-481					For additional size options see page 45				1.024	1.750	0.222	1.528	0.670	G
DWP-482					1.016	2.000	0.249	1.751	0.580	G				
DWP-483	0.240	0.255	0.199	0.018	1.337	0.250	0.081	0.169	7.910	F				
DWP-484					1.361	0.310	0.089	0.221	6.160	F				
DWP-485					1.385	0.380	0.098	0.282	4.910	F				
DWP-486					1.393	0.440	0.106	0.334	4.170	F				
DWP-487					1.420	0.500	0.113	0.387	3.670	F				
DWP-488					1.430	0.560	0.120	0.440	3.250	F				
DWP-489					1.437	0.620	0.128	0.492	2.920	F				
DWP-490					1.424	0.690	0.138	0.552	2.580	F				
DWP-491					1.405	0.750	0.147	0.603	2.330	F				
DWP-492					For additional size options see page 45				1.426	0.810	0.153	0.657	2.170	F
DWP-493					1.436	0.880	0.162	0.718	2.000	F				
DWP-494					1.440	1.000	0.177	0.823	1.750	G				
DWP-495					1.482	1.250	0.206	1.044	1.420	G				
DWP-496					1.475	1.500	0.239	1.261	1.170	G				
DWP-497					1.480	1.750	0.270	1.480	1.000	G				
DWP-498	1.399	2.000	0.314	1.686	0.830	G								
DWP-499	0.268	0.283	0.223	0.020	1.398	0.531	0.128	0.403	3.470	F				
DWP-500					1.358	0.787	0.167	0.620	2.190	F				
DWP-501					1.366	1.181	0.226	0.955	1.430	G				
DWP-502					1.427	1.732	0.305	1.427	1.000	G				
DWP-503					1.431	2.559	0.423	2.136	0.670	G				
DWP-504	0.273	0.288	0.218	0.025	2.540	0.453	0.161	0.292	8.700	F				
DWP-505					2.551	0.669	0.211	0.458	5.570	F				
DWP-506					2.596	1.004	0.285	0.719	3.610	G				
DWP-507					2.556	1.437	0.385	1.052	2.430	G				
DWP-508					2.581	2.126	0.533	1.593	1.620	G				
DWP-509	0.280	0.295	0.213	0.031	5.650	0.413	0.164	0.249	22.690	H				
DWP-510					5.577	0.610	0.223	0.387	14.410	H				
DWP-511					5.545	0.906	0.311	0.595	9.320	H				
DWP-512					5.513	1.299	0.428	0.871	6.330	I				
DWP-513					5.504	1.890	0.604	1.286	4.280	I				
DWP-514	0.287	0.302	0.204	0.039	10.015	0.394	0.212	0.182	55.030	H				
DWP-515					9.947	0.571	0.288	0.283	35.150	H				
DWP-516					10.092	0.846	0.403	0.443	22.780	H				
DWP-517					10.019	1.201	0.555	0.646	15.510	I				
DWP-518					9.707	1.713	0.785	0.928	10.460	I				
DWP-519	0.297	0.312	0.194	0.049	28.444	0.472	0.266	0.206	138.080	H				
DWP-520					25.829	0.669	0.368	0.301	85.810	H				
DWP-521					26.423	0.984	0.512	0.472	55.980	H				
DWP-522					26.859	1.398	0.700	0.698	38.480	I				
DWP-523					26.332	2.028	1.001	1.027	25.640	I				

Wire size below .031 squared and not ground. Wire size .031 and above, squared with ground ends. Please inquire if you need a size not listed above.

STOCK PRECISION SPRINGS

316 Stainless Steel

Ends Squared and Ground
(See Below)

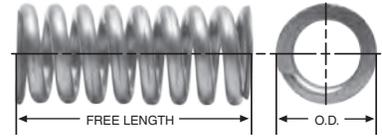

DIAMOND WIRE SPRING STOCK NO.	OUTSIDE DIAMETER	TO WORK IN HOLE DIA.	TO WORK OVER ROD DIA.	WIRE DIAMETER	APPROX. LOAD AT SOLID HT.	FREE LENGTH	SOLID HT.	TOTAL DEFLECTION	SPRING RATE	PRICE GROUP
	IN.	IN.	IN.	IN.	LB.	IN.	IN.	IN.	LB./IN.	
DWP-524	0.300	0.313	0.250	0.011	0.095	0.313	0.055	0.258	0.370	F
DWP-525					0.095	0.500	0.070	0.430	0.220	F
DWP-526					0.093	0.625	0.080	0.545	0.170	F
DWP-527					0.092	0.750	0.090	0.660	0.140	F
DWP-528					0.089	1.000	0.110	0.890	0.100	G
DWP-529					0.090	1.250	0.130	1.120	0.080	G
DWP-530	0.300	0.313	0.250	0.012	0.192	0.313	0.054	0.259	0.740	F
DWP-531					0.191	0.500	0.065	0.435	0.440	F
DWP-532					0.188	0.625	0.073	0.552	0.340	F
DWP-533					0.187	0.750	0.081	0.669	0.280	F
DWP-534					0.190	1.000	0.097	0.903	0.210	G
DWP-535					0.182	1.250	0.113	1.137	0.160	G
DWP-536	0.300	0.313	0.250	0.013	0.288	0.313	0.056	0.257	1.120	F
DWP-537					0.285	0.500	0.068	0.432	0.660	F
DWP-538					0.285	0.625	0.076	0.549	0.520	F
DWP-539					0.286	0.750	0.084	0.666	0.430	F
DWP-540					0.288	1.000	0.100	0.900	0.320	G
DWP-541					0.284	1.250	0.116	1.134	0.250	G
DWP-542	0.300	0.313	0.250	0.014	0.383	0.313	0.061	0.252	1.520	F
DWP-543					0.383	0.500	0.074	0.426	0.900	F
DWP-544					0.379	0.625	0.083	0.542	0.700	F
DWP-545					0.382	0.750	0.091	0.659	0.580	F
DWP-546					0.383	1.000	0.109	0.891	0.430	G
DWP-547					0.382	1.250	0.126	1.124	0.340	G
DWP-548	0.300	0.313	0.250	0.016	0.383	0.313	0.082	0.231	1.660	F
DWP-549					0.381	0.500	0.107	0.393	0.970	F
DWP-550					0.382	0.625	0.123	0.502	0.760	F
DWP-551					0.385	0.750	0.139	0.611	0.630	F
DWP-552					0.381	1.000	0.171	0.829	0.460	G
DWP-553					0.377	1.250	0.204	1.046	0.360	G
DWP-554	0.312	0.328	0.250	0.013	0.103	0.313	0.078	0.235	0.440	F
DWP-555					0.103	0.500	0.104	0.396	0.260	F
DWP-556					0.106	0.625	0.122	0.503	0.210	F
DWP-557					0.104	0.750	0.139	0.611	0.170	F
DWP-558					0.099	1.000	0.175	0.825	0.120	G
DWP-559					0.104	1.250	0.210	1.040	0.100	G
DWP-560	0.312	0.328	0.250	0.014	0.211	0.313	0.071	0.242	0.870	G
DWP-561					0.209	0.500	0.091	0.409	0.510	G
DWP-562					0.208	0.625	0.105	0.520	0.400	G
DWP-563					0.209	0.750	0.118	0.632	0.330	G
DWP-564					0.205	1.000	0.145	0.855	0.240	H
DWP-565					0.205	1.250	0.172	1.078	0.190	H
DWP-566	0.312	0.328	0.250	0.016	0.316	0.313	0.084	0.229	1.380	G
DWP-567					0.316	0.500	0.110	0.390	0.810	G
DWP-568					0.314	0.625	0.127	0.498	0.630	G
DWP-569					0.315	0.750	0.145	0.605	0.520	G

For additional size options see page 50

PRECISION SPRINGS

Wire size below .031 squared and not ground. Wire size .031 and above, squared with ground ends. Please inquire if you need a size not listed above.

STOCK PRECISION SPRINGS

316 Stainless Steel

Ends Squared and Ground
(See Below)

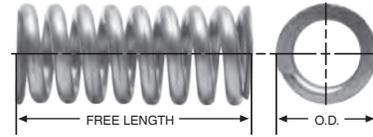

PRECISION SPRINGS

DIAMOND WIRE SPRING STOCK NO.	OUTSIDE DIAMETER	TO WORK IN HOLE DIA.	TO WORK OVER ROD DIA.	WIRE DIAMETER	APPROX. LOAD AT SOLID HT.	FREE LENGTH	SOLID HT.	TOTAL DEFLECTION	SPRING RATE	PRICE GROUP
	IN.	IN.	IN.	IN.	LB.	IN.	IN.	IN.	LB./IN.	
DWP-570	0.312	0.328	0.250	0.016	0.312	1.000	0.179	0.821	0.380	H
DWP-571					0.311	1.250	0.213	1.037	0.300	H
DWP-572	0.312	0.328	0.250	0.018	0.422	0.313	0.101	0.212	1.990	G
DWP-573					0.421	0.500	0.134	0.366	1.150	G
DWP-574					0.421	0.625	0.157	0.468	0.900	G
DWP-575					0.422	0.750	0.180	0.570	0.740	G
DWP-576					0.419	1.000	0.225	0.775	0.540	H
DWP-577					0.421	1.250	0.270	0.980	0.430	H
DWP-578					0.312	0.328	0.250	0.020	0.528	0.313
DWP-579	0.526	0.500	0.163	0.337					1.560	G
DWP-580	0.524	0.625	0.192	0.433					1.210	G
DWP-581	0.524	0.750	0.221	0.529					0.990	G
DWP-582	0.526	1.000	0.279	0.721					0.730	H
DWP-583	0.520	1.250	0.338	0.912					0.570	H
DWP-584	0.340	0.355	0.285	0.025	1.984	0.630	0.161	0.469	4.230	G
DWP-585					2.043	0.965	0.211	0.754	2.710	G
DWP-586					2.063	1.457	0.285	1.172	1.760	H
DWP-587					2.118	2.165	0.385	1.780	1.190	H
DWP-588					2.135	3.169	0.533	2.636	0.810	I
DWP-589	0.346	0.361	0.279	0.031	4.467	0.571	0.166	0.405	11.030	I
DWP-590					4.372	0.846	0.225	0.621	7.040	I
DWP-591					4.328	1.260	0.313	0.947	4.570	J
DWP-592					4.379	1.850	0.433	1.417	3.090	J
DWP-593					4.320	2.677	0.610	2.067	2.090	J
DWP-594	0.354	0.369	0.271	0.039	8.106	0.512	0.212	0.300	27.020	I
DWP-595					7.898	0.748	0.288	0.460	17.170	I
DWP-596					7.955	1.122	0.404	0.718	11.080	J
DWP-597					7.855	1.594	0.555	1.039	7.560	J
DWP-598					7.931	2.323	0.780	1.543	5.140	J
DWP-599	0.360	0.375	0.312	0.014	0.135	0.500	0.090	0.410	0.330	F
DWP-600					0.136	0.625	0.103	0.522	0.260	F
DWP-601					0.133	0.750	0.116	0.634	0.210	F
DWP-602					0.134	0.875	0.130	0.745	0.180	F
DWP-603					0.137	1.000	0.143	0.857	0.160	G
DWP-604					0.130	1.250	0.169	1.081	0.120	G
DWP-605	0.360	0.375	0.312	0.016	0.275	0.500	0.095	0.405	0.680	F
DWP-606					0.274	0.625	0.108	0.517	0.530	F
DWP-607					0.270	0.750	0.121	0.629	0.430	F
DWP-608					0.274	0.875	0.134	0.741	0.370	F
DWP-609					0.273	1.000	0.147	0.853	0.320	G
DWP-610					0.269	1.250	0.174	1.076	0.250	G
DWP-611	0.360	0.375	0.281	0.018	0.413	0.500	0.110	0.390	1.060	F
DWP-612					0.410	0.625	0.125	0.500	0.820	F
DWP-613					0.414	0.750	0.141	0.609	0.680	F
DWP-614					0.410	0.875	0.156	0.719	0.570	F
DWP-615					0.414	1.000	0.172	0.828	0.500	G
DWP-616					0.408	1.250	0.203	1.047	0.390	G

Wire size below .031 squared and not ground. Wire size .031 and above, squared with ground ends. Please inquire if you need a size not listed above.

STOCK PRECISION SPRINGS

316 Stainless Steel

Ends Squared and Ground
(See Below)

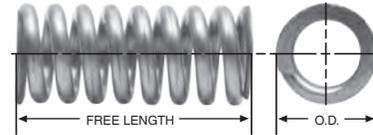

DIAMOND WIRE SPRING STOCK NO.	OUTSIDE DIAMETER	TO WORK IN HOLE DIA.	TO WORK OVER ROD DIA.	WIRE DIAMETER	APPROX. LOAD AT SOLID HT.	FREE LENGTH	SOLID HT.	TOTAL DEFLECTION	SPRING RATE	PRICE GROUP
	IN.	IN.	IN.	IN.	LB.	IN.	IN.	IN.	LB./IN.	
DWP-617	0.360	0.375	0.281	0.020	0.551	0.500	0.128	0.372	1.480	F
DWP-618					0.549	0.625	0.148	0.477	1.150	F
DWP-619					0.548	0.750	0.167	0.583	0.940	F
DWP-620					0.550	0.875	0.187	0.688	0.800	F
DWP-621					0.548	1.000	0.206	0.794	0.690	G
DWP-622					0.553	1.250	0.245	1.005	0.550	G
DWP-623	0.360	0.375	0.281	0.022	0.690	0.500	0.150	0.350	1.970	F
DWP-624					0.689	0.625	0.175	0.450	1.530	F
DWP-625					0.689	0.750	0.199	0.551	1.250	F
DWP-626					0.685	0.875	0.223	0.652	1.050	F
DWP-627					0.684	1.000	0.248	0.752	0.910	G
DWP-628					0.687	1.250	0.296	0.954	0.720	G
For additional size options see page 56										
DWP-629	0.364	0.379	0.261	0.049	22.272	0.591	0.264	0.327	68.110	J
DWP-630					21.300	0.866	0.364	0.502	42.430	J
DWP-631					22.018	1.299	0.505	0.794	27.730	J
DWP-632					22.080	1.870	0.698	1.172	18.840	J
DWP-633					22.203	2.717	0.981	1.736	12.790	K
DWP-634	0.375	0.391	0.312	0.016	0.148	0.500	0.120	0.380	0.390	F
DWP-635					0.146	0.625	0.140	0.485	0.300	F
DWP-636					0.148	0.750	0.159	0.591	0.250	F
DWP-637					0.146	0.875	0.179	0.696	0.210	F
DWP-638					0.144	1.000	0.199	0.801	0.180	G
DWP-639					0.142	1.250	0.239	1.011	0.140	G
DWP-640	0.375	0.391	0.312	0.018	0.296	0.500	0.120	0.380	0.780	F
DWP-641					0.297	0.625	0.138	0.487	0.610	F
DWP-642					0.297	0.750	0.157	0.593	0.500	F
DWP-643					0.294	0.875	0.175	0.700	0.420	F
DWP-644					0.299	1.000	0.193	0.807	0.370	G
DWP-645					0.296	1.250	0.230	1.020	0.290	G
DWP-646	0.375	0.391	0.312	0.020	0.448	0.500	0.133	0.367	1.220	F
DWP-647					0.447	0.625	0.154	0.471	0.950	F
DWP-648					0.449	0.750	0.174	0.576	0.780	F
DWP-649					0.449	0.875	0.195	0.680	0.660	F
DWP-650					0.447	1.000	0.216	0.784	0.570	G
DWP-651					0.447	1.250	0.257	0.993	0.450	G
DWP-652	0.375	0.391	0.312	0.022	0.600	0.500	0.151	0.349	1.720	F
DWP-653					0.597	0.625	0.176	0.449	1.330	F
DWP-654					0.600	0.750	0.200	0.550	1.090	F
DWP-655					0.598	0.875	0.225	0.650	0.920	F
DWP-656					0.601	1.000	0.249	0.751	0.800	G
DWP-657					0.600	1.250	0.298	0.952	0.630	G
DWP-658	0.375	0.391	0.281	0.024	0.751	0.500	0.172	0.328	2.290	F
DWP-659					0.749	0.625	0.202	0.423	1.770	F
DWP-660					0.747	0.750	0.231	0.519	1.440	F
DWP-661					0.750	0.875	0.260	0.615	1.220	F
DWP-662					0.746	1.000	0.290	0.710	1.050	G
DWP-663					0.749	1.250	0.348	0.902	0.830	G

PRECISION
SPRINGS

Wire size below .031 squared and not ground. Wire size .031 and above, squared with ground ends. Please inquire if you need a size not listed above.

STOCK PRECISION SPRINGS

316 Stainless Steel

Ends Squared and Ground
(See Below)

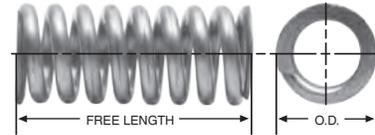

PRECISION SPRINGS

DIAMOND WIRE SPRING STOCK NO.	OUTSIDE DIAMETER	TO WORK IN HOLE DIA.	TO WORK OVER ROD DIA.	WIRE DIAMETER	APPROX. LOAD AT SOLID HT.	FREE LENGTH	SOLID HT.	TOTAL DEFLECTION	SPRING RATE	PRICE GROUP		
	IN.	IN.	IN.	IN.	LB.	IN.	IN.	IN.	LB./IN.			
DWP-664	0.378	0.393	0.247	0.063	39.177	0.571	0.350	0.221	177.270	K		
DWP-665					41.536	0.846	0.478	0.368	112.870	K		
DWP-666					41.899	1.240	0.668	0.572	73.250	L		
DWP-667					41.753	1.772	0.928	0.844	49.470	L		
DWP-668					42.550	2.579	1.310	1.269	33.530	M		
DWP-669	0.420	0.438	0.344	0.018	0.187	0.500	0.126	0.374	0.500	F		
DWP-670					0.187	0.625	0.146	0.479	0.390	F		
DWP-671					0.187	0.750	0.167	0.583	0.320	F		
DWP-672					0.186	0.875	0.187	0.688	0.270	F		
DWP-673					0.182	1.000	0.207	0.793	0.230	G		
DWP-674					0.180	1.250	0.248	1.002	0.180	G		
DWP-675	0.420	0.438	0.344	0.020	0.373	0.500	0.123	0.377	0.990	F		
DWP-676					0.373	0.625	0.140	0.485	0.770	F		
DWP-677					0.373	0.750	0.158	0.592	0.630	F		
DWP-678					0.370	0.875	0.176	0.699	0.530	F		
DWP-679					0.371	1.000	0.194	0.806	0.460	G		
DWP-680					0.368	1.250	0.229	1.021	0.360	G		
DWP-681	0.420	0.438	0.344	0.022	0.563	0.500	0.132	0.368	1.530	F		
DWP-682					0.563	0.625	0.152	0.473	1.190	F		
DWP-683					0.562	0.750	0.171	0.579	0.970	F		
DWP-684					0.562	0.875	0.190	0.685	0.820	F		
DWP-685					0.562	1.000	0.209	0.791	0.710	G		
DWP-686					0.562	1.250	0.247	1.003	0.560	G		
DWP-687	0.420	0.438	0.344	0.024	0.752	0.500	0.147	0.353	2.130	F		
DWP-688					0.752	0.625	0.169	0.456	1.650	F		
DWP-689					0.749	0.750	0.191	0.559	1.340	F		
DWP-690					0.748	0.875	0.213	0.662	1.130	F		
DWP-691					0.750	1.000	0.235	0.765	0.980	G		
DWP-692					0.748	1.250	0.279	0.971	0.770	G		
DWP-693	0.420	0.438	0.344	0.026	0.938	0.500	0.165	0.335	2.800	F		
DWP-694					0.940	0.625	0.190	0.435	2.160	F		
DWP-695					0.940	0.750	0.216	0.534	1.760	F		
DWP-696					0.938	0.875	0.241	0.634	1.480	F		
DWP-697					For additional size options see page 64		0.938	1.000	0.267	0.733	1.280	G
DWP-698							0.941	1.250	0.318	0.932	1.010	G
DWP-699	0.425	0.440	0.358	0.031	3.557	0.787	0.164	0.623	5.710	H		
DWP-700					3.455	1.181	0.224	0.957	3.610	I		
DWP-701					3.444	1.791	0.313	1.478	2.330	I		
DWP-702					3.396	2.598	0.435	2.163	1.570	J		
DWP-703					3.488	3.799	0.599	3.200	1.090	K		
DWP-704	0.433	0.448	0.350	0.039	6.578	0.689	0.212	0.477	13.790	H		
DWP-705					6.477	1.024	0.288	0.736	8.800	I		
DWP-706					6.475	1.535	0.401	1.134	5.710	I		
DWP-707					6.345	2.205	0.557	1.648	3.850	J		
DWP-708					6.359	3.209	0.782	2.427	2.620	K		
DWP-709	0.433	0.448	0.254	0.087	70.417	0.638	0.490	0.148	475.790	J		
DWP-710					70.731	0.906	0.672	0.234	302.270	J		

Wire size below .031 squared and not ground. Wire size .031 and above, squared with ground ends. Please inquire if you need a size not listed above.

STOCK PRECISION SPRINGS

316 Stainless Steel

Ends Squared and Ground
(See Below)

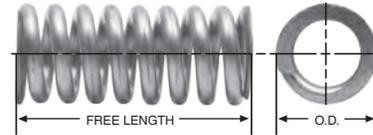

DIAMOND WIRE SPRING STOCK NO.	OUTSIDE DIAMETER	TO WORK IN HOLE DIA.	TO WORK OVER ROD DIA.	WIRE DIAMETER	APPROX. LOAD AT SOLID HT.	FREE LENGTH	SOLID HT.	TOTAL DEFLECTION	SPRING RATE	PRICE GROUP		
	IN.	IN.	IN.	IN.	LB.	IN.	IN.	IN.	LB./IN.			
DWP-711	0.433	0.448	0.254	0.087	71.025	1.437	1.032	0.405	175.370	L		
DWP-712					70.825	2.236	1.576	0.660	107.310	M		
DWP-713	0.443	0.458	0.340	0.049	16.995	0.787	0.283	0.504	33.720	J		
DWP-714					16.559	1.161	0.389	0.772	21.450	K		
DWP-715					16.737	1.752	0.547	1.205	13.890	K		
DWP-716					16.705	2.520	0.756	1.764	9.470	L		
DWP-717					16.587	3.681	1.077	2.604	6.370	M		
DWP-718					0.455	0.469	0.375	0.018	0.215	0.750	0.135	0.615
DWP-719	0.209	1.000	0.164	0.836					0.250	H		
DWP-720	0.211	1.250	0.193	1.057					0.200	H		
DWP-721	0.204	1.500	0.222	1.278					0.160	H		
DWP-722	0.210	1.750	0.251	1.499					0.140	H		
DWP-723	0.207	2.000	0.279	1.721					0.120	H		
DWP-724	0.455	0.469	0.375	0.020					0.428	0.750	0.130	0.620
DWP-725					0.431	1.000	0.155	0.845	0.510	H		
DWP-726					0.428	1.250	0.180	1.070	0.400	H		
DWP-727					0.427	1.500	0.206	1.294	0.330	H		
DWP-728					0.425	1.750	0.231	1.519	0.280	H		
DWP-729					0.419	2.000	0.256	1.744	0.240	H		
DWP-730					0.455	0.469	0.375	0.022	0.646	0.750	0.141	0.609
DWP-731	0.641	1.000	0.168	0.832					0.770	H		
DWP-732	0.644	1.250	0.195	1.055					0.610	H		
DWP-733	0.639	1.500	0.222	1.278					0.500	H		
DWP-734	0.645	1.750	0.250	1.500					0.430	H		
DWP-735	0.638	2.000	0.277	1.723					0.370	H		
DWP-736	0.455	0.469	0.375	0.024	0.860	0.750	0.157	0.593	1.450	G		
DWP-737					0.860	1.000	0.189	0.811	1.060	H		
DWP-738					0.855	1.250	0.220	1.030	0.830	H		
DWP-739					0.861	1.500	0.252	1.248	0.690	H		
DWP-740					0.851	1.750	0.283	1.467	0.580	H		
DWP-741					0.859	2.000	0.315	1.685	0.510	H		
DWP-742	0.455	0.469	0.375	0.026	1.075	0.750	0.178	0.572	1.880	G		
DWP-743					1.075	1.000	0.215	0.785	1.370	H		
DWP-744					1.078	1.250	0.252	0.998	1.080	H		
DWP-745					1.078	1.500	0.289	1.211	0.890	H		
DWP-746					For additional size options see page 67		1.068	1.750	0.326	1.424	0.750	H
DWP-747					For additional size options see page 67		1.080	2.000	0.363	1.637	0.660	H
DWP-748	0.457	0.472	0.326	0.063	34.466	0.728	0.349	0.379	90.940	J		
DWP-749					33.894	1.063	0.477	0.586	57.840	K		
DWP-750					34.660	1.594	0.668	0.926	37.430	K		
DWP-751					34.907	2.303	0.926	1.377	25.350	L		
DWP-752					35.010	3.346	1.307	2.039	17.170	M		
DWP-753	0.472	0.487	0.309	0.079	58.711	0.709	0.444	0.265	221.550	J		
DWP-754					61.752	1.043	0.606	0.437	141.310	K		
DWP-755					60.794	1.516	0.851	0.665	91.420	K		
DWP-756					61.090	2.165	1.180	0.985	62.020	L		
DWP-757					61.174	3.130	1.670	1.460	41.900	M		

PRECISION
SPRINGS

Wire size below .031 squared and not ground. Wire size .031 and above, squared with ground ends. Please inquire if you need a size not listed above.

STOCK PRECISION SPRINGS

316 Stainless Steel

Ends Squared and Ground
(See Below)

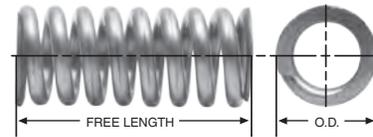

PRECISION SPRINGS

DIAMOND WIRE SPRING STOCK NO.	OUTSIDE DIAMETER	TO WORK IN HOLE DIA.	TO WORK OVER ROD DIA.	WIRE DIAMETER	APPROX. LOAD AT SOLID HT.	FREE LENGTH	SOLID HT.	TOTAL DEFLECTION	SPRING RATE	PRICE GROUP
	IN.	IN.	IN.	IN.	LB.	IN.	IN.	IN.	LB./IN.	
DWP-758	0.480	0.500	0.406	0.020	0.242	0.750	0.159	0.591	0.410	G
DWP-759					0.242	1.000	0.195	0.805	0.300	H
DWP-760					0.245	1.250	0.231	1.019	0.240	H
DWP-761					0.234	1.500	0.267	1.233	0.190	H
DWP-762					0.246	1.750	0.302	1.448	0.170	H
DWP-763					0.233	2.000	0.338	1.662	0.140	H
DWP-764	0.480	0.500	0.406	0.022	0.488	0.750	0.148	0.602	0.810	G
DWP-765					0.485	1.000	0.178	0.822	0.590	H
DWP-766					0.490	1.250	0.208	1.042	0.470	H
DWP-767					0.480	1.500	0.238	1.262	0.380	H
DWP-768					0.489	1.750	0.268	1.482	0.330	H
DWP-769					0.477	2.000	0.298	1.702	0.280	H
DWP-770	0.480	0.500	0.406	0.024	0.735	0.750	0.157	0.593	1.240	G
DWP-771					0.731	1.000	0.188	0.812	0.900	H
DWP-772					0.732	1.250	0.219	1.031	0.710	H
DWP-773					0.725	1.500	0.250	1.250	0.580	H
DWP-774					0.735	1.750	0.281	1.469	0.500	H
DWP-775					0.725	2.000	0.313	1.687	0.430	H
DWP-776	0.480	0.500	0.406	0.026	0.977	0.750	0.172	0.578	1.690	G
DWP-777					0.977	1.000	0.206	0.794	1.230	H
DWP-778					0.979	1.250	0.241	1.009	0.970	H
DWP-779					0.979	1.500	0.276	1.224	0.800	H
DWP-780					0.979	1.750	0.311	1.439	0.680	H
DWP-781					0.976	2.000	0.345	1.655	0.590	H
DWP-782	0.480	0.500	0.375	0.029	1.226	0.750	0.210	0.540	2.270	G
DWP-783					1.228	1.000	0.256	0.744	1.650	H
DWP-784					1.222	1.250	0.303	0.947	1.290	H
DWP-785					1.220	1.500	0.349	1.151	1.060	H
DWP-786					1.220	1.750	0.395	1.355	0.900	H
DWP-787					1.215	2.000	0.442	1.558	0.780	H
For additional size options see page 68										
DWP-788	0.531	0.546	0.448	0.039	5.197	0.945	0.212	0.733	7.090	K
DWP-789					5.193	1.437	0.288	1.149	4.520	L
DWP-790					5.162	2.185	0.405	1.780	2.900	L
DWP-791					5.080	3.169	0.564	2.605	1.950	M
DWP-792					4.972	4.528	0.790	3.738	1.330	M
DWP-793	0.540	0.562	0.469	0.022	0.309	0.750	0.155	0.595	0.520	G
DWP-794					0.309	1.000	0.187	0.813	0.380	H
DWP-795					0.309	1.250	0.220	1.030	0.300	H
DWP-796					0.300	1.500	0.252	1.248	0.240	H
DWP-797					0.308	1.750	0.285	1.465	0.210	H
DWP-798					0.303	2.000	0.317	1.683	0.180	H
DWP-799	0.540	0.562	0.469	0.024	0.619	0.750	0.143	0.607	1.020	G
DWP-800					0.615	1.000	0.169	0.831	0.740	H
DWP-801					0.612	1.250	0.195	1.055	0.580	H
DWP-802					0.614	1.500	0.221	1.279	0.480	H
DWP-803					0.616	1.750	0.248	1.502	0.410	H
DWP-804					0.604	2.000	0.274	1.726	0.350	H

Wire size below .031 squared and not ground. Wire size .031 and above, squared with ground ends. Please inquire if you need a size not listed above.

STOCK PRECISION SPRINGS

316 Stainless Steel

Ends Squared and Ground
(See Below)

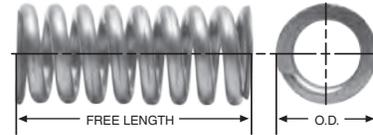

DIAMOND WIRE SPRING STOCK NO.	OUTSIDE DIAMETER	TO WORK IN HOLE DIA.	TO WORK OVER ROD DIA.	WIRE DIAMETER	APPROX. LOAD AT SOLID HT.	FREE LENGTH	SOLID HT.	TOTAL DEFLECTION	SPRING RATE	PRICE GROUP		
	IN.	IN.	IN.	IN.	LB.	IN.	IN.	IN.	LB./IN.			
DWP-805	0.540	0.562	0.438	0.026	0.926	0.750	0.149	0.601	1.540	G		
DWP-806					0.924	1.000	0.175	0.825	1.120	H		
DWP-807					0.923	1.250	0.201	1.049	0.880	H		
DWP-808					0.929	1.500	0.228	1.272	0.730	H		
DWP-809					0.928	1.750	0.254	1.496	0.620	H		
DWP-810					0.929	2.000	0.280	1.720	0.540	H		
DWP-811	0.540	0.562	0.438	0.029	1.240	0.750	0.176	0.574	2.160	G		
DWP-812					1.234	1.000	0.209	0.791	1.560	H		
DWP-813					1.239	1.250	0.243	1.007	1.230	H		
DWP-814					1.235	1.500	0.277	1.223	1.010	H		
DWP-815					1.238	1.750	0.310	1.440	0.860	H		
DWP-816					1.225	2.000	0.344	1.656	0.740	H		
DWP-817	0.540	0.562	0.438	0.032	1.642	0.750	0.176	0.574	2.860	G		
DWP-818					1.609	1.000	0.219	0.781	2.060	H		
DWP-819					1.602	1.250	0.261	0.989	1.620	H		
DWP-820					1.591	1.500	0.304	1.196	1.330	H		
DWP-821					For additional size options see page 73		1.585	1.750	0.347	1.403	1.130	H
DWP-822							1.578	2.000	0.390	1.610	0.980	H
DWP-823	0.555	0.570	0.424	0.063	27.620	0.945	0.350	0.595	46.420	J		
DWP-824					27.823	1.417	0.478	0.939	29.630	K		
DWP-825					27.638	2.106	0.668	1.438	19.220	K		
DWP-826					27.838	3.071	0.928	2.143	12.990	L		
DWP-827					28.105	4.528	1.316	3.212	8.750	M		
DWP-828	0.571	0.586	0.408	0.079	50.536	0.886	0.442	0.444	113.820	J		
DWP-829					50.176	1.299	0.605	0.694	72.300	K		
DWP-830					51.279	1.949	0.850	1.099	46.660	K		
DWP-831					51.612	2.795	1.173	1.622	31.820	L		
DWP-832					53.191	4.134	1.660	2.474	21.500	M		
DWP-833	0.591	0.606	0.412	0.087	46.008	0.787	0.489	0.298	154.390	K		
DWP-834					51.173	1.189	0.669	0.520	98.410	L		
DWP-835					50.973	1.925	1.029	0.896	56.890	M		
DWP-836	0.600	0.625	0.500	0.024	0.382	0.750	0.153	0.597	0.640	G		
DWP-837					0.376	1.000	0.183	0.817	0.460	H		
DWP-838					0.384	1.250	0.213	1.037	0.370	H		
DWP-839					0.377	1.500	0.243	1.257	0.300	H		
DWP-840					0.384	1.750	0.273	1.477	0.260	H		
DWP-841					0.373	2.000	0.303	1.697	0.220	H		
DWP-842	0.600	0.625	0.500	0.026	0.763	0.750	0.140	0.610	1.250	G		
DWP-843					0.761	1.000	0.164	0.836	0.910	H		
DWP-844					0.765	1.250	0.187	1.063	0.720	H		
DWP-845					0.761	1.500	0.210	1.290	0.590	H		
DWP-846					0.759	1.750	0.233	1.517	0.500	H		
DWP-847					0.767	2.000	0.257	1.743	0.440	H		
DWP-848	0.600	0.625	0.500	0.029	1.148	0.750	0.158	0.592	1.940	G		
DWP-849					1.149	1.000	0.185	0.815	1.410	H		
DWP-850					1.143	1.250	0.211	1.039	1.100	H		

PRECISION
SPRINGS

Wire size below .031 squared and not ground. Wire size .031 and above, squared with ground ends. Please inquire if you need a size not listed above.

STOCK PRECISION SPRINGS

316 Stainless Steel

Ends Squared and Ground
(See Below)

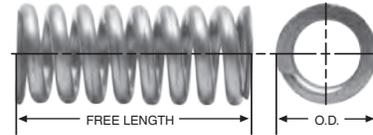

PRECISION SPRINGS

DIAMOND WIRE SPRING STOCK NO.	OUTSIDE DIAMETER	TO WORK IN HOLE DIA.	TO WORK OVER ROD DIA.	WIRE DIAMETER	APPROX. LOAD AT SOLID HT.	FREE LENGTH	SOLID HT.	TOTAL DEFLECTION	SPRING RATE	PRICE GROUP		
	IN.	IN.	IN.	IN.	LB.	IN.	IN.	IN.	LB./IN.			
DWP-851	0.600	0.625	0.500	0.029	1.148	1.500	0.238	1.262	0.910	H		
DWP-852					1.143	1.750	0.265	1.485	0.770	H		
DWP-853					1.144	2.000	0.292	1.708	0.670	H		
DWP-854	0.600	0.625	0.500	0.032	1.617	0.750	0.149	0.601	2.690	G		
DWP-855					1.597	1.000	0.181	0.819	1.950	H		
DWP-856					1.575	1.250	0.214	1.036	1.520	H		
DWP-857					1.568	1.500	0.246	1.254	1.250	H		
DWP-858					1.559	1.750	0.279	1.471	1.060	H		
DWP-859					1.554	2.000	0.311	1.689	0.920	H		
DWP-860					0.600	0.625	0.500	0.035	2.037	0.750	0.173	0.577
DWP-861	1.999	1.000	0.213	0.787					2.540	H		
DWP-862	1.984	1.250	0.253	0.997					1.990	H		
DWP-863	1.967	1.500	0.293	1.207					1.630	H		
DWP-864	For additional size options see page 75		1.957	1.750					0.332	1.418	1.380	H
DWP-865	1.954	2.000	0.372	1.628					1.200	H		
DWP-866	0.660	0.687	0.562	0.026	0.460	0.750	0.153	0.597	0.770	I		
DWP-867					0.459	1.000	0.181	0.819	0.560	J		
DWP-868					0.458	1.250	0.209	1.041	0.440	J		
DWP-869					0.455	1.500	0.237	1.263	0.360	J		
DWP-870					0.460	1.750	0.265	1.485	0.310	J		
DWP-871					0.461	2.000	0.293	1.707	0.270	J		
DWP-872	0.660	0.687	0.562	0.029	0.925	0.750	0.153	0.597	1.550	I		
DWP-873					0.921	1.000	0.178	0.822	1.120	J		
DWP-874					0.922	1.250	0.202	1.048	0.880	J		
DWP-875					0.917	1.500	0.227	1.273	0.720	J		
DWP-876					0.914	1.750	0.252	1.498	0.610	J		
DWP-877					0.913	2.000	0.277	1.723	0.530	J		
DWP-878	0.660	0.687	0.562	0.032	1.464	0.750	0.135	0.615	2.380	I		
DWP-879					1.441	1.000	0.162	0.838	1.720	J		
DWP-880					1.432	1.250	0.189	1.061	1.350	J		
DWP-881					1.425	1.500	0.216	1.284	1.110	J		
DWP-882					1.416	1.750	0.244	1.506	0.940	J		
DWP-883					1.400	2.000	0.271	1.729	0.810	J		
DWP-884	0.660	0.687	0.562	0.035	1.967	0.750	0.152	0.598	3.290	I		
DWP-885					1.936	1.000	0.183	0.817	2.370	J		
DWP-886					1.915	1.250	0.215	1.035	1.850	J		
DWP-887					1.905	1.500	0.247	1.253	1.520	J		
DWP-888					1.899	1.750	0.278	1.472	1.290	J		
DWP-889					1.893	2.000	0.310	1.690	1.120	J		
DWP-890	0.660	0.687	0.531	0.038	2.480	0.750	0.172	0.578	4.290	I		
DWP-891					2.425	1.000	0.210	0.790	3.070	J		
DWP-892					2.407	1.250	0.247	1.003	2.400	J		
DWP-893					2.381	1.500	0.285	1.215	1.960	J		
DWP-894					For additional size options see page 78		2.369	1.750	0.323	1.427	1.660	J
DWP-895	0.679	0.694	0.576	0.049	10.897	1.594	0.270	1.324	8.230	J		
DWP-896					10.842	2.441	0.368	2.073	5.230	M		
DWP-897					10.910	3.701	0.511	3.190	3.420	M		

Wire size below .031 squared and not ground. Wire size .031 and above, squared with ground ends. Please inquire if you need a size not listed above.

STOCK PRECISION SPRINGS

316 Stainless Steel

Ends Squared and Ground
(See Below)

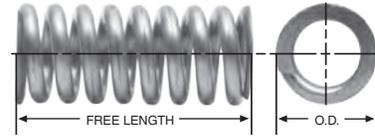

DIAMOND WIRE SPRING STOCK NO.	OUTSIDE DIAMETER	TO WORK IN HOLE DIA.	TO WORK OVER ROD DIA.	WIRE DIAMETER	APPROX. LOAD AT SOLID HT.	FREE LENGTH	SOLID HT.	TOTAL DEFLECTION	SPRING RATE	PRICE GROUP		
	IN.	IN.	IN.	IN.	LB.	IN.	IN.	IN.	LB./IN.			
DWP-898	0.679	0.694	0.576	0.049	10.933	5.512	0.717	4.795	2.280	N		
DWP-899					10.707	8.071	1.027	7.044	1.520	R		
DWP-900	0.693	0.708	0.562	0.063	21.877	1.339	0.350	0.989	22.120	M		
DWP-901					21.824	2.028	0.478	1.550	14.080	N		
DWP-902					21.748	3.051	0.669	2.382	9.130	N		
DWP-903					21.024	4.331	0.929	3.402	6.180	O		
DWP-904					21.729	6.496	1.310	5.186	4.190	Q		
DWP-905	0.709	0.724	0.546	0.079	40.002	1.181	0.442	0.739	54.130	N		
DWP-906					40.191	1.772	0.605	1.167	34.440	N		
DWP-907					40.827	2.677	0.847	1.830	22.310	O		
DWP-908					40.747	3.858	1.172	2.686	15.170	P		
DWP-909					41.624	5.709	1.656	4.053	10.270	Q		
DWP-910	0.720	0.750	0.625	0.029	0.552	0.750	0.169	0.581	0.950	J		
DWP-911					0.552	1.000	0.200	0.800	0.690	K		
DWP-912					0.551	1.250	0.230	1.020	0.540	K		
DWP-913					0.545	1.500	0.261	1.239	0.440	K		
DWP-914					0.539	1.750	0.292	1.458	0.370	K		
DWP-915					0.537	2.000	0.323	1.677	0.320	K		
DWP-916	0.720	0.750	0.625	0.032	1.162	0.750	0.132	0.618	1.880	J		
DWP-917					1.145	1.000	0.158	0.842	1.360	K		
DWP-918					1.129	1.250	0.185	1.065	1.060	K		
DWP-919					1.121	1.500	0.211	1.289	0.870	K		
DWP-920					1.120	1.750	0.237	1.513	0.740	K		
DWP-921					1.112	2.000	0.263	1.737	0.640	K		
DWP-922	0.720	0.750	0.594	0.035	1.754	0.750	0.141	0.609	2.880	J		
DWP-923					1.722	1.000	0.168	0.832	2.070	K		
DWP-924					1.707	1.250	0.196	1.054	1.620	K		
DWP-925					1.698	1.500	0.223	1.277	1.330	K		
DWP-926					1.694	1.750	0.251	1.499	1.130	K		
DWP-927					1.688	2.000	0.278	1.722	0.980	K		
DWP-928	0.720	0.750	0.594	0.038	2.356	0.750	0.155	0.595	3.960	J		
DWP-929					2.312	1.000	0.186	0.814	2.840	K		
DWP-930					2.283	1.250	0.217	1.033	2.210	K		
DWP-931					2.266	1.500	0.248	1.252	1.810	K		
DWP-932					2.265	1.750	0.279	1.471	1.540	K		
DWP-933					2.248	2.000	0.310	1.690	1.330	K		
DWP-934	0.720	0.750	0.594	0.042	2.977	0.750	0.184	0.566	5.260	J		
DWP-935					2.914	1.000	0.223	0.777	3.750	K		
DWP-936					2.882	1.250	0.263	0.987	2.920	K		
DWP-937					2.861	1.500	0.303	1.197	2.390	K		
DWP-938					For additional size options see page 80		2.842	1.750	0.343	1.407	2.020	K
DWP-939							2.830	2.000	0.383	1.617	1.750	K
DWP-940	0.845	0.875	0.719	0.035	0.780	1.000	0.196	0.804	0.970	N		
DWP-941					0.774	1.250	0.232	1.018	0.760	N		
DWP-942					0.764	1.500	0.267	1.233	0.620	N		
DWP-943					0.767	1.750	0.302	1.448	0.530	N		
DWP-944					0.765	2.000	0.337	1.663	0.460	O		
DWP-945					0.751	2.250	0.373	1.877	0.400	O		

PRECISION
SPRINGS

Wire size below .031 squared and not ground. Wire size .031 and above, squared with ground ends. Please inquire if you need a size not listed above.

STOCK PRECISION SPRINGS

316 Stainless Steel

Ends Squared and Ground
(See Below)

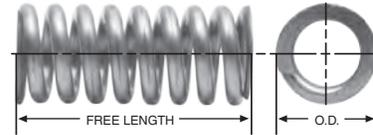

PRECISION SPRINGS

DIAMOND WIRE SPRING STOCK NO.	OUTSIDE DIAMETER	TO WORK IN HOLE DIA.	TO WORK OVER ROD DIA.	WIRE DIAMETER	APPROX. LOAD AT SOLID HT.	FREE LENGTH	SOLID HT.	TOTAL DEFLECTION	SPRING RATE	PRICE GROUP
	IN.	IN.	IN.	IN.	LB.	IN.	IN.	IN.	LB./IN.	
DWP-946	0.845	0.875	0.719	0.038	1.568	1.000	0.175	0.825	1.900	N
DWP-947					1.550	1.250	0.203	1.047	1.480	N
DWP-948					1.549	1.500	0.230	1.270	1.220	N
DWP-949					1.537	1.750	0.258	1.492	1.030	N
DWP-950					1.525	2.000	0.286	1.714	0.890	O
DWP-951					1.529	2.250	0.314	1.936	0.790	O
DWP-952	0.845	0.875	0.719	0.042	2.378	1.000	0.191	0.809	2.940	N
DWP-953					2.344	1.250	0.222	1.028	2.280	N
DWP-954					2.332	1.500	0.253	1.247	1.870	N
DWP-955					2.318	1.750	0.283	1.467	1.580	N
DWP-956					2.310	2.000	0.314	1.686	1.370	O
DWP-957					2.305	2.250	0.345	1.905	1.210	O
DWP-958	0.845	0.875	0.719	0.045	3.180	1.000	0.203	0.797	3.990	N
DWP-959					3.147	1.250	0.235	1.015	3.100	N
DWP-960					3.117	1.500	0.268	1.232	2.530	N
DWP-961					3.103	1.750	0.300	1.450	2.140	N
DWP-962					3.084	2.000	0.333	1.667	1.850	O
DWP-963					3.071	2.250	0.366	1.884	1.630	O
DWP-964	0.845	0.875	0.688	0.049	4.009	1.000	0.232	0.768	5.220	N
DWP-965					3.955	1.250	0.271	0.979	4.040	N
DWP-966					3.915	1.500	0.310	1.190	3.290	N
DWP-967					3.892	1.750	0.350	1.400	2.780	N
DWP-968					3.866	2.000	0.389	1.611	2.400	O
DWP-969					3.863	2.250	0.428	1.822	2.120	O
DWP-970	0.866	0.881	0.703	0.079	32.472	1.614	0.443	1.171	27.730	O
DWP-971					32.405	2.441	0.605	1.836	17.650	O
DWP-972					32.393	3.701	0.852	2.849	11.370	P
DWP-973					32.077	5.315	1.176	4.139	7.750	R
DWP-974					32.463	7.874	1.667	6.207	5.230	S
DWP-975	0.945	0.960	0.766	0.087	32.906	1.543	0.490	1.053	31.250	P
DWP-976					33.044	2.327	0.669	1.658	19.930	Q
DWP-977	0.970	1.000	0.844	0.042	1.021	1.250	0.278	0.972	1.050	U
DWP-978					1.014	1.500	0.321	1.179	0.860	U
DWP-979					1.012	1.750	0.364	1.386	0.730	U
DWP-980					1.004	2.000	0.407	1.593	0.630	W
DWP-981					0.990	2.250	0.450	1.800	0.550	W
DWP-982					1.004	2.500	0.493	2.007	0.500	W
DWP-983	0.970	1.000	0.844	0.045	2.052	1.250	0.234	1.016	2.020	U
DWP-984					2.036	1.500	0.266	1.234	1.650	U
DWP-985					2.017	1.750	0.299	1.451	1.390	U
DWP-986					2.003	2.000	0.331	1.669	1.200	W
DWP-987					2.000	2.250	0.363	1.887	1.060	W
DWP-988					1.999	2.500	0.396	2.104	0.950	W
DWP-989	0.970	1.000	0.812	0.049	3.095	1.250	0.245	1.005	3.080	U
DWP-990					3.067	1.500	0.278	1.222	2.510	U
DWP-991					3.036	1.750	0.311	1.439	2.110	U
DWP-992					3.029	2.000	0.345	1.655	1.830	W

Wire size below .031 squared and not ground. Wire size .031 and above, squared with ground ends. Please inquire if you need a size not listed above.

STOCK PRECISION SPRINGS

316 Stainless Steel

Ends Squared and Ground
(See Below)

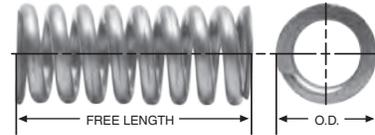

DIAMOND WIRE SPRING STOCK NO.	OUTSIDE DIAMETER	TO WORK IN HOLE DIA.	TO WORK OVER ROD DIA.	WIRE DIAMETER	APPROX. LOAD AT SOLID HT.	FREE LENGTH	SOLID HT.	TOTAL DEFLECTION	SPRING RATE	PRICE GROUP
	IN.	IN.	IN.	IN.	LB.	IN.	IN.	IN.	LB./IN.	
DWP-993	0.970	1.000	0.812	0.049	3.014	2.250	0.378	1.872	1.610	W
DWP-994					3.008	2.500	0.411	2.089	1.440	W
DWP-995	0.970	1.000	0.812	0.055	4.160	1.250	0.298	0.952	4.370	U
DWP-996					4.114	1.500	0.341	1.159	3.550	U
DWP-997					4.084	1.750	0.384	1.366	2.990	U
DWP-998					4.058	2.000	0.427	1.573	2.580	W
DWP-999					4.038	2.250	0.471	1.779	2.270	W
DWP-1000					4.032	2.500	0.514	1.986	2.030	W
DWP-1001	0.970	1.000	0.812	0.059	5.239	1.250	0.326	0.924	5.670	U
DWP-1002					5.175	1.500	0.375	1.125	4.600	U
DWP-1003					5.135	1.750	0.423	1.327	3.870	U
DWP-1004					5.104	2.000	0.472	1.528	3.340	W
DWP-1005					5.069	2.250	0.520	1.730	2.930	W
DWP-1006					5.059	2.500	0.569	1.931	2.620	W
DWP-1007	1.063	1.078	0.900	0.079	26.073	2.283	0.443	1.840	14.170	Y
DWP-1008					26.026	3.484	0.605	2.879	9.040	Z
DWP-1009					26.097	5.315	0.854	4.461	5.850	AA
DWP-1010					25.663	7.677	1.180	6.497	3.950	AB
DWP-1011					26.474	11.417	1.648	9.769	2.710	AF
DWP-1012	1.095	1.125	0.969	0.045	1.282	1.500	0.279	1.221	1.050	U
DWP-1013					1.279	1.750	0.313	1.437	0.890	U
DWP-1014					1.272	2.000	0.348	1.652	0.770	U
DWP-1015					1.270	2.250	0.382	1.868	0.680	W
DWP-1016					1.271	2.500	0.417	2.083	0.610	W
DWP-1017					1.264	2.750	0.451	2.299	0.550	W
DWP-1018	1.095	1.125	0.938	0.049	2.581	1.500	0.247	1.253	2.060	U
DWP-1019					2.567	1.750	0.275	1.475	1.740	U
DWP-1020					2.546	2.000	0.303	1.697	1.500	U
DWP-1021					2.534	2.250	0.330	1.920	1.320	W
DWP-1022					2.528	2.500	0.358	2.142	1.180	W
DWP-1023					2.531	2.750	0.385	2.365	1.070	W
DWP-1024	1.095	1.125	0.938	0.055	3.903	1.500	0.284	1.216	3.210	U
DWP-1025					3.869	1.750	0.317	1.433	2.700	U
DWP-1026					3.847	2.000	0.349	1.651	2.330	U
DWP-1027					3.829	2.250	0.382	1.868	2.050	W
DWP-1028					3.816	2.500	0.415	2.085	1.830	W
DWP-1029					3.800	2.750	0.447	2.303	1.650	W
DWP-1030	1.095	1.125	0.938	0.059	5.223	1.500	0.302	1.198	4.360	U
DWP-1031					5.186	1.750	0.337	1.413	3.670	U
DWP-1032					5.144	2.000	0.372	1.628	3.160	U
DWP-1033					5.124	2.250	0.407	1.843	2.780	W
DWP-1034					5.106	2.500	0.441	2.059	2.480	W
DWP-1035					5.094	2.750	0.476	2.274	2.240	W
DWP-1036	1.095	1.125	0.938	0.063	6.563	1.500	0.328	1.172	5.600	U
DWP-1037					6.505	1.750	0.366	1.384	4.700	U
DWP-1038					6.464	2.000	0.404	1.596	4.050	U
DWP-1039					6.433	2.250	0.443	1.807	3.560	W

PRECISION
SPRINGS

Wire size below .031 squared and not ground. Wire size .031 and above, squared with ground ends. Please inquire if you need a size not listed above.

STOCK PRECISION SPRINGS

316 Stainless Steel

Ends Squared and Ground
(See Below)

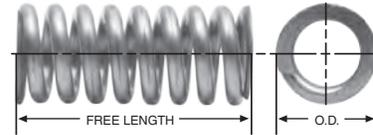

PRECISION SPRINGS

DIAMOND WIRE SPRING STOCK NO.	OUTSIDE DIAMETER	TO WORK IN HOLE DIA.	TO WORK OVER ROD DIA.	WIRE DIAMETER	APPROX. LOAD AT SOLID HT.	FREE LENGTH	SOLID HT.	TOTAL DEFLECTION	SPRING RATE	PRICE GROUP
	IN.	IN.	IN.	IN.	LB.	IN.	IN.	IN.	LB./IN.	
DWP-1040	1.095	1.125	0.938	0.063	6.400	2.500	0.481	2.019	3.170	W
DWP-1041					6.378	2.750	0.520	2.230	2.860	W
DWP-1042	1.218	1.250	1.062	0.055	1.604	1.500	0.386	1.114	1.440	U
DWP-1043					1.601	1.750	0.438	1.312	1.220	U
DWP-1044					1.587	2.000	0.489	1.511	1.050	U
DWP-1045					1.572	2.250	0.541	1.709	0.920	W
DWP-1046					1.564	2.500	0.593	1.907	0.820	W
DWP-1047					1.558	2.750	0.645	2.105	0.740	W
DWP-1048					1.218	1.250	1.062	0.059	3.226	1.500
DWP-1049	3.197	1.750	0.366	1.384					2.310	U
DWP-1050	3.174	2.000	0.405	1.595					1.990	U
DWP-1051	3.159	2.250	0.445	1.805					1.750	W
DWP-1052	3.145	2.500	0.484	2.016					1.560	W
DWP-1053	3.139	2.750	0.524	2.226					1.410	W
DWP-1054	1.218	1.250	1.031	0.063					4.857	1.500
DWP-1055					4.816	1.750	0.358	1.392	3.460	U
DWP-1056					4.780	2.000	0.396	1.604	2.980	U
DWP-1057					4.761	2.250	0.433	1.817	2.620	W
DWP-1058					4.750	2.500	0.470	2.030	2.340	W
DWP-1059					4.733	2.750	0.507	2.243	2.110	W
DWP-1060	1.218	1.250	1.031	0.067	6.500	1.500	0.333	1.167	5.570	U
DWP-1061					6.440	1.750	0.371	1.379	4.670	U
DWP-1062					6.396	2.000	0.409	1.591	4.020	U
DWP-1063					6.365	2.250	0.447	1.803	3.530	W
DWP-1064					6.347	2.500	0.485	2.015	3.150	W
DWP-1065					6.322	2.750	0.524	2.226	2.840	W
DWP-1066	1.218	1.250	1.031	0.072	8.187	1.500	0.366	1.134	7.220	U
DWP-1067					8.094	1.750	0.410	1.340	6.040	U
DWP-1068					8.044	2.000	0.453	1.547	5.200	U
DWP-1069					7.998	2.250	0.496	1.754	4.560	W
DWP-1070					7.958	2.500	0.540	1.960	4.060	W
DWP-1071					7.931	2.750	0.583	2.167	3.660	W
DWP-1072	1.400	1.437	1.219	0.063	2.148	1.500	0.393	1.107	1.940	W
DWP-1073					2.129	1.750	0.444	1.306	1.630	W
DWP-1074					2.107	2.000	0.495	1.505	1.400	Y
DWP-1075					2.096	2.250	0.546	1.704	1.230	Y
DWP-1076					2.093	2.500	0.597	1.903	1.100	Y
DWP-1077					2.081	2.750	0.648	2.102	0.990	Y
DWP-1078	1.400	1.437	1.219	0.067	4.301	1.500	0.328	1.172	3.670	W
DWP-1079					4.249	1.750	0.366	1.384	3.070	W
DWP-1080					4.232	2.000	0.403	1.597	2.650	Y
DWP-1081					4.199	2.250	0.440	1.810	2.320	Y
DWP-1082					4.186	2.500	0.478	2.022	2.070	Y
DWP-1083					4.179	2.750	0.515	2.235	1.870	Y
DWP-1084	1.400	1.437	1.219	0.072	6.482	1.500	0.330	1.170	5.540	W
DWP-1085					6.403	1.750	0.367	1.383	4.630	W
DWP-1086					6.356	2.000	0.403	1.597	3.980	Y
DWP-1087					6.320	2.250	0.439	1.811	3.490	Y

Wire size below .031 squared and not ground. Wire size .031 and above, squared with ground ends. Please inquire if you need a size not listed above.

STOCK PRECISION SPRINGS

316 Stainless Steel

Ends Squared and Ground
(See Below)

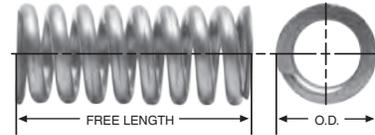

DIAMOND WIRE SPRING STOCK NO.	OUTSIDE DIAMETER	TO WORK IN HOLE DIA.	TO WORK OVER ROD DIA.	WIRE DIAMETER	APPROX. LOAD AT SOLID HT.	FREE LENGTH	SOLID HT.	TOTAL DEFLECTION	SPRING RATE	PRICE GROUP				
	IN.	IN.	IN.	IN.	LB.	IN.	IN.	IN.	LB./IN.					
DWP-1088	1.400	1.437	1.219	0.072	6.295	2.500	0.476	2.024	3.110	Y				
DWP-1089					6.266	2.750	0.512	2.238	2.800	Y				
DWP-1090	1.400	1.437	1.188	0.080	8.726	1.500	0.387	1.113	7.840	W				
DWP-1091					8.633	1.750	0.432	1.318	6.550	W				
DWP-1092					8.544	2.000	0.477	1.523	5.610	Y				
DWP-1093					8.502	2.250	0.522	1.728	4.920	Y				
DWP-1094					8.447	2.500	0.567	1.933	4.370	Y				
DWP-1095					8.424	2.750	0.612	2.138	3.940	Y				
DWP-1096	1.400	1.437	1.188	0.085	10.999	1.500	0.411	1.089	10.100	W				
DWP-1097					10.849	1.750	0.460	1.290	8.410	W				
DWP-1098					10.742	2.000	0.508	1.492	7.200	Y				
DWP-1099					10.666	2.250	0.557	1.693	6.300	Y				
DWP-1100					10.612	2.500	0.605	1.895	5.600	Y				
DWP-1101					10.564	2.750	0.654	2.096	5.040	Y				
DWP-1102	1.460	1.500	1.281	0.067	2.342	1.625	0.448	1.177	1.990	W				
DWP-1103					2.321	1.750	0.475	1.275	1.820	W				
DWP-1104					2.308	2.000	0.530	1.470	1.570	Y				
DWP-1105					2.296	2.250	0.586	1.664	1.380	Y				
DWP-1106					2.287	2.500	0.641	1.859	1.230	Y				
DWP-1107					2.280	2.750	0.696	2.054	1.110	Y				
DWP-1108	1.460	1.500	1.250	0.072	4.682	1.625	0.383	1.242	3.770	W				
DWP-1109					4.667	1.750	0.405	1.345	3.470	W				
DWP-1110					4.628	2.000	0.447	1.553	2.980	Y				
DWP-1111					4.594	2.250	0.490	1.760	2.610	Y				
DWP-1112					4.585	2.500	0.532	1.968	2.330	Y				
DWP-1113					4.568	2.750	0.575	2.175	2.100	Y				
DWP-1114	1.460	1.500	1.250	0.080	7.098	1.625	0.424	1.201	5.910	W				
DWP-1115					7.057	1.750	0.448	1.302	5.420	W				
DWP-1116					6.998	2.000	0.495	1.505	4.650	Y				
DWP-1117					6.947	2.250	0.543	1.707	4.070	Y				
DWP-1118					6.914	2.500	0.590	1.910	3.620	Y				
DWP-1119					6.885	2.750	0.638	2.112	3.260	Y				
DWP-1120	1.460	1.500	1.250	0.085	9.512	1.625	0.436	1.189	8.000	W				
DWP-1121					9.448	1.750	0.461	1.289	7.330	W				
DWP-1122					9.363	2.000	0.509	1.491	6.280	Y				
DWP-1123					9.289	2.250	0.558	1.692	5.490	Y				
DWP-1124					9.238	2.500	0.607	1.893	4.880	Y				
DWP-1125					9.197	2.750	0.655	2.095	4.390	Y				
DWP-1126	1.460	1.500	1.219	0.092	12.018	1.625	0.488	1.137	10.570	W				
DWP-1127					11.923	1.750	0.517	1.233	9.670	W				
DWP-1128					11.801	2.000	0.573	1.427	8.270	Y				
DWP-1129					11.704	2.250	0.629	1.621	7.220	Y				
DWP-1130					For additional size options see page 95				11.628	2.500	0.686	1.814	6.410	Y
DWP-1131									11.566	2.750	0.742	2.008	5.760	Y
DWP-1132	1.580	1.625	1.375	0.067	2.715	1.750	0.379	1.371	1.980	AD				
DWP-1133					2.704	2.000	0.419	1.581	1.710	AE				
DWP-1134					2.688	2.250	0.458	1.792	1.500	AE				

PRECISION SPRINGS

Wire size below .031 squared and not ground. Wire size .031 and above, squared with ground ends. Please inquire if you need a size not listed above.

STOCK PRECISION SPRINGS

316 Stainless Steel

Ends Squared and Ground
(See Below)

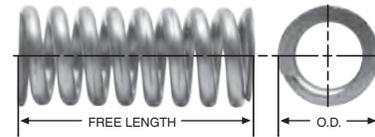

PRECISION SPRINGS

DIAMOND WIRE SPRING STOCK NO.	OUTSIDE DIAMETER	TO WORK IN HOLE DIA.	TO WORK OVER ROD DIA.	WIRE DIAMETER	APPROX. LOAD AT SOLID HT.	FREE LENGTH	SOLID HT.	TOTAL DEFLECTION	SPRING RATE	PRICE GROUP		
	IN.	IN.	IN.	IN.	LB.	IN.	IN.	IN.	LB./IN.			
DWP-1135	1.580	1.625	1.375	0.067	2.683	2.500	0.498	2.002	1.340	AE		
DWP-1136					2.656	2.750	0.537	2.213	1.200	AE		
DWP-1137					2.665	3.000	0.577	2.423	1.100	AI		
DWP-1138	1.580	1.625	1.375	0.072	5.460	1.750	0.328	1.422	3.840	AD		
DWP-1139					5.419	2.000	0.358	1.642	3.300	AE		
DWP-1140					5.381	2.250	0.388	1.862	2.890	AE		
DWP-1141					5.353	2.500	0.417	2.083	2.570	AE		
DWP-1142					5.343	2.750	0.447	2.303	2.320	AE		
DWP-1143					5.324	3.000	0.477	2.523	2.110	AI		
DWP-1144	1.580	1.625	1.375	0.080	8.247	1.750	0.364	1.386	5.950	AD		
DWP-1145					8.170	2.000	0.398	1.602	5.100	AE		
DWP-1146					8.131	2.250	0.431	1.819	4.470	AE		
DWP-1147					8.079	2.500	0.465	2.035	3.970	AE		
DWP-1148					8.059	2.750	0.499	2.251	3.580	AE		
DWP-1149					8.018	3.000	0.533	2.467	3.250	AI		
DWP-1150	1.580	1.625	1.344	0.085	11.047	1.750	0.376	1.374	8.040	AD		
DWP-1151					10.948	2.000	0.411	1.589	6.890	AE		
DWP-1152					10.884	2.250	0.445	1.805	6.030	AE		
DWP-1153					10.807	2.500	0.480	2.020	5.350	AE		
DWP-1154					10.778	2.750	0.514	2.236	4.820	AE		
DWP-1155					10.735	3.000	0.549	2.451	4.380	AI		
DWP-1156	1.580	1.625	1.344	0.092	13.931	1.750	0.422	1.328	10.490	AD		
DWP-1157					13.772	2.000	0.463	1.537	8.960	AE		
DWP-1158					13.679	2.250	0.503	1.747	7.830	AE		
DWP-1159					13.594	2.500	0.544	1.956	6.950	AE		
DWP-1160					For additional size options see page 97		13.538	2.750	0.584	2.166	6.250	AE
DWP-1161							13.466	3.000	0.625	2.375	5.670	AI

Wire size below .031 squared and not ground. Wire size .031 and above, squared with ground ends. Please inquire if you need a size not listed above.

STOCK COMPRESSION SPRINGS

Music Wire/Oil Tempered & Stainless (See Below)

Ends Squared and Ground Ends to be Square Within 3 Degrees of Axis

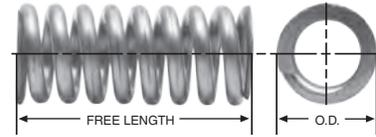

DIAMOND WIRE SPRING STOCK NO.	OUTSIDE DIAMETER	TO WORK IN HOLE DIA.	TO WORK OVER ROD DIA.	WIRE DIA.	APPROX. LOAD AT SOLID HT.	FREE LENGTH	SOLID HT.	TOTAL DEFLECTION	SPRING RATE	PRICE GROUP	
	IN.	IN.	IN.	IN.	LB.	IN.	IN.	IN.	LB./IN.	OT/MW	SS
DWC-014A-1	0.120	0.125	0.078	0.014	1.750	0.250	0.101	0.149	11.0	A	B
DWC-014A-1.5						0.313	0.105	0.208	8.9	A	B
DWC-014A-2						0.375	0.136	0.239	6.9	A	B
DWC-014A-3						0.437	0.152	0.285	5.9	A	B
DWC-014A-4						0.500	0.168	0.332	5.2	A	B
DWC-014A-4.5						0.563	0.172	0.391	4.6	A	B
DWC-014A-5						0.625	0.200	0.425	4.1	A	B
DWC-014A-5.5						0.688	0.206	0.482	3.8	A	B
DWC-014A-6						0.750	0.235	0.515	3.4	A	B
DWC-014A-6.5						0.813	0.254	0.559	3.1	A	B
DWC-014A-7						0.875	0.269	0.606	2.9	A	B
DWC-014A-7.5						0.938	0.287	0.651	2.7	A	B
DWC-014A-8						1.000	0.301	0.699	2.5	A	B
DWC-014A-8.5						1.125	0.324	0.801	2.3	A	B
DWC-014A-9	1.250	0.368	0.882	2.0	A	B					
DWC-014A-10	1.500	0.434	1.066	1.7	A	B					
DWC-016A-1	0.120	0.125	0.078	0.016	2.495	0.250	0.119	0.131	17.5	A	B
DWC-016A-1.5						0.313	0.133	0.180	14.0	A	B
DWC-016A-2						0.375	0.163	0.212	11.3	A	B
DWC-016A-3						0.437	0.187	0.250	9.5	A	B
DWC-016A-4						0.500	0.208	0.292	8.3	A	B
DWC-016A-4.5						0.563	0.225	0.338	7.5	A	B
DWC-016A-5						0.625	0.251	0.374	6.6	A	B
DWC-016A-5.5						0.688	0.273	0.415	6.0	A	B
DWC-016A-6						0.750	0.303	0.447	5.3	A	B
DWC-016A-8						1.000	0.378	0.622	4.1	A	B
DWC-016A-6.5						1.125	0.442	0.683	3.5	A	B
DWC-016A-9						1.250	0.463	0.787	3.2	A	B
DWC-016A-10						1.500	0.544	0.956	2.8	A	B
DWC-018A-1						0.120	0.125	0.078	0.018	3.334	0.250
DWC-018A-2	0.375	0.194	0.181	17.9	A						B
DWC-018A-3	0.437	0.220	0.217	15.2	A						B
DWC-018A-4	0.500	0.248	0.252	13.1	A						B
DWC-018A-4.5	0.563	0.271	0.292	11.5	A						B
DWC-018A-5	0.625	0.297	0.328	10.6	A						B
DWC-018A-5.5	0.688	0.325	0.363	9.5	A						B
DWC-018A-6	0.750	0.359	0.391	8.5	A						B
DWC-018A-7.5	0.313	0.159	0.154	22.0	A						B
DWC-018A-8	1.000	0.455	0.545	6.4	A						B
DWC-018A-8.5	1.125	0.510	0.615	5.6	A						B
DWC-018A-9	1.250	0.559	0.691	5.1	A						B
DWC-018A-10	1.500	0.663	0.837	4.2	A						B
DWC-020A-1	0.120	0.125	0.063	0.020	4.404						0.250
DWC-020A-1.5						0.313	0.185	0.128	36.0	A	B
DWC-020A-2						0.375	0.226	0.149	27.7	A	B
DWC-020A-3						0.437	0.256	0.181	23.5	A	B
DWC-020A-4						0.500	0.285	0.215	20.4	A	B

Note: Wire Dia. up to .098" is Music Wire (MW); .105" and over is Oil Tempered Wire (OT). Stainless available up to .135" wire size. Above rates and loads are multiplied by .833 when using stainless. For prices from 1 to 100 see Price Index. Please inquire if you need a size not listed above.

STOCK COMPRESSION SPRINGS

Music Wire/Oil Tempered & Stainless (See Below)

Ends Squared and Ground Ends to be Square Within 3 Degrees of Axis

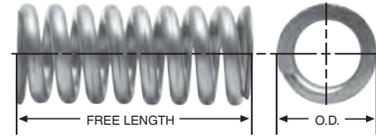

COMPRESSION SPRINGS

DIAMOND WIRE SPRING STOCK NO.	OUTSIDE DIAMETER	TO WORK IN HOLE DIA.	TO WORK OVER ROD DIA.	WIRE DIA.	APPROX. LOAD AT SOLID HT.	FREE LENGTH	SOLID HT.	TOTAL DEFLECTION	SPRING RATE	PRICE GROUP	
	IN.	IN.	IN.	IN.	LB.	IN.	IN.	IN.	LB./IN.	OT/MW	SS
DWC-020A-4.5	0.120	0.125	0.063	0.020	4.404	0.563	0.310	0.253	18.5	A	B
DWC-020A-5						0.625	0.344	0.281	16.2	A	B
DWC-020A-5.5						0.688	0.375	0.313	15.0	A	B
DWC-020A-6						0.750	0.407	0.343	13.2	A	B
DWC-020A6.5						0.813	0.430	0.383	12.5	A	B
DWC-020A-7						0.875	0.471	0.404	11.2	A	B
DWC-020A-7.5						0.938	0.510	0.428	10.8	A	B
DWC-020A-8						1.000	0.530	0.470	9.8	A	B
DWC-020A-8.5						1.125	0.600	0.525	9.0	A	B
DWC-020A-9						1.250	0.652	0.598	7.8	A	B
DWC-020A-10	1.500	0.774	0.726	6.4	A	B					
DWC-022A-1	0.120	0.125	0.063	0.022	5.856	0.250	0.171	0.079	70.6	A	B
DWC-022A-1.5						0.313	0.199	0.114	54.0	A	B
DWC-022A-2						0.375	0.252	0.123	41.5	A	B
DWC-022A-3						0.437	0.280	0.157	36.4	A	B
DWC-022A-4						0.500	0.319	0.181	31.1	A	B
DWC-022A-4.5						0.563	0.342	0.221	28.0	A	B
DWC-022A-5						0.625	0.384	0.241	24.9	A	B
DWC-022A-5.5						0.688	0.419	0.269	22.0	A	B
DWC-022A-6						0.750	0.461	0.289	20.2	A	B
DWC-022A-6.5						0.813	0.495	0.318	18.0	A	B
DWC-022A-7.5	0.938	0.555	0.383	16.0	A	B					
DWC-022A-8	1.000	0.600	0.400	14.7	A	B					
DWC-022A-8.5	1.125	0.665	0.460	13.0	A	B					
DWC-022A-9	1.250	0.739	0.511	11.7	A	B					
DWC-022A-10	1.500	0.879	0.621	9.7	A	B					
DWC-024A-1	0.120	0.125	0.066	0.024	7.729	0.250	0.179	0.071	107.4	A	B
DWC-024A-1.5						0.312	0.219	0.093	82.2	A	B
DWC-024A-2						0.375	0.259	0.116	66.4	A	B
DWC-024A-4						0.500	0.339	0.161	48.0	A	B
DWC-024A-4.5						0.562	0.379	0.183	42.2	A	B
DWC-024A-5						0.625	0.419	0.206	37.6	A	B
DWC-024A-5.5						0.687	0.459	0.228	33.9	A	B
DWC-024A-6						0.750	0.499	0.251	30.9	A	B
DWC-024A-6.5						0.812	0.539	0.273	28.4	A	B
DWC-024A-7						0.875	0.580	0.295	26.2	A	B
DWC-024A-7.5	0.937	0.619	0.318	24.4	A	B					
DWC-024A-8	1.000	0.659	0.341	22.8	A	B					
DWC-024A-8.5	1.125	0.740	0.385	20.2	A	B					
DWC-024A-9	1.250	0.820	0.430	18.0	A	B					
DWC-024A-10	1.500	0.980	0.520	14.9	A	B					
DWC-014AA-1	0.125	0.140	0.089	0.014	1.557	0.250	0.091	0.159	9.8	A	B
DWC-014AA-1.5						0.313	0.108	0.205	7.6	A	B
DWC-014AA-2						0.375	0.126	0.249	6.2	A	B
DWC-014AA-3						0.438	0.143	0.295	5.3	A	B
DWC-014AA-4						0.500	0.161	0.339	4.6	A	B
DWC-014AA-4.5						0.563	0.178	0.385	4.1	A	B

Note: Wire Dia. up to .098" is Music Wire (MW); .105" and over is Oil Tempered Wire (OT). Stainless available up to .135" wire size. Above rates and loads are multiplied by .833 when using stainless. For prices from 1 to 100 see Price Index. Please inquire if you need a size not listed above.

STOCK COMPRESSION SPRINGS

Music Wire/Oil Tempered & Stainless (See Below)

Ends Squared and Ground Ends to be Square Within 3 Degrees of Axis

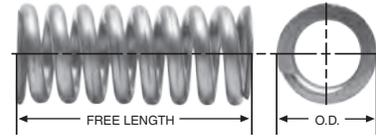

DIAMOND WIRE SPRING STOCK NO.	OUTSIDE DIAMETER	TO WORK IN HOLE DIA.	TO WORK OVER ROD DIA.	WIRE DIA.	APPROX. LOAD AT SOLID HT.	FREE LENGTH	SOLID HT.	TOTAL DEFLECTION	SPRING RATE	PRICE GROUP	
	IN.	IN.	IN.	IN.	LB.	IN.	IN.	IN.	LB./IN.	OT/MW	SS
DWC-014AA-5	0.125	0.140	0.089	0.014	1.557	0.625	0.196	0.429	3.6	A	B
DWC-014AA-5.5						0.688	0.213	0.475	3.3	A	B
DWC-014AA-6						0.750	0.231	0.519	3.0	A	B
DWC-014AA-6.5						0.813	0.248	0.565	2.8	A	B
DWC-014AA-7						0.875	0.266	0.609	2.6	A	B
DWC-014AA-7.5						0.938	0.283	0.655	2.4	A	B
DWC-014AA-8						1.000	0.301	0.699	2.2	A	B
DWC-014AA-8.5						1.125	0.336	0.789	2.0	A	B
DWC-014AA-9						1.250	0.371	0.879	1.8	A	B
DWC-014AA-9.5						1.375	0.406	0.969	1.6	A	B
DWC-014AA-10	1.500	0.441	1.059	1.5	A	B					
DWC-016AA-1	0.125	0.140	0.085	0.016	2.728	0.250	0.101	0.149	18.3	A	B
DWC-016AA-1.5						0.313	0.121	0.192	14.2	A	B
DWC-016AA-2						0.375	0.140	0.235	11.6	A	B
DWC-016AA-3						0.438	0.160	0.278	9.8	A	B
DWC-016AA-4						0.500	0.179	0.321	8.5	A	B
DWC-016AA-4.5						0.563	0.199	0.364	7.5	A	B
DWC-016AA-5						0.625	0.219	0.406	6.7	A	B
DWC-016AA-5.5						0.688	0.238	0.450	6.1	A	B
DWC-016AA-6						0.750	0.258	0.492	5.6	A	B
DWC-016AA-6.5						0.813	0.277	0.536	5.1	A	B
DWC-016AA-7.5						0.938	0.317	0.621	4.4	A	B
DWC-016AA-8						1.000	0.336	0.664	4.1	A	B
DWC-016AA-9						1.250	0.415	0.835	3.3	A	B
DWC-016AA-10	1.500	0.493	1.007	2.7	A	B					
DWC-018AA-1	0.125	0.140	0.082	0.018	3.841	0.250	0.120	0.130	28.5	A	B
DWC-018AA-1.5						0.313	0.145	0.168	22.0	A	B
DWC-018AA-2						0.375	0.169	0.206	18.0	A	B
DWC-018AA-4						0.500	0.218	0.282	13.1	A	B
DWC-018AA-4.5						0.563	0.243	0.320	11.6	A	B
DWC-018AA-5						0.625	0.267	0.358	10.3	A	B
DWC-018AA-5.5						0.688	0.292	0.396	9.3	A	B
DWC-018AA-6						0.750	0.316	0.434	8.5	A	B
DWC-018AA-6.5						0.813	0.340	0.473	7.8	A	B
DWC-018AA7.5						0.938	0.389	0.549	6.8	A	B
DWC-018AA-8						1.000	0.414	0.586	6.3	A	B
DWC-018AA-9						1.250	0.511	0.739	5.0	A	B
DWC-018AA-10						1.500	0.609	0.891	4.2	A	B
DWC-020AA-1	0.125	0.140	0.078	0.020	5.427	0.250	0.131	0.119	47.4	A	B
DWC-020AA-1.5						0.313	0.158	0.155	36.5	A	B
DWC-020AA-2						0.375	0.184	0.191	31.0	A	B
DWC-020AA-4						0.500	0.240	0.260	21.5	A	B
DWC-020AA-4.5						0.563	0.269	0.294	18.7	A	B
DWC-020AA-5						0.625	0.298	0.327	16.6	A	B
DWC-020AA-5.5						0.688	0.328	0.360	14.9	A	B
DWC-020AA-6						0.750	0.358	0.392	13.5	A	B
DWC-020AA-6.5						0.813	0.386	0.427	12.4	A	B

Note: Wire Dia. up to .098" is Music Wire (MW); .105" and over is Oil Tempered Wire (OT). Stainless available up to .135" wire size. Above rates and loads are multiplied by .833 when using stainless. For prices from 1 to 100 see Price Index. Please inquire if you need a size not listed above.

STOCK COMPRESSION SPRINGS

Music Wire/Oil Tempered & Stainless (See Below)

Ends Squared and Ground Ends to be Square Within 3 Degrees of Axis

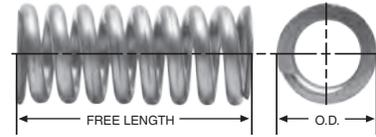

COMPRESSION SPRINGS

DIAMOND WIRE SPRING STOCK NO.	OUTSIDE DIAMETER	TO WORK IN HOLE DIA.	TO WORK OVER ROD DIA.	WIRE DIA.	APPROX. LOAD AT SOLID HT.	FREE LENGTH	SOLID HT.	TOTAL DEFLECTION	SPRING RATE	PRICE GROUP	
	IN.	IN.	IN.	IN.	LB.	IN.	IN.	IN.	LB./IN.	OT/MW	SS
DWC-020AA7.5	0.125	0.140	0.078	0.020	5.427	0.938	0.442	0.496	10.6	A	B
DWC-020AA-8						1.000	0.469	0.531	10.0	A	B
DWC-020AA-9						1.250	0.581	0.669	7.9	A	B
DWC-020AA-10						1.500	0.693	0.807	6.5	A	B
DWC-022AA-1	0.125	0.140	0.074	0.022	6.944	0.250	0.150	0.100	69.1	A	B
DWC-022AA-1.5						0.313	0.183	0.130	52.9	A	B
DWC-022AA-2						0.375	0.214	0.161	43.0	A	B
DWC-022AA-4						0.500	0.278	0.222	31.2	A	B
DWC-022AA-4.5						0.563	0.311	0.252	27.4	A	B
DWC-022AA-5						0.625	0.342	0.283	24.5	A	B
DWC-022AA-5.5						0.688	0.375	0.313	22.1	A	B
DWC-022AA-6.5						0.813	0.439	0.374	18.5	A	B
DWC-022AA7.5						0.938	0.503	0.435	15.9	A	B
DWC-022AA-8						1.000	0.531	0.469	15.0	A	B
DWC-022AA-9						1.250	0.658	0.592	11.9	A	B
DWC-022AA-10	1.500	0.785	0.715	9.8	A	B					
DWC-016AB-1	0.148	0.156	0.110	0.016	1.878	0.250	0.092	0.158	11.9	A	B
DWC-016AB-1.5						0.313	0.109	0.204	9.2	A	B
DWC-016AB-2						0.375	0.126	0.249	7.5	A	B
DWC-016AB-3						0.438	0.144	0.294	6.4	A	B
DWC-016AB-4						0.500	0.161	0.339	5.5	A	B
DWC-016AB-4.5						0.563	0.178	0.385	4.9	A	B
DWC-016AB-5						0.625	0.195	0.430	4.4	A	B
DWC-016AB-5.5						0.688	0.212	0.476	3.9	A	B
DWC-016AB-6						0.750	0.229	0.521	3.6	A	B
DWC-016AB-6.5						0.813	0.246	0.567	3.3	A	B
DWC-016AB-7.5						0.938	0.280	0.658	2.9	A	B
DWC-016AB-8	1.000	0.297	0.703	2.7	A	B					
DWC-016AB-9	1.250	0.365	0.885	2.1	A	B					
DWC-016AB-10	1.500	0.433	1.067	1.8	A	B					
DWC-018AB-1	0.148	0.156	0.106	0.018	2.856	0.250	0.105	0.145	19.6	A	B
DWC-018AB-1.5						0.313	0.125	0.188	15.2	A	B
DWC-018AB-2						0.375	0.145	0.230	12.4	A	B
DWC-018AB-3						0.438	0.164	0.274	10.4	A	B
DWC-018AB-4						0.500	0.184	0.316	9.0	A	B
DWC-018AB-4.5						0.563	0.204	0.359	8.0	A	B
DWC-018AB-5						0.625	0.224	0.401	7.1	A	B
DWC-018AB-5.5						0.688	0.244	0.444	6.4	A	B
DWC-018AB-6						0.750	0.264	0.486	5.9	A	B
DWC-018AB-6.5						0.813	0.283	0.530	5.4	A	B
DWC-018AB-7.5						0.938	0.323	0.615	4.6	A	B
DWC-018AB-8	1.000	0.343	0.657	4.3	A	B					
DWC-018AB-9	1.250	0.422	0.828	3.5	A	B					
DWC-018AB-10	1.500	0.501	0.999	2.9	A	B					
DWC-021AB-1	0.148	0.156	0.093	0.021	3.745	0.250	0.132	0.118	31.7	A	B
DWC-021AB-1.5						0.313	0.160	0.153	25.0	A	B
DWC-021AB-2						0.375	0.187	0.188	19.8	A	B

Note: Wire Dia. up to .098" is Music Wire (MW); .105" and over is Oil Tempered Wire (OT). Stainless available up to .135" wire size. Above rates and loads are multiplied by .833 when using stainless. For prices from 1 to 100 see Price Index. Please inquire if you need a size not listed above.

STOCK COMPRESSION SPRINGS

Music Wire/Oil Tempered & Stainless (See Below)

Ends Squared and Ground Ends to be Square Within 3 Degrees of Axis

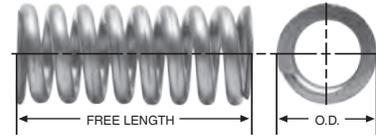

DIAMOND WIRE SPRING STOCK NO.	OUTSIDE DIAMETER	TO WORK IN HOLE DIA.	TO WORK OVER ROD DIA.	WIRE DIA.	APPROX. LOAD AT SOLID HT.	FREE LENGTH	SOLID HT.	TOTAL DEFLECTION	SPRING RATE	PRICE GROUP	
	IN.	IN.	IN.	IN.	LB.	IN.	IN.	IN.	LB./IN.	OT/MW	SS
DWC-021AB-3	0.148	0.156	0.093	0.021	3.745	0.437	0.212	0.225	16.8	A	B
DWC-021AB-4						0.500	0.242	0.258	14.4	A	B
DWC-021AB-4.5						0.563	0.268	0.295	13.0	A	B
DWC-021AB-5						0.625	0.294	0.331	11.4	A	B
DWC-021AB-5.5						0.688	0.321	0.367	10.5	A	B
DWC-021AB-6						0.750	0.349	0.401	9.5	A	B
DWC-021AB-6.5						0.813	0.376	0.437	8.9	A	B
DWC-021AB-7.5						0.938	0.430	0.508	7.5	A	B
DWC-021AB-8						1.000	0.458	0.542	6.9	A	B
DWC-021AB-9						1.250	0.568	0.682	5.5	A	B
DWC-021AB-10						1.500	0.675	0.825	4.8	A	B
DWC-021AB-11						1.750	0.796	0.954	3.8	A	B
DWC-021AB-12	2.000	0.885	1.115	3.4	A	B					
DWC-023AB-1	0.148	0.156	0.093	0.023	4.977	0.250	0.147	0.103	47.5	A	B
DWC-023AB-1.5						0.313	0.178	0.135	36.5	A	B
DWC-023AB-2						0.375	0.209	0.166	29.2	A	B
DWC-023AB-3						0.437	0.239	0.198	25.1	A	B
DWC-023AB-4						0.500	0.272	0.228	21.8	A	B
DWC-023AB-4.5						0.563	0.302	0.261	19.0	A	B
DWC-023AB-5						0.625	0.334	0.291	16.7	A	B
DWC-023AB-5.5						0.688	0.364	0.324	15.5	A	B
DWC-023AB-6						0.750	0.396	0.354	13.8	A	B
DWC-023AB-6.5						0.813	0.425	0.388	12.8	A	B
DWC-023AB-7.5						0.938	0.505	0.433	11.0	A	B
DWC-023AB-8						1.000	0.518	0.482	10.0	A	B
DWC-023AB-9	1.250	0.652	0.598	8.0	A	B					
DWC-023AB-10	1.500	0.773	0.727	6.6	A	B					
DWC-023AB-11	1.750	0.887	0.863	5.6	A	B					
DWC-023AB-12	2.000	1.010	0.990	4.9	A	B					
DWC-026AB-1	0.148	0.156	0.078	0.026	6.500	0.250	0.169	0.081	80.4	A	B
DWC-026AB-2						0.375	0.243	0.132	49.3	A	B
DWC-026AB-3						0.437	0.280	0.157	41.3	A	B
DWC-026AB-4						0.500	0.317	0.183	35.5	A	B
DWC-026AB-5						0.625	0.391	0.234	27.8	A	B
DWC-026AB-6						0.750	0.464	0.286	22.8	A	B
DWC-026AB-8						1.000	0.612	0.388	16.8	A	B
DWC-026AB-9						1.250	0.760	0.490	13.3	A	B
DWC-026AB-10						1.500	0.908	0.592	11.0	A	B
DWC-026AB-11						1.750	1.056	0.694	9.4	A	B
DWC-026AB-12						2.000	1.204	0.796	8.2	A	B
DWC-029AB-1						0.148	0.156	0.078	0.029	8.800	0.250
DWC-029AB-2	0.375	0.269	0.106	83.0	A						B
DWC-029AB-3	0.437	0.310	0.127	69.4	A						B
DWC-029AB-4	0.500	0.352	0.148	59.5	A						B
DWC-029AB-5	0.625	0.435	0.190	46.4	A						B
DWC-029AB-6	0.750	0.518	0.232	38.0	A						B
DWC-029AB-8	1.000	0.685	0.315	27.9	A						B

Note: Wire Dia. up to .098" is Music Wire (MW); .105" and over is Oil Tempered Wire (OT). Stainless available up to .135" wire size. Above rates and loads are multiplied by .833 when using stainless. For prices from 1 to 100 see Price Index. Please inquire if you need a size not listed above.

STOCK COMPRESSION SPRINGS

Music Wire/Oil Tempered & Stainless (See Below)

Ends Squared and Ground Ends to be Square Within 3 Degrees of Axis

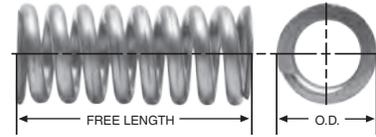

COMPRESSION SPRINGS

DIAMOND WIRE SPRING STOCK NO.	OUTSIDE DIAMETER	TO WORK IN HOLE DIA.	TO WORK OVER ROD DIA.	WIRE DIA.	APPROX. LOAD AT SOLID HT.	FREE LENGTH	SOLID HT.	TOTAL DEFLECTION	SPRING RATE	PRICE GROUP	
	IN.	IN.	IN.	IN.	LB.	IN.	IN.	IN.	LB./IN.	OT/MW	SS
DWC-029AB-9	0.148	0.156	0.078	0.029	8.800	1.250	0.851	0.399	22.0	A	B
DWC-029AB-10						1.500	1.017	0.483	18.2	A	B
DWC-029AB-11						1.750	1.183	0.567	15.6	A	B
DWC-029AB-12						2.000	1.350	0.650	13.6	A	B
DWC-016AC-1	0.156	0.171	0.116	0.016	1.764	0.250	0.087	0.163	10.8	A	B
DWC-016AC-1.5						0.313	0.102	0.211	8.4	A	B
DWC-016AC-2						0.375	0.118	0.257	6.9	A	B
DWC-016AC-3						0.438	0.134	0.304	5.8	A	B
DWC-016AC-4						0.500	0.149	0.351	5.0	A	B
DWC-016AC-4.5						0.563	0.165	0.398	4.4	A	B
DWC-016AC-5						0.625	0.180	0.445	4.0	A	B
DWC-016AC-5.5						0.688	0.196	0.492	3.6	A	B
DWC-016AC-6						0.750	0.211	0.539	3.3	A	B
DWC-016AC-8						1.000	0.273	0.727	2.5	A	B
DWC-016AC-8.5						1.125	0.305	0.820	2.2	A	B
DWC-016AC-9						1.250	0.336	0.914	1.9	A	B
DWC-016AC-10	1.500	0.398	1.102	1.6	A	B					
DWC-023AC-1	0.156	0.171	0.103	0.023	5.571	0.250	0.135	0.115	48.1	A	B
DWC-023AC-1.5						0.313	0.162	0.151	36.8	A	B
DWC-023AC-2						0.375	0.189	0.186	29.8	A	B
DWC-023AC-3						0.438	0.216	0.222	25.0	A	B
DWC-023AC-4						0.500	0.242	0.258	21.6	A	B
DWC-023AC-4.5						0.563	0.269	0.294	19.0	A	B
DWC-023AC-5						0.625	0.296	0.329	17.0	A	B
DWC-023AC-5.5						0.688	0.323	0.365	15.3	A	B
DWC-023AC-6						0.750	0.350	0.400	13.9	A	B
DWC-023AC-6.5						0.813	0.377	0.436	12.8	A	B
DWC-023AC-7.5						0.938	0.431	0.507	11.0	A	B
DWC-023AC-8						1.000	0.458	0.542	10.3	A	B
DWC-023AC-9	1.250	0.565	0.685	8.2	A	B					
DWC-023AC-10	1.500	0.673	0.827	6.8	A	B					
DWC-014B-1	0.180	0.187	0.140	0.014	1.122	0.250	0.069	0.181	6.2	A	B
DWC-014B-1.5						0.313	0.077	0.236	4.5	A	B
DWC-014B-2						0.375	0.085	0.290	3.9	A	B
DWC-014B-3						0.437	0.092	0.345	3.4	A	B
DWC-014B-4						0.500	0.100	0.400	2.9	A	B
DWC-014B-4.5						0.563	0.112	0.451	2.4	A	B
DWC-014B-5						0.625	0.114	0.511	2.3	A	B
DWC-014B-5.5						0.688	0.129	0.559	2.0	A	B
DWC-014B-6						0.750	0.130	0.620	1.9	A	B
DWC-014B-7						0.875	0.146	0.729	1.6	A	B
DWC-014B-8						1.000	0.161	0.839	1.4	A	B
DWC-014B-9						1.250	0.191	1.059	1.1	A	B
DWC-014B-9.5	1.375	0.223	1.152	1.0	A	B					
DWC-014B-10	1.500	0.222	1.278	0.9	A	B					
DWC-016B-1	0.180	0.187	0.140	0.016	1.522	0.250	0.080	0.170	8.9	A	B
DWC-016B-1.5						0.313	0.081	0.232	7.5	A	B

Note: Wire Dia. up to .098" is Music Wire (MW); .105" and over is Oil Tempered Wire (OT). Stainless available up to .135" wire size. Above rates and loads are multiplied by .833 when using stainless. For prices from 1 to 100 see Price Index. Please inquire if you need a size not listed above.

STOCK COMPRESSION SPRINGS

Music Wire/Oil Tempered & Stainless (See Below)

Ends Squared and Ground Ends to be Square Within 3 Degrees of Axis

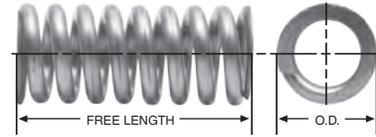

DIAMOND WIRE SPRING STOCK NO.	OUTSIDE DIAMETER	TO WORK IN HOLE DIA.	TO WORK OVER ROD DIA.	WIRE DIA.	APPROX. LOAD AT SOLID HT.	FREE LENGTH	SOLID HT.	TOTAL DEFLECTION	SPRING RATE	PRICE GROUP	
	IN.	IN.	IN.	IN.	LB.	IN.	IN.	IN.	LB./IN.	OT/MW	SS
DWC-016B-2	0.180	0.187	0.140	0.016	1.522	0.375	0.100	0.275	5.9	A	B
DWC-016B-3						0.437	0.112	0.325	4.9	A	B
DWC-016B-4						0.500	0.124	0.376	4.2	A	B
DWC-016B-4.5						0.563	0.125	0.438	4.0	A	B
DWC-016B-5						0.625	0.144	0.481	3.4	A	B
DWC-016B-5.5						0.688	0.153	0.535	3.0	A	B
DWC-016B-6						0.750	0.167	0.583	2.8	A	B
DWC-016B-7						0.875	0.185	0.690	2.5	A	B
DWC-016B-8						1.000	0.204	0.796	2.2	A	B
DWC-016B-9						1.250	0.245	1.005	1.7	A	B
DWC-016B-9.5						1.375	0.305	1.070	1.3	A	B
DWC-016B-10	1.500	0.285	1.215	1.4	A	B					
DWC-016B-11	1.750	0.405	1.345	1.0	A	B					
DWC-018B-1	0.180	0.187	0.140	0.018	2.363	0.250	0.094	0.156	13.5	A	B
DWC-018B-1.5						0.313	0.100	0.213	11.0	A	B
DWC-018B-2						0.375	0.116	0.259	9.3	A	B
DWC-018B-3						0.437	0.130	0.307	7.8	A	B
DWC-018B-4						0.500	0.144	0.356	6.7	A	B
DWC-018B-4.5						0.563	0.150	0.413	6.0	A	B
DWC-018B-5						0.625	0.175	0.450	5.1	A	B
DWC-018B-5.5						0.688	0.186	0.502	4.5	A	B
DWC-018B-6						0.750	0.207	0.543	4.1	A	B
DWC-018B-7						0.875	0.227	0.648	3.7	A	B
DWC-018B-8						1.000	0.252	0.748	3.2	A	B
DWC-018B-9	1.250	0.303	0.947	2.6	A	B					
DWC-018B-9.5	1.375	0.338	1.037	2.3	A	B					
DWC-018B-10	1.500	0.355	1.145	2.1	A	B					
DWC-018B-11	1.750	0.442	1.308	1.7	A	B					
DWC-020B-1	0.180	0.187	0.125	0.020	3.083	0.250	0.113	0.137	21.2	A	B
DWC-020B-1.5						0.313	0.125	0.188	16.0	A	B
DWC-020B-2						0.375	0.146	0.229	13.1	A	B
DWC-020B-3						0.437	0.161	0.276	11.1	A	B
DWC-020B-4						0.500	0.176	0.324	9.7	A	B
DWC-020B-4.5						0.563	0.196	0.367	8.3	A	B
DWC-020B-5						0.625	0.207	0.418	7.7	A	B
DWC-020B-5.5						0.688	0.234	0.454	6.5	A	B
DWC-020B-6						0.750	0.239	0.511	6.3	A	B
DWC-020B-7						0.875	0.272	0.603	5.3	A	B
DWC-020B-8						1.000	0.302	0.698	4.6	A	B
DWC-020B-9	1.250	0.366	0.884	3.7	A	B					
DWC-020B-9.5	1.375	0.420	0.955	3.2	A	B					
DWC-020B-10	1.500	0.429	1.071	3.0	A	B					
DWC-020B-11	1.750	0.530	1.220	2.4	A	B					
DWC-022B-1	0.180	0.187	0.125	0.022	4.044	0.250	0.121	0.129	29.6	A	B
DWC-022B-1.5						0.313	0.128	0.185	24.0	A	B
DWC-022B-2						0.375	0.154	0.221	19.8	A	B

COMPRESSION SPRINGS

Note: Wire Dia. up to .098" is Music Wire (MW); .105" and over is Oil Tempered Wire (OT). Stainless available up to .135" wire size. Above rates and loads are multiplied by .833 when using stainless. For prices from 1 to 100 see Price Index. Please inquire if you need a size not listed above.

STOCK COMPRESSION SPRINGS

Music Wire/Oil Tempered & Stainless (See Below)

Ends Squared and Ground Ends to be Square Within 3 Degrees of Axis

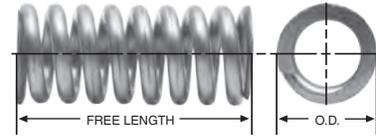

COMPRESSION SPRINGS

DIAMOND WIRE SPRING STOCK NO.	OUTSIDE DIAMETER	TO WORK IN HOLE DIA.	TO WORK OVER ROD DIA.	WIRE DIA.	APPROX. LOAD AT SOLID HT.	FREE LENGTH	SOLID HT.	TOTAL DEFLECTION	SPRING RATE	PRICE GROUP	
	IN.	IN.	IN.	IN.	LB.	IN.	IN.	IN.	LB./IN.	OT/MW	SS
DWC-022B-3	0.180	0.187	0.125	0.022	4.044	0.437	0.170	0.267	16.9	A	B
DWC-022B-4						0.500	0.192	0.308	14.2	A	B
DWC-022B-4.5						0.563	0.210	0.353	12.0	A	B
DWC-022B-5						0.625	0.241	0.384	10.5	A	B
DWC-022B-5.5						0.688	0.260	0.428	9.5	A	B
DWC-022B-6						0.750	0.280	0.470	8.7	A	B
DWC-022B-6.5						0.813	0.310	0.503	7.5	A	B
DWC-022B-7.5						0.938	0.346	0.592	6.7	A	B
DWC-022B-8						1.000	0.355	0.645	6.5	A	B
DWC-022B-8.5						1.125	0.403	0.722	5.5	A	B
DWC-022B-9						1.250	0.430	0.820	5.2	A	B
DWC-022B-10	1.500	0.506	0.994	4.3	A	B					
DWC-022B-11	1.750	0.620	1.130	3.5	A	B					
DWC-024B-1	0.180	0.187	0.125	0.024	5.076	0.250	0.143	0.107	42.3	A	B
DWC-024B-1.5						0.313	0.158	0.155	33.0	A	B
DWC-024B-2						0.375	0.189	0.186	25.7	A	B
DWC-024B-3						0.437	0.210	0.227	21.8	A	B
DWC-024B-4						0.500	0.232	0.268	18.9	A	B
DWC-024B-4.5						0.563	0.248	0.315	16.5	A	B
DWC-024B-5						0.625	0.274	0.351	14.9	A	B
DWC-024B-6						0.750	0.320	0.430	12.2	A	B
DWC-024B-7						0.875	0.366	0.509	10.3	A	B
DWC-024B-8						1.000	0.408	0.592	9.0	A	B
DWC-024B-8.5						1.125	0.466	0.659	7.8	A	B
DWC-024B-9						1.250	0.496	0.754	7.1	A	B
DWC-024B-10	1.500	0.585	0.915	5.9	A	B					
DWC-024B-11	1.750	0.672	1.078	5.0	A	B					
DWC-024B-12	2.000	0.769	1.231	4.3	A	B					
DWC-026B-1	0.180	0.187	0.109	0.026	6.497	0.250	0.149	0.101	57.8	A	B
DWC-026B-1.5						0.313	0.157	0.156	47.0	A	B
DWC-026B-2						0.375	0.195	0.180	37.5	A	B
DWC-026B-3						0.437	0.221	0.216	31.2	A	B
DWC-026B-4						0.500	0.247	0.253	26.8	A	B
DWC-026B-4.5						0.563	0.274	0.289	23.0	A	B
DWC-026B-5						0.625	0.298	0.327	20.9	A	B
DWC-026B-5.5						0.688	0.313	0.375	19.0	A	B
DWC-026B-6						0.750	0.352	0.398	17.0	A	B
DWC-026B-6.5						0.813	0.365	0.448	16.0	A	B
DWC-026B-7						0.875	0.403	0.472	14.4	A	B
DWC-026B-8						1.000	0.461	0.539	12.2	A	B
DWC-026B-8.5						1.125	0.512	0.613	10.8	A	B
DWC-026B-9	1.250	0.562	0.688	9.7	A	B					
DWC-026B-10	1.500	0.663	0.837	8.0	A	B					
DWC-026B-11	1.750	0.766	0.984	6.9	A	B					
DWC-026B-12	2.000	0.871	1.129	6.0	A	B					
DWC-029B-1	0.180	0.187	0.109	0.029	8.650	0.250	0.172	0.078	93.1	A	B
DWC-029B-1.5						0.313	0.187	0.126	76.0	A	B

Note: Wire Dia. up to .098" is Music Wire (MW); .105" and over is Oil Tempered Wire (OT). Stainless available up to .135" wire size. Above rates and loads are multiplied by .833 when using stainless. For prices from 1 to 100 see Price Index. Please inquire if you need a size not listed above.

STOCK COMPRESSION SPRINGS

Music Wire/Oil Tempered & Stainless (See Below)

Ends Squared and Ground Ends to be Square Within 3 Degrees of Axis

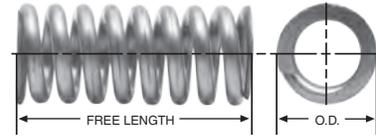

DIAMOND WIRE SPRING STOCK NO.	OUTSIDE DIAMETER	TO WORK IN HOLE DIA.	TO WORK OVER ROD DIA.	WIRE DIA.	APPROX. LOAD AT SOLID HT.	FREE LENGTH	SOLID HT.	TOTAL DEFLECTION	SPRING RATE	PRICE GROUP	
	IN.	IN.	IN.	IN.	LB.	IN.	IN.	IN.	LB./IN.	OT/MW	SS
DWC-029B-2	0.180	0.187	0.109	0.029	8.650	0.375	0.241	0.134	55.5	A	B
DWC-029B-3						0.437	0.270	0.167	46.8	A	B
DWC-029B-4						0.500	0.299	0.201	40.5	A	B
DWC-029B-4.5						0.563	0.315	0.248	37.5	A	B
DWC-029B-5						0.625	0.356	0.269	31.8	A	B
DWC-029B-5.5						0.688	0.372	0.316	30.0	A	B
DWC-029B-6						0.750	0.418	0.332	25.8	A	B
DWC-029B-6.5						0.813	0.437	0.376	25.0	A	B
DWC-029B-7						0.875	0.481	0.394	21.8	A	B
DWC-029B-7.5						0.938	0.502	0.436	21.3	A	B
DWC-029B-8						1.000	0.538	0.462	19.0	A	B
DWC-029B-8.5						1.125	0.590	0.535	17.5	A	B
DWC-029B-9						1.250	0.658	0.592	15.0	A	B
DWC-029B-9.5						1.375	0.715	0.660	14.0	A	B
DWC-029B-10	1.500	0.778	0.722	12.4	A	B					
DWC-029B-11	1.750	0.885	0.865	10.8	A	B					
DWC-029B-12	2.000	1.015	0.985	9.5	A	B					
DWC-032B-1.5	0.180	0.188	0.110	0.032	12.633	0.313	0.193	0.120	122.0	A	B
DWC-032B-2						0.375	0.240	0.135	97.0	A	B
DWC-032B-3						0.437	0.280	0.157	77.5	A	B
DWC-032B-4						0.500	0.319	0.181	64.9	A	B
DWC-032B-4.5						0.563	0.337	0.226	58.0	A	B
DWC-032B-5						0.625	0.382	0.243	51.3	A	B
DWC-032B-5.5						0.688	0.393	0.295	47.0	A	B
DWC-032B-6						0.750	0.456	0.294	41.3	A	B
DWC-032B-6.5						0.813	0.481	0.332	37.0	A	B
DWC-032B-7						0.875	0.543	0.332	33.5	A	B
DWC-032B-7.5						0.938	0.561	0.377	32.0	A	B
DWC-032B-8						1.000	0.608	0.392	29.4	A	B
DWC-032B-8.5						1.125	0.655	0.470	26.0	B	C
DWC-032B-9						1.250	0.748	0.502	22.8	B	C
DWC-032B-9.5	1.375	0.789	0.586	21.0	B	C					
DWC-032B-10	1.500	0.885	0.615	18.8	B	C					
DWC-032B-11	1.750	0.994	0.756	16.5	B	C					
DWC-032B-12	2.000	1.160	0.840	14.2	B	C					
DWC-035B-2	0.180	0.188	0.104	0.035	15.714	0.375	0.263	0.112	139.2	A	B
DWC-035B-3						0.438	0.303	0.135	115.3	A	B
DWC-035B-4						0.500	0.342	0.158	98.7	A	B
DWC-035B-4.5						0.563	0.381	0.182	86.1	A	B
DWC-035B-5						0.625	0.420	0.205	76.5	A	B
DWC-035B-5.5						0.688	0.460	0.228	68.7	A	B
DWC-035B-6						0.750	0.498	0.252	62.4	A	B
DWC-035B-6.5						0.813	0.538	0.275	57.1	B	C
DWC-035B-7						0.875	0.577	0.298	52.7	B	C
DWC-035B-7.5						0.938	0.616	0.322	48.9	B	C
DWC-035B-8						1.000	0.655	0.345	45.7	B	C
DWC-035B-8.5						1.125	0.734	0.391	40.2	B	C

COMPRESSION SPRINGS

Note: Wire Dia. up to .098" is Music Wire (MW); .105" and over is Oil Tempered Wire (OT). Stainless available up to .135" wire size. Above rates and loads are multiplied by .833 when using stainless. For prices from 1 to 100 see Price Index. Please inquire if you need a size not listed above.

STOCK COMPRESSION SPRINGS

Music Wire/Oil Tempered & Stainless (See Below)

Ends Squared and Ground Ends to be Square Within 3 Degrees of Axis

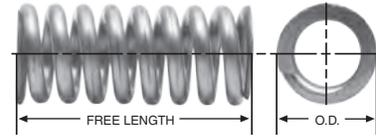

COMPRESSION SPRINGS

DIAMOND WIRE SPRING STOCK NO.	OUTSIDE DIAMETER	TO WORK IN HOLE DIA.	TO WORK OVER ROD DIA.	WIRE DIA.	APPROX. LOAD AT SOLID HT.	FREE LENGTH	SOLID HT.	TOTAL DEFLECTION	SPRING RATE	PRICE GROUP	
	IN.	IN.	IN.	IN.	LB.	IN.	IN.	IN.	LB./IN.	OT/MW	SS
DWC-035B-9	0.180	0.188	0.104	0.035	15.714	1.250	0.812	0.438	36.0	B	C
DWC-035B-9.5						1.375	0.890	0.485	32.5	B	C
DWC-035B-10						1.500	0.969	0.531	29.7	B	C
DWC-035B-11						1.750	1.125	0.625	25.3	B	C
DWC-035B-12						2.000	1.282	0.718	22.0	B	C
DWC-035B-12.5						2.250	1.439	0.811	19.5	B	C
DWC-014BB-1	0.188	0.203	0.152	0.014	0.593	0.250	0.075	0.175	3.4	A	B
DWC-014BB-1.5						0.313	0.088	0.225	2.6	A	B
DWC-014BB-2						0.375	0.101	0.274	2.2	A	B
DWC-014BB-3						0.438	0.114	0.324	1.8	A	B
DWC-014BB-4						0.500	0.127	0.373	1.6	A	B
DWC-014BB-4.5						0.563	0.140	0.423	1.4	A	B
DWC-014BB-5						0.625	0.153	0.472	1.3	A	B
DWC-014BB-6						0.750	0.179	0.571	1.0	A	B
DWC-014BB-7						0.875	0.205	0.670	0.9	A	B
DWC-014BB-8						1.000	0.232	0.768	0.8	A	B
DWC-014BB-8.5						1.250	0.284	0.966	0.6	A	B
DWC-014BB-9.5						1.375	0.310	1.065	0.6	A	B
DWC-014BB-10						1.500	0.336	1.164	0.5	A	B
DWC-014BB-11						1.750	0.388	1.362	0.4	A	B
DWC-018BB-1	0.188	0.203	0.143	0.018	2.516	0.250	0.077	0.173	14.6	A	B
DWC-018BB-1.5						0.313	0.089	0.224	11.3	A	B
DWC-018BB-2						0.375	0.101	0.274	9.2	A	B
DWC-018BB-3						0.438	0.113	0.325	7.8	A	B
DWC-018BB-4						0.500	0.122	0.378	7.0	A	B
DWC-018BB-4.5						0.563	0.137	0.426	5.9	A	B
DWC-018BB-5						0.625	0.149	0.476	5.3	A	B
DWC-018BB5.5						0.688	0.161	0.527	4.8	A	B
DWC-018BB-6						0.750	0.173	0.577	4.4	A	B
DWC-018BB-7						0.875	0.196	0.679	3.7	A	B
DWC-018BB-7.5						0.938	0.208	0.730	3.5	A	B
DWC-018BB-8						1.000	0.237	0.763	3.1	A	B
DWC-018BB-8.5						1.125	0.245	0.880	2.9	A	B
DWC-018BB-9						1.250	0.268	0.982	2.6	A	B
DWC-018BB-10	1.500	0.316	1.184	2.1	A	B					
DWC-018BB-11	1.750	0.364	1.386	1.8	A	B					
DWC-020BB-1	0.188	0.203	0.143	0.020	3.212	0.250	0.093	0.157	20.4	A	B
DWC-020BB-1.5						0.313	0.108	0.205	15.7	A	B
DWC-020BB-2						0.375	0.123	0.252	12.8	A	B
DWC-020BB-3						0.438	0.139	0.299	10.8	A	B
DWC-020BB-4						0.500	0.154	0.346	9.3	A	B
DWC-020BB-4.5						0.563	0.170	0.393	8.2	A	B
DWC-020BB-5						0.625	0.185	0.440	7.3	A	B
DWC-020BB5.5						0.688	0.200	0.488	6.6	A	B
DWC-020BB-6						0.750	0.215	0.535	6.0	A	B
DWC-020BB-7						0.875	0.246	0.629	5.1	A	B
DWC-020BB-7.5						0.938	0.262	0.676	4.8	A	B

Note: Wire Dia. up to .098" is Music Wire (MW); .105" and over is Oil Tempered Wire (OT). Stainless available up to .135" wire size. Above rates and loads are multiplied by .833 when using stainless. For prices from 1 to 100 see Price Index. Please inquire if you need a size not listed above.

STOCK COMPRESSION SPRINGS

Music Wire/Oil Tempered & Stainless (See Below)

Ends Squared and Ground Ends to be Square Within 3 Degrees of Axis

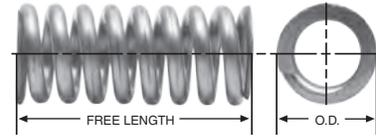

DIAMOND WIRE SPRING STOCK NO.	OUTSIDE DIAMETER	TO WORK IN HOLE DIA.	TO WORK OVER ROD DIA.	WIRE DIA.	APPROX. LOAD AT SOLID HT.	FREE LENGTH	SOLID HT.	TOTAL DEFLECTION	SPRING RATE	PRICE GROUP	
	IN.	IN.	IN.	IN.	LB.	IN.	IN.	IN.	LB./IN.	OT/MW	SS
DWC-020BB-8	0.188	0.203	0.143	0.020	3.212	1.000	0.277	0.723	4.5	A	B
DWC-020BB-8.5						1.125	0.307	0.818	4.0	A	B
DWC-020BB-9						1.250	0.338	0.912	3.5	A	B
DWC-020BB-10						1.500	0.399	1.101	2.9	A	B
DWC-020BB-11						1.750	0.416	1.334	2.5	A	B
DWC-023BB-1	0.188	0.203	0.140	0.023	4.000	0.250	0.120	0.130	30.8	A	B
DWC-023BB-1.5						0.313	0.142	0.171	23.5	A	B
DWC-023BB-2						0.375	0.164	0.211	19.1	A	B
DWC-023BB-3						0.438	0.187	0.251	16.0	A	B
DWC-023BB-4						0.500	0.209	0.291	13.8	A	B
DWC-023BB-4.5						0.563	0.231	0.332	12.1	A	B
DWC-023BB-5						0.625	0.253	0.372	10.8	A	B
DWC-023BB-6						0.750	0.298	0.452	8.9	A	B
DWC-023BB-7						0.875	0.342	0.533	7.6	A	B
DWC-023BB-8						1.000	0.387	0.613	6.6	A	B
DWC-023BB-9						1.250	0.476	0.774	5.2	A	B
DWC-023BB-9.5						1.375	0.520	0.855	4.7	A	B
DWC-023BB-10	1.500	0.565	0.935	4.3	A	B					
DWC-023BB-11	1.750	0.653	1.097	3.7	A	B					
DWC-023BB-12	2.000	0.742	1.258	3.2	A	B					
DWC-026BB-1	0.188	0.203	0.128	0.026	7.705	0.250	0.124	0.126	61.1	A	B
DWC-026BB-1.5						0.313	0.146	0.167	46.3	A	B
DWC-026BB-2						0.375	0.168	0.207	37.4	A	B
DWC-026BB-3						0.438	0.191	0.247	31.3	A	B
DWC-026BB-4						0.500	0.213	0.287	27.0	A	B
DWC-026BB-4.5						0.563	0.235	0.328	23.7	A	B
DWC-026BB-5						0.625	0.258	0.367	21.1	A	B
DWC-026BB-5.5						0.688	0.280	0.408	19.0	A	B
DWC-026BB-6						0.750	0.302	0.448	17.3	A	B
DWC-026BB-7						0.875	0.347	0.528	14.7	A	B
DWC-026BB-7.5						0.938	0.369	0.569	13.7	A	B
DWC-026BB-8						1.000	0.398	0.602	12.2	A	B
DWC-026BB-8.5						1.125	0.439	0.686	11.2	A	B
DWC-026BB-9						1.250	0.484	0.766	10.0	A	B
DWC-026BB-10	1.500	0.574	0.926	8.3	A	B					
DWC-026BB-11	1.750	0.663	1.087	7.1	A	B					
DWC-029BB-1	0.188	0.203	0.122	0.029	10.751	0.250	0.140	0.110	97.3	A	B
DWC-029BB-1.5						0.313	0.167	0.146	73.3	A	B
DWC-029BB-2						0.375	0.193	0.182	58.9	A	B
DWC-029BB-3						0.438	0.220	0.218	49.2	A	B
DWC-029BB-4						0.500	0.246	0.254	42.3	A	B
DWC-029BB4.5						0.563	0.272	0.291	37.0	A	B
DWC-029BB-5						0.625	0.298	0.327	33.0	A	B
DWC-029BB-5.5						0.688	0.325	0.363	29.7	A	B
DWC-029BB-6						0.750	0.351	0.399	27.0	A	B
DWC-029BB-6.5						0.813	0.378	0.435	24.7	A	B
DWC-029BB-7						0.875	0.404	0.471	22.9	A	B

Note: Wire Dia. up to .098" is Music Wire (MW); .105" and over is Oil Tempered Wire (OT). Stainless available up to .135" wire size. Above rates and loads are multiplied by .833 when using stainless. For prices from 1 to 100 see Price Index. Please inquire if you need a size not listed above.

STOCK COMPRESSION SPRINGS

Music Wire/Oil Tempered & Stainless (See Below)

Ends Squared and Ground Ends to be Square Within 3 Degrees of Axis

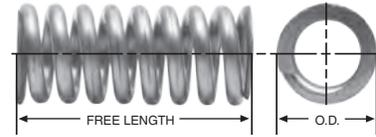

COMPRESSION SPRINGS

DIAMOND WIRE SPRING STOCK NO.	OUTSIDE DIAMETER	TO WORK IN HOLE DIA.	TO WORK OVER ROD DIA.	WIRE DIA.	APPROX. LOAD AT SOLID HT.	FREE LENGTH	SOLID HT.	TOTAL DEFLECTION	SPRING RATE	PRICE GROUP	
	IN.	IN.	IN.	IN.	LB.	IN.	IN.	IN.	LB./IN.	OT/MW	SS
DWC-029BB-7.5	0.188	0.203	0.122	0.029	10.751	0.938	0.431	0.507	21.2	A	B
DWC-029BB8.5						1.125	0.509	0.616	17.5	A	B
DWC-029BB-9						1.250	0.562	0.688	15.7	A	B
DWC-029BB-9.5						1.375	0.615	0.760	14.2	A	B
DWC-029BB-10						1.500	0.668	0.832	12.8	A	B
DWC-029BB-11						1.750	0.773	0.977	11.0	A	B
DWC-029BB-12	2.000	0.879	1.121	9.6	A	B					
DWC-032BB-01	0.188	0.203	0.119	0.032	14.110	0.250	0.157	0.093	151.5	A	B
DWC-032BB-02						0.313	0.188	0.125	113.2	A	B
DWC-032BB-03						0.375	0.218	0.157	90.6	A	B
DWC-032BB-04						0.438	0.249	0.189	75.4	A	B
DWC-032BB-05						0.500	0.279	0.221	64.7	A	B
DWC-032BB-06						0.563	0.310	0.253	56.5	A	B
DWC-032BB-07						0.625	0.340	0.285	50.2	A	B
DWC-032BB-08						0.688	0.371	0.317	45.2	A	B
DWC-032BB-09						0.750	0.401	0.349	41.1	A	B
DWC-032BB-10						0.813	0.432	0.381	37.6	A	B
DWC-032BB-11						0.875	0.463	0.412	34.8	A	B
DWC-032BB-12						0.938	0.493	0.445	32.3	A	B
DWC-032BB-13						1.000	0.524	0.476	30.1	A	B
DWC-032BB-14						1.125	0.588	0.537	26.6	B	C
DWC-032BB-15						1.250	0.646	0.604	23.8	B	C
DWC-032BB-16						1.375	0.707	0.668	21.5	B	C
DWC-032BB-17						1.500	0.768	0.732	19.4	B	C
DWC-032BB-18						1.750	0.891	0.859	16.7	B	C
DWC-032BB-18	2.000	1.013	0.987	14.6	B	C					
DWC-020BC-1	0.210	0.218	0.140	0.020	2.572	0.250	0.088	0.162	14.0	B	C
DWC-020BC-2						0.375	0.117	0.258	8.8	B	C
DWC-020BC-3						0.437	0.131	0.306	7.4	B	C
DWC-020BC-4						0.500	0.145	0.355	6.4	B	C
DWC-020BC-5						0.625	0.174	0.451	5.0	B	C
DWC-020BC-6						0.750	0.202	0.548	4.1	B	C
DWC-020BC-8						1.000	0.259	0.741	3.1	B	C
DWC-020BC-9						1.250	0.317	0.933	2.4	B	C
DWC-020BC-10						1.500	0.374	1.126	2.0	B	C
DWC-020BC-11						1.750	0.431	1.319	1.7	B	C
DWC-020BC-12						2.000	0.488	1.512	1.5	B	C
DWC-022BC-1						0.210	0.218	0.140	0.022	3.000	0.250
DWC-022BC-2	0.375	0.139	0.236	12.0	B						C
DWC-022BC-3	0.437	0.156	0.281	10.2	B						C
DWC-022BC-4	0.500	0.174	0.326	8.8	B						C
DWC-022BC-5	0.625	0.209	0.416	6.8	B						C
DWC-022BC-6	0.750	0.246	0.504	5.5	B						C
DWC-022BC-8	1.000	0.317	0.683	4.0	B						C
DWC-022BC-9	1.250	0.389	0.861	3.2	B						C
DWC-022BC-10	1.500	0.460	1.040	2.5	B						C

Note: Wire Dia. up to .098" is Music Wire (MW); .105" and over is Oil Tempered Wire (OT). Stainless available up to .135" wire size. Above rates and loads are multiplied by .833 when using stainless. For prices from 1 to 100 see Price Index. Please inquire if you need a size not listed above.

STOCK COMPRESSION SPRINGS

Music Wire/Oil Tempered & Stainless (See Below)

Ends Squared and Ground Ends to be Square Within 3 Degrees of Axis

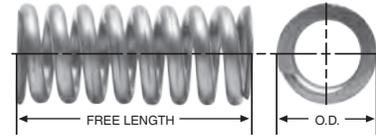

DIAMOND WIRE SPRING STOCK NO.	OUTSIDE DIAMETER	TO WORK IN HOLE DIA.	TO WORK OVER ROD DIA.	WIRE DIA.	APPROX. LOAD AT SOLID HT.	FREE LENGTH	SOLID HT.	TOTAL DEFLECTION	SPRING RATE	PRICE GROUP	
	IN.	IN.	IN.	IN.	LB.	IN.	IN.	IN.	LB./IN.	OT/MW	SS
DWC-022BC-11	0.210	0.218	0.140	0.022	3.000	1.750	0.502	1.248	2.4	B	C
DWC-022BC-12						2.000	0.569	1.431	2.1	B	C
DWC-026BC-1	0.210	0.218	0.140	0.026	4.500	0.250	0.137	0.113	38.2	B	C
DWC-026BC-2						0.375	0.176	0.199	23.2	B	C
DWC-026BC-3						0.437	0.200	0.237	19.5	B	C
DWC-026BC-4						0.500	0.224	0.276	16.8	B	C
DWC-026BC-5						0.625	0.271	0.354	12.7	B	C
DWC-026BC-6						0.750	0.319	0.431	10.8	B	C
DWC-026BC-8						1.000	0.416	0.584	7.7	B	C
DWC-026BC-9						1.250	0.510	0.740	6.0	B	C
DWC-026BC-10						1.500	0.605	0.895	5.0	B	C
DWC-026BC-11						1.750	0.695	1.055	4.3	B	C
DWC-026BC-12						2.000	0.789	1.211	3.7	B	C
DWC-029BC-1						0.210	0.218	0.140	0.029	6.400	0.250
DWC-029BC-2	0.375	0.196	0.179	36.0	B						C
DWC-029BC-3	0.437	0.224	0.213	30.0	B						C
DWC-029BC-4	0.500	0.251	0.249	25.7	B						C
DWC-029BC-5	0.625	0.306	0.319	20.1	B						C
DWC-029BC-6	0.750	0.360	0.390	16.5	B						C
DWC-029BC-8	1.000	0.470	0.530	12.1	B						C
DWC-029BC-9	1.250	0.579	0.671	9.6	B						C
DWC-029BC-10	1.500	0.688	0.812	7.9	B						C
DWC-029BC-11	1.750	0.797	0.953	6.7	B						C
DWC-029BC-12	2.000	0.906	1.094	5.9	B						C
DWC-032BC-1	0.210	0.218	0.125	0.032	8.400						0.250
DWC-032BC-2						0.375	0.221	0.154	54.5	B	C
DWC-032BC-3						0.437	0.252	0.185	45.5	B	C
DWC-032BC-4						0.500	0.284	0.216	38.9	B	C
DWC-032BC-5						0.625	0.347	0.278	30.3	B	C
DWC-032BC-6						0.750	0.410	0.340	24.8	B	C
DWC-032BC-8						1.000	0.536	0.464	18.1	B	C
DWC-032BC-9						1.250	0.662	0.588	14.3	B	C
DWC-032BC-10						1.500	0.788	0.712	11.8	B	C
DWC-032BC-11						1.750	0.914	0.836	10.1	B	C
DWC-032BC-12						2.000	1.040	0.960	8.8	B	C
DWC-016BD-1						0.218	0.234	0.178	0.016	0.825	0.250
DWC-016BD-1.5	0.313	0.086	0.227	3.7	B						C
DWC-016BD-2	0.375	0.098	0.277	3.0	B						C
DWC-016BD-3	0.438	0.110	0.328	2.5	B						C
DWC-016BD-4	0.500	0.122	0.378	2.2	B						C
DWC-016BD-4.5	0.563	0.134	0.429	1.9	B						C
DWC-016BD-5	0.625	0.146	0.479	1.7	B						C
DWC-016BD-6	0.750	0.170	0.580	1.4	B						C
DWC-016BD-7	0.875	0.194	0.681	1.2	B						C
DWC-016BD-8	1.000	0.218	0.782	1.1	B						C
DWC-016BD-9	1.250	0.266	0.984	0.8	B						C
DWC-016BD-9.5	1.375	0.290	1.085	0.8	B						C

COMPRESSION SPRINGS

Note: Wire Dia. up to .098" is Music Wire (MW); .105" and over is Oil Tempered Wire (OT). Stainless available up to .135" wire size. Above rates and loads are multiplied by .833 when using stainless. For prices from 1 to 100 see Price Index. Please inquire if you need a size not listed above.

STOCK COMPRESSION SPRINGS

Music Wire/Oil Tempered & Stainless (See Below)

Ends Squared and Ground Ends to be Square Within 3 Degrees of Axis

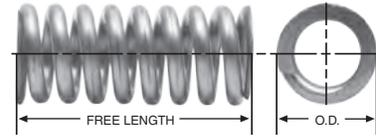

COMPRESSION SPRINGS

DIAMOND WIRE SPRING STOCK NO.	OUTSIDE DIAMETER	TO WORK IN HOLE DIA.	TO WORK OVER ROD DIA.	WIRE DIA.	APPROX. LOAD AT SOLID HT.	FREE LENGTH	SOLID HT.	TOTAL DEFLECTION	SPRING RATE	PRICE GROUP	
	IN.	IN.	IN.	IN.	LB.	IN.	IN.	IN.	LB./IN.	OT/MW	SS
DWC-016BD-10	0.218	0.234	0.178	0.016	0.825	1.500	0.314	1.186	0.7	B	C
DWC-016BD-11						1.750	0.362	1.388	0.6	B	C
DWC-018BD-1	0.218	0.234	0.174	0.018	0.985	0.250	0.094	0.156	6.3	B	C
DWC-018BD-1.5						0.313	0.111	0.202	4.9	B	C
DWC-018BD-2						0.375	0.128	0.247	4.0	B	C
DWC-018BD-3						0.438	0.145	0.293	3.4	B	C
DWC-018BD-4						0.500	0.162	0.338	2.9	B	C
DWC-018BD-4.5						0.563	0.179	0.384	2.6	B	C
DWC-018BD-5						0.625	0.195	0.430	2.3	B	C
DWC-018BD-6						0.750	0.229	0.521	1.9	B	C
DWC-018BD-7						0.875	0.263	0.612	1.6	B	C
DWC-018BD-8						1.000	0.296	0.704	1.4	B	C
DWC-018BD-9						1.250	0.364	0.886	1.1	B	C
DWC-018BD-9.5						1.375	0.397	0.978	1.0	B	C
DWC-018BD-10	1.500	0.431	1.069	0.9	B	C					
DWC-018BD-11	1.750	0.499	1.251	0.8	B	C					
DWC-020BD-1	0.218	0.234	0.169	0.020	2.387	0.250	0.085	0.165	14.4	B	C
DWC-020BD-1.5						0.313	0.098	0.215	11.1	B	C
DWC-020BD-2						0.375	0.111	0.264	9.0	B	C
DWC-020BD-3						0.438	0.124	0.314	7.6	B	C
DWC-020BD-4						0.500	0.137	0.363	6.6	B	C
DWC-020BD-4.5						0.563	0.151	0.412	5.8	B	C
DWC-020BD-5						0.625	0.164	0.461	5.2	B	C
DWC-020BD-5.5						0.688	0.177	0.511	4.7	B	C
DWC-020BD-6						0.750	0.190	0.560	4.3	B	C
DWC-020BD-7						0.875	0.216	0.659	3.6	B	C
DWC-020BD-8						1.000	0.242	0.758	3.2	B	C
DWC-020BD9						1.250	0.295	0.955	2.5	B	C
DWC-020BD-9.5	1.375	0.321	1.054	2.3	B	C					
DWC-020BD-10	1.500	0.348	1.152	2.1	B	C					
DWC-020BD-11	1.750	0.400	1.350	1.8	B	C					
DWC-028BD-1	0.218	0.234	0.154	0.028	6.714	0.250	0.128	0.122	54.7	B	C
DWC-028BD-1.5						0.313	0.151	0.162	41.3	B	C
DWC-028BD-2						0.375	0.174	0.201	33.3	B	C
DWC-028BD-3						0.438	0.197	0.241	27.8	B	C
DWC-028BD-4						0.500	0.219	0.281	23.9	B	C
DWC-028BD-4.5						0.563	0.242	0.321	20.9	B	C
DWC-028BD-5						0.625	0.265	0.360	18.7	B	C
DWC-028BD-5.5						0.688	0.288	0.400	16.8	B	C
DWC-028BD-6						0.750	0.311	0.439	15.3	B	C
DWC-028BD-7						0.875	0.356	0.519	13.0	B	C
DWC-028BD-8						1.000	0.402	0.598	11.2	B	C
DWC-028BD9						1.250	0.493	0.757	8.9	B	C
DWC-028BD-9.5	1.375	0.539	0.836	8.1	B	C					
DWC-028BD-10	1.500	0.584	0.916	7.4	B	C					
DWC-028BD-11	1.750	0.676	1.074	6.3	B	C					

Note: Wire Dia. up to .098" is Music Wire (MW); .105" and over is Oil Tempered Wire (OT). Stainless available up to .135" wire size. Above rates and loads are multiplied by .833 when using stainless. For prices from 1 to 100 see Price Index. Please inquire if you need a size not listed above.

STOCK COMPRESSION SPRINGS

Music Wire/Oil Tempered & Stainless (See Below)

Ends Squared and Ground Ends to be Square Within 3 Degrees of Axis

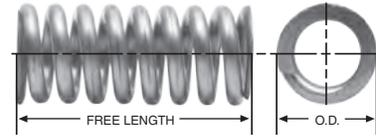

DIAMOND WIRE SPRING STOCK NO.	OUTSIDE DIAMETER	TO WORK IN HOLE DIA.	TO WORK OVER ROD DIA.	WIRE DIA.	APPROX. LOAD AT SOLID HT.	FREE LENGTH	SOLID HT.	TOTAL DEFLECTION	SPRING RATE	PRICE GROUP	
	IN.	IN.	IN.	IN.	LB.	IN.	IN.	IN.	LB./IN.	OT/MW	SS
DWC-016C-1	0.240	0.250	0.202	0.016	1.207	0.250	0.056	0.194	6.2	A	B
DWC-016C-1.5						0.312	0.063	0.249	4.8	A	B
DWC-016C-2						0.375	0.070	0.305	3.9	A	B
DWC-016C-3						0.438	0.076	0.362	3.3	A	B
DWC-016C-4						0.500	0.083	0.417	2.9	A	B
DWC-016C-4.5						0.562	0.089	0.473	2.6	A	B
DWC-016C-5						0.625	0.096	0.529	2.3	A	B
DWC-016C-5.5						0.687	0.103	0.584	2.1	A	B
DWC-016C-6						0.750	0.110	0.640	1.9	A	B
DWC-016C-6.5						0.812	0.116	0.696	1.7	B	C
DWC-016C-7						0.875	0.123	0.752	1.6	B	C
DWC-016C-7.5						0.937	0.129	0.808	1.5	B	C
DWC-016C-8	1.000	0.136	0.864	1.4	B	C					
DWC-016C-9	1.250	0.163	1.087	1.1	B	C					
DWC-016C-10	1.500	0.190	1.310	0.9	B	C					
DWC-016C-11	1.750	0.213	1.537	0.8	B	C					
DWC-016C-12	2.000	0.239	1.761	0.7	B	C					
DWC-018C-1	0.240	0.250	0.198	0.018	1.735	0.250	0.065	0.185	9.4	A	B
DWC-018C-1.5						0.312	0.074	0.238	7.3	A	B
DWC-018C-2						0.375	0.082	0.293	5.9	A	B
DWC-018C-3						0.438	0.091	0.347	5.0	A	B
DWC-018C-4						0.500	0.099	0.401	4.3	A	B
DWC-018C-4.5						0.562	0.107	0.455	3.8	A	B
DWC-018C-5						0.625	0.115	0.510	3.4	A	B
DWC-018C-5.5						0.687	0.124	0.563	3.1	A	B
DWC-018C-6						0.750	0.132	0.618	2.8	A	B
DWC-018C-6.5						0.812	0.140	0.672	2.6	B	C
DWC-018C-7						0.875	0.148	0.727	2.4	B	C
DWC-018C-7.5						0.937	0.157	0.780	2.2	B	C
DWC-018C-8	1.000	0.165	0.835	2.1	B	C					
DWC-018C-9	1.250	0.198	1.052	1.7	B	C					
DWC-018C-10	1.500	0.231	1.269	1.3	B	C					
DWC-018C-11	1.750	0.259	1.491	1.2	B	C					
DWC-018C-12	2.000	0.304	1.696	1.0	B	C					
DWC-020C-1	0.240	0.250	0.187	0.020	2.125	0.250	0.091	0.159	14.1	A	B
DWC-020C-1.5						0.313	0.094	0.219	8.6	A	B
DWC-020C-2						0.375	0.110	0.265	8.7	A	B
DWC-020C-3						0.437	0.118	0.319	7.4	A	B
DWC-020C-4						0.500	0.127	0.373	6.4	A	B
DWC-020C-4.5						0.563	0.144	0.419	4.4	A	B
DWC-020C-5						0.625	0.145	0.480	5.1	A	B
DWC-020C-5.5						0.688	0.170	0.518	3.5	A	B
DWC-020C-6						0.750	0.164	0.586	4.2	A	B
DWC-020C-6.5						0.813	0.194	0.619	2.9	B	C
DWC-020C-7						0.875	0.182	0.693	3.5	B	C
DWC-020C-8						1.000	0.200	0.800	3.1	B	C
DWC-020C-9	1.250	0.236	1.014	2.4	B	C					

COMPRESSION SPRINGS

Note: Wire Dia. up to .098" is Music Wire (MW); .105" and over is Oil Tempered Wire (OT). Stainless available up to .135" wire size. Above rates and loads are multiplied by .833 when using stainless. For prices from 1 to 100 see Price Index. Please inquire if you need a size not listed above.

STOCK COMPRESSION SPRINGS

Music Wire/Oil Tempered & Stainless (See Below)

Ends Squared and Ground Ends to be Square Within 3 Degrees of Axis

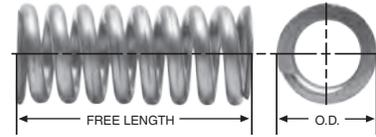

COMPRESSION SPRINGS

DIAMOND WIRE SPRING STOCK NO.	OUTSIDE DIAMETER	TO WORK IN HOLE DIA.	TO WORK OVER ROD DIA.	WIRE DIA.	APPROX. LOAD AT SOLID HT.	FREE LENGTH	SOLID HT.	TOTAL DEFLECTION	SPRING RATE	PRICE GROUP	
	IN.	IN.	IN.	IN.	LB.	IN.	IN.	IN.	LB./IN.	OT/MW	SS
DWC-020C-10	0.240	0.250	0.187	0.020	2.125	1.500	0.273	1.227	2.0	B	C
DWC-020C-11						1.750	0.382	1.368	1.3	B	C
DWC-020C-12						2.000	0.432	1.568	1.2	B	C
DWC-022C-1	0.240	0.250	0.187	0.022	2.992	0.250	0.103	0.147	19.5	A	B
DWC-022C-1.5						0.313	0.097	0.216	14.1	A	B
DWC-022C-2						0.375	0.115	0.260	12.3	A	B
DWC-022C-3						0.437	0.131	0.306	9.7	A	B
DWC-022C-4						0.500	0.142	0.358	8.5	A	B
DWC-022C-4.5						0.563	0.144	0.419	8.0	A	B
DWC-022C-5						0.625	0.164	0.461	6.8	A	B
DWC-022C-5.5						0.688	0.177	0.511	6.0	A	B
DWC-022C-6						0.750	0.188	0.562	5.6	A	B
DWC-022C-6.5						0.813	0.199	0.614	5.0	B	C
DWC-022C-8						1.000	0.236	0.764	4.2	B	C
DWC-022C-9						1.250	0.280	0.970	3.3	B	C
DWC-022C-10	1.500	0.325	1.175	2.8	B	C					
DWC-022C-11	1.750	0.390	1.360	2.3	B	C					
DWC-022C-12	2.000	0.440	1.560	2.0	B	C					
DWC-024C-2	0.240	0.250	0.187	0.024	4.113	0.375	0.142	0.233	16.2	A	B
DWC-024C-3						0.437	0.155	0.282	13.7	A	B
DWC-024C-4						0.500	0.168	0.332	11.9	A	B
DWC-024C-4.5						0.563	0.172	0.391	11.0	A	B
DWC-024C-5						0.625	0.193	0.432	9.4	A	B
DWC-024C-5.5						0.688	0.199	0.489	9.0	A	B
DWC-024C-6						0.750	0.221	0.529	7.6	A	B
DWC-024C-6.5						0.813	0.226	0.587	7.3	A	B
DWC-024C-7						0.875	0.248	0.627	6.4	A	B
DWC-024C-8						1.000	0.274	0.726	5.6	A	B
DWC-024C-9						1.250	0.327	0.923	4.5	A	B
DWC-024C-10						1.500	0.379	1.121	3.7	A	B
DWC-024C-11	1.750	0.432	1.318	3.3	B	C					
DWC-024C-12	2.000	0.485	1.515	2.8	B	C					
DWC-026C-1.5	0.240	0.250	0.182	0.026	5.235	0.313	0.128	0.185	27.8	A	B
DWC-026C-2						0.375	0.143	0.232	22.3	A	B
DWC-026C-3						0.437	0.156	0.281	19.9	A	B
DWC-026C-4						0.500	0.169	0.331	17.4	A	B
DWC-026C-4.5						0.563	0.183	0.380	14.0	A	B
DWC-026C-5						0.625	0.208	0.417	12.7	A	B
DWC-026C-5.5						0.688	0.222	0.466	11.0	A	B
DWC-026C-6						0.750	0.246	0.504	10.0	A	B
DWC-026C-6.5						0.813	0.260	0.553	9.0	A	B
DWC-026C-7						0.875	0.281	0.594	8.4	B	C
DWC-026C-8						1.000	0.313	0.687	7.4	B	C
DWC-026C-9						1.250	0.375	0.875	5.9	B	C
DWC-026C-10	1.500	0.437	1.063	4.9	B	C					
DWC-026C-11	1.750	0.483	1.267	4.2	B	C					
DWC-026C-12	2.000	0.545	1.455	3.7	B	C					

Note: Wire Dia. up to .098" is Music Wire (MW); .105" and over is Oil Tempered Wire (OT). Stainless available up to .135" wire size. Above rates and loads are multiplied by .833 when using stainless. For prices from 1 to 100 see Price Index. Please inquire if you need a size not listed above.

STOCK COMPRESSION SPRINGS

Music Wire/Oil Tempered & Stainless (See Below)

Ends Squared and Ground Ends to be Square Within 3 Degrees of Axis

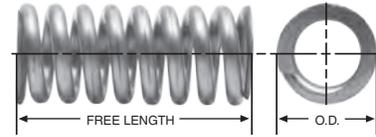

DIAMOND WIRE SPRING STOCK NO.	OUTSIDE DIAMETER	TO WORK IN HOLE DIA.	TO WORK OVER ROD DIA.	WIRE DIA.	APPROX. LOAD AT SOLID HT.	FREE LENGTH	SOLID HT.	TOTAL DEFLECTION	SPRING RATE	PRICE GROUP	
	IN.	IN.	IN.	IN.	LB.	IN.	IN.	IN.	LB./IN.	OT/MW	SS
DWC-029C-2	0.240	0.250	0.172	0.029	6.705	0.375	0.185	0.190	32.0	A	B
DWC-029C-3						0.437	0.203	0.234	27.0	A	B
DWC-029C-4						0.500	0.221	0.279	23.3	A	B
DWC-029C-4.5						0.563	0.230	0.333	20.6	A	B
DWC-029C-5						0.625	0.258	0.367	18.4	A	B
DWC-029C-5.5						0.688	0.268	0.420	16.8	A	B
DWC-029C-6						0.750	0.298	0.452	14.9	A	B
DWC-029C-6.5						0.813	0.310	0.503	14.0	A	B
DWC-029C-7						0.875	0.337	0.538	12.6	A	B
DWC-029C-8						1.000	0.374	0.626	11.0	A	B
DWC-029C-9						1.250	0.450	0.800	8.7	A	B
DWC-029C-10						1.500	0.526	0.974	7.2	B	C
DWC-029C-11	1.750	0.607	1.143	6.3	B	C					
DWC-029C-12	2.000	0.690	1.310	5.5	B	C					
DWC-032C-1.5	0.240	0.250	0.170	0.032	9.646	0.313	0.161	0.152	62.0	A	B
DWC-032C-2						0.375	0.184	0.191	53.8	A	B
DWC-032C-3						0.437	0.209	0.228	43.2	A	B
DWC-032C-4						0.500	0.232	0.268	36.8	A	B
DWC-032C-4.5						0.563	0.249	0.314	32.0	A	B
DWC-032C-5						0.625	0.279	0.346	28.0	A	B
DWC-032C-5.5						0.688	0.297	0.391	25.0	A	B
DWC-032C-6						0.750	0.335	0.415	21.9	A	B
DWC-032C-6.5						0.813	0.353	0.460	20.0	A	B
DWC-032C-7						0.875	0.384	0.491	18.4	A	B
DWC-032C-7.5						0.938	0.393	0.545	17.5	A	B
DWC-032C-8						1.000	0.431	0.569	15.9	A	B
DWC-032C-9	1.250	0.526	0.724	12.5	B	C					
DWC-032C-9.5	1.375	0.549	0.826	12.0	B	C					
DWC-032C-10	1.500	0.616	0.884	10.3	B	C					
DWC-032C-11	1.750	0.680	1.070	9.6	B	C					
DWC-032C-12	2.000	0.772	1.228	8.4	B	C					
DWC-035C-1.5	0.240	0.250	0.164	0.035	11.262	0.313	0.192	0.121	90.0	A	B
DWC-035C-2						0.375	0.235	0.140	67.3	A	B
DWC-035C-3						0.437	0.260	0.177	56.4	A	B
DWC-035C-4						0.500	0.286	0.214	48.5	A	B
DWC-035C-4.5						0.563	0.286	0.277	45.0	A	B
DWC-035C-5						0.625	0.336	0.289	37.9	A	B
DWC-035C-5.5						0.688	0.339	0.349	36.0	A	B
DWC-035C-6						0.750	0.391	0.359	30.7	A	B
DWC-035C-6.5						0.813	0.392	0.421	29.3	A	B
DWC-035C-7						0.875	0.445	0.430	25.7	A	B
DWC-035C-7.5						0.938	0.462	0.476	24.4	A	B
DWC-035C-8						1.000	0.496	0.504	22.4	A	B
DWC-035C-9	1.250	0.601	0.649	17.7	A	B					
DWC-035C-9.5	1.375	0.650	0.725	16.0	A	B					
DWC-035C-10	1.500	0.706	0.794	14.6	A	B					
DWC-035C-11	1.750	0.807	0.943	12.4	B	C					

COMPRESSION SPRINGS

Note: Wire Dia. up to .098" is Music Wire (MW); .105" and over is Oil Tempered Wire (OT). Stainless available up to .135" wire size. Above rates and loads are multiplied by .833 when using stainless. For prices from 1 to 100 see Price Index. Please inquire if you need a size not listed above.

STOCK COMPRESSION SPRINGS

Music Wire/Oil Tempered & Stainless (See Below)

Ends Squared and Ground Ends to be Square Within 3 Degrees of Axis

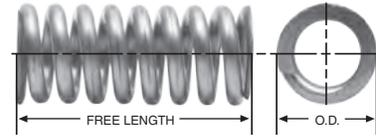

COMPRESSION SPRINGS

DIAMOND WIRE SPRING STOCK NO.	OUTSIDE DIAMETER	TO WORK IN HOLE DIA.	TO WORK OVER ROD DIA.	WIRE DIA.	APPROX. LOAD AT SOLID HT.	FREE LENGTH	SOLID HT.	TOTAL DEFLECTION	SPRING RATE	PRICE GROUP	
	IN.	IN.	IN.	IN.	LB.	IN.	IN.	IN.	LB./IN.	OT/MW	SS
DWC-035C-12	0.240	0.250	0.164	0.035	11.262	2.000	0.913	1.087	11.0	B	C
DWC-035C-12.5						2.250	1.017	1.233	9.8	B	C
DWC-035C-13						2.500	1.121	1.379	8.9	B	C
DWC-038C-1.5	0.240	0.250	0.158	0.038	15.501	0.313	0.191	0.122	127.0	A	B
DWC-038C-2						0.375	0.237	0.138	101.5	A	B
DWC-038C-3						0.437	0.265	0.172	84.4	A	B
DWC-038C-4						0.500	0.294	0.206	72.3	A	B
DWC-038C-4.5						0.563	0.305	0.258	64.0	A	B
DWC-038C-5						0.625	0.350	0.275	56.4	A	B
DWC-038C-5.5						0.688	0.362	0.326	51.0	A	B
DWC-038C-6						0.750	0.407	0.343	46.1	A	B
DWC-038C-6.5						0.813	0.419	0.394	42.0	A	B
DWC-038C-7						0.875	0.474	0.401	38.0	A	B
DWC-038C-7.5						0.938	0.496	0.442	35.0	A	B
DWC-038C-8						1.000	0.541	0.459	32.3	A	B
DWC-038C-8.5						1.125	0.581	0.544	29.0	A	B
DWC-038C-9						1.250	0.653	0.597	25.8	A	B
DWC-038C-9.5						1.375	0.715	0.660	23.0	A	B
DWC-038C-10						1.500	0.768	0.732	21.4	A	B
DWC-038C-11	1.750	0.879	0.871	18.0	B	C					
DWC-038C-12	2.000	0.994	1.006	16.0	B	C					
DWC-038C-12.5	2.250	1.140	1.110	14.2	B	C					
DWC-038C-13	2.500	1.240	1.260	12.6	B	C					
DWC-040C-1.5	0.240	0.250	0.154	0.040	15.299	0.313	0.214	0.099	155.0	A	B
DWC-040C-2						0.375	0.274	0.101	119.4	A	B
DWC-040C-3						0.437	0.305	0.132	99.5	A	B
DWC-040C-4						0.500	0.336	0.164	85.3	A	B
DWC-040C-4.5						0.563	0.350	0.213	74.0	A	B
DWC-040C-5						0.625	0.397	0.228	66.4	A	B
DWC-040C-5.5						0.688	0.414	0.274	60.0	A	B
DWC-040C-6						0.750	0.464	0.286	53.5	A	B
DWC-040C-6.5						0.813	0.482	0.331	48.5	A	B
DWC-040C-7						0.875	0.531	0.344	44.8	A	B
DWC-040C-7.5						0.938	0.550	0.388	42.0	A	B
DWC-040C-8						1.000	0.592	0.408	39.0	A	B
DWC-040C-8.5						1.125	0.650	0.475	35.0	A	B
DWC-040C-9						1.250	0.721	0.529	30.6	A	B
DWC-040C-9.5						1.375	0.782	0.593	27.5	A	B
DWC-040C-10						1.500	0.849	0.651	25.2	A	B
DWC-040C-11	1.750	0.982	0.768	21.7	B	C					
DWC-040C-12	2.000	1.114	0.886	19.2	B	C					
DWC-040C-12.5	2.250	1.250	1.000	16.7	B	C					
DWC-040C-13	2.500	1.382	1.118	15.0	B	C					
DWC-042C-2	0.240	0.250	0.140	0.042	17.808	0.375	0.272	0.103	151.0	A	B
DWC-042C-3						0.437	0.310	0.127	123.0	A	B
DWC-042C-4						0.500	0.343	0.157	106.0	A	B
DWC-042C-4.5						0.563	0.358	0.205	94.0	A	B

Note: Wire Dia. up to .098" is Music Wire (MW); .105" and over is Oil Tempered Wire (OT). Stainless available up to .135" wire size. Above rates and loads are multiplied by .833 when using stainless. For prices from 1 to 100 see Price Index. Please inquire if you need a size not listed above.

STOCK COMPRESSION SPRINGS

Music Wire/Oil Tempered & Stainless (See Below)

Ends Squared and Ground Ends to be Square Within 3 Degrees of Axis

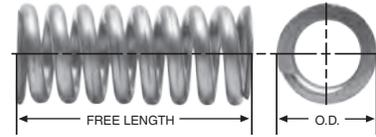

DIAMOND WIRE SPRING STOCK NO.	OUTSIDE DIAMETER	TO WORK IN HOLE DIA.	TO WORK OVER ROD DIA.	WIRE DIA.	APPROX. LOAD AT SOLID HT.	FREE LENGTH	SOLID HT.	TOTAL DEFLECTION	SPRING RATE	PRICE GROUP	
	IN.	IN.	IN.	IN.	LB.	IN.	IN.	IN.	LB./IN.	OT/MW	SS
DWC-042C-5	0.240	0.250	0.140	0.042	17.808	0.625	0.401	0.224	85.0	A	B
DWC-042C-5.5						0.688	0.421	0.267	75.0	A	B
DWC-042C-6						0.750	0.499	0.251	64.0	A	B
DWC-042C-6.5						0.813	0.505	0.308	60.0	A	B
DWC-042C-7						0.875	0.556	0.319	56.0	A	B
DWC-042C-7.5						0.938	0.588	0.350	51.0	A	B
DWC-042C-8						1.000	0.631	0.369	48.0	A	B
DWC-042C-8.5						1.125	0.694	0.431	42.0	A	B
DWC-042C-9						1.250	0.778	0.472	37.5	A	B
DWC-042C-9.5						1.375	0.841	0.534	34.0	A	B
DWC-042C-10						1.500	0.933	0.567	30.5	A	B
DWC-042C-11						1.750	1.017	0.733	26.5	B	C
DWC-042C-12						2.000	1.183	0.817	23.0	B	C
DWC-042C-12.5	2.250	1.308	0.942	20.5	B	C					
DWC-042C-13	2.500	1.425	1.075	17.8	B	C					
DWC-045C-2	0.240	0.250	0.144	0.045	22.643	0.375	0.271	0.104	215.2	A	B
DWC-045C-3						0.438	0.311	0.127	176.2	A	B
DWC-045C-4						0.500	0.350	0.150	149.6	A	B
DWC-045C-4.5						0.562	0.389	0.173	129.9	A	B
DWC-045C-5						0.625	0.428	0.197	114.6	A	B
DWC-045C-5.5						0.687	0.467	0.220	102.8	A	B
DWC-045C-6						0.750	0.506	0.244	92.9	A	B
DWC-045C-6.5						0.812	0.545	0.267	84.9	A	B
DWC-045C-7						0.875	0.585	0.290	78.1	A	B
DWC-045C-7.5						0.937	0.624	0.313	72.4	A	B
DWC-045C-8						1.000	0.663	0.337	67.4	A	B
DWC-045C-8.5						1.125	0.742	0.383	59.2	A	B
DWC-045C-9						1.250	0.820	0.430	52.9	A	B
DWC-045C-10	1.500	0.977	0.523	43.5	A	B					
DWC-045C-11	1.750	1.133	0.617	37.0	B	C					
DWC-045C-12	2.000	1.290	0.710	32.1	B	C					
DWC-045C-12.5	2.250	1.447	0.803	28.4	B	C					
DWC-045C-13	2.500	1.604	0.896	25.4	B	C					
DWC-020CD-1	0.250	0.265	0.200	0.020	2.139	0.250	0.074	0.176	12.2	A	B
DWC-020CD-1.5						0.313	0.084	0.229	9.4	A	B
DWC-020CD-2						0.375	0.094	0.281	7.6	A	B
DWC-020CD-3						0.438	0.104	0.334	6.4	A	B
DWC-020CD-4						0.500	0.114	0.386	5.6	A	B
DWC-020CD-4.5						0.563	0.124	0.439	4.9	A	B
DWC-020CD-5						0.625	0.134	0.491	4.4	A	B
DWC-020CD-5.5						0.688	0.144	0.544	3.9	A	B
DWC-020CD-6						0.750	0.154	0.596	3.6	A	B
DWC-020CD-6.5						0.813	0.164	0.649	3.3	A	B
DWC-020CD-7						0.875	0.173	0.702	3.1	A	B
DWC-020CD-8						1.000	0.193	0.807	2.7	A	B
DWC-020CD-8.5						1.250	0.233	1.017	2.1	A	B
DWC-020CD-9.5	1.375	0.254	1.121	1.9	A	B					

COMPRESSION SPRINGS

Note: Wire Dia. up to .098" is Music Wire (MW); .105" and over is Oil Tempered Wire (OT). Stainless available up to .135" wire size. Above rates and loads are multiplied by .833 when using stainless. For prices from 1 to 100 see Price Index. Please inquire if you need a size not listed above.

STOCK COMPRESSION SPRINGS

Music Wire/Oil Tempered & Stainless (See Below)

Ends Squared and Ground Ends to be Square Within 3 Degrees of Axis

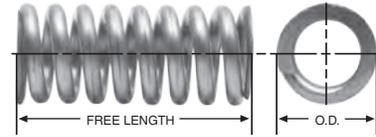

COMPRESSION SPRINGS

DIAMOND WIRE SPRING STOCK NO.	OUTSIDE DIAMETER	TO WORK IN HOLE DIA.	TO WORK OVER ROD DIA.	WIRE DIA.	APPROX. LOAD AT SOLID HT.	FREE LENGTH	SOLID HT.	TOTAL DEFLECTION	SPRING RATE	PRICE GROUP	
	IN.	IN.	IN.	IN.	LB.	IN.	IN.	IN.	LB./IN.	OT/MW	SS
DWC-020CD-10	0.250	0.265	0.200	0.020	2.139	1.500	0.274	1.226	1.7	B	C
DWC-020CD-11						1.750	0.314	1.436	1.5	B	C
DWC-020CD-12						2.000	0.354	1.646	1.3	A	B
DWC-026CD-2	0.250	0.265	0.188	0.026	5.870	0.375	0.122	0.253	23.6	A	B
DWC-026CD-3						0.438	0.136	0.302	19.8	A	B
DWC-026CD-4						0.500	0.149	0.351	17.0	A	B
DWC-026CD-4.5						0.563	0.163	0.400	14.9	A	B
DWC-026CD-5						0.625	0.177	0.448	13.2	A	B
DWC-026CD-5.5						0.688	0.191	0.497	11.8	A	B
DWC-026CD-6						0.750	0.206	0.544	10.7	A	B
DWC-026CD-6.5						0.813	0.220	0.593	9.8	A	B
DWC-026CD-7						0.875	0.235	0.640	9.0	A	B
DWC-026CD-7.5						0.938	0.250	0.688	8.3	A	B
DWC-026CD-8						1.000	0.269	0.731	7.4	A	B
DWC-026CD-9						1.250	0.309	0.941	6.4	A	B
DWC-026CD-10	1.500	0.363	1.137	5.3	A	B					
DWC-026CD-11	1.750	0.416	1.334	4.5	B	C					
DWC-026CD-12	2.000	0.470	1.530	3.9	B	C					
DWC-035CD-1	0.250	0.265	0.172	0.035	10.030	0.313	0.180	0.133	75.1	A	B
DWC-035CD-2						0.375	0.208	0.167	59.8	A	B
DWC-035CD-3						0.438	0.236	0.202	49.6	A	B
DWC-035CD-4						0.500	0.264	0.236	42.4	A	B
DWC-035CD-4.5						0.563	0.292	0.271	37.0	A	B
DWC-035CD-5						0.625	0.320	0.305	32.9	A	B
DWC-035CD-5.5						0.688	0.348	0.340	29.5	A	B
DWC-035CD-6						0.750	0.376	0.374	26.8	A	B
DWC-035CD-6.5						0.813	0.404	0.409	24.5	A	B
DWC-035CD-7						0.875	0.432	0.443	22.7	A	B
DWC-035CD-7.5						0.938	0.460	0.478	21.0	A	B
DWC-035CD-8						1.000	0.488	0.512	19.6	A	B
DWC-035CD-9						1.250	0.600	0.650	15.5	A	B
DWC-035CD-9.5						1.375	0.656	0.719	14.0	A	B
DWC-035CD-10						1.500	0.712	0.788	12.8	A	B
DWC-035CD-11						1.750	0.824	0.926	10.9	B	C
DWC-035CD-12	2.000	0.936	1.064	9.4	B	C					
DWC-035CD-12.5	2.250	1.048	1.202	8.4	B	C					
DWC-035CD-13	2.500	1.160	1.340	7.5	B	C					
DWC-022D-2	0.300	0.313	0.234	0.022	2.188	0.375	0.104	0.271	9.0	A	B
DWC-022D-3						0.437	0.111	0.326	7.6	A	B
DWC-022D-4						0.500	0.109	0.391	6.6	A	B
DWC-022D-4.5						0.563	0.111	0.452	6.0	A	B
DWC-022D-5						0.625	0.126	0.499	5.0	A	B
DWC-022D-5.5						0.688	0.128	0.560	4.5	A	B
DWC-022D-6						0.750	0.142	0.608	4.1	A	B
DWC-022D-6.5						0.813	0.155	0.658	3.5	A	B
DWC-022D-7	0.875	0.154	0.721	3.6	A	B					
DWC-022D-8	1.000	0.175	0.825	3.2	A	B					

Note: Wire Dia. up to .098" is Music Wire (MW); .105" and over is Oil Tempered Wire (OT). Stainless available up to .135" wire size. Above rates and loads are multiplied by .833 when using stainless. For prices from 1 to 100 see Price Index. Please inquire if you need a size not listed above.

STOCK COMPRESSION SPRINGS

Music Wire/Oil Tempered & Stainless (See Below)

Ends Squared and Ground Ends to be Square Within 3 Degrees of Axis

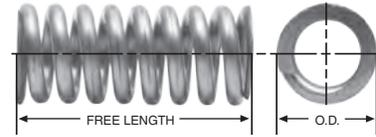

DIAMOND WIRE SPRING STOCK NO.	OUTSIDE DIAMETER	TO WORK IN HOLE DIA.	TO WORK OVER ROD DIA.	WIRE DIA.	APPROX. LOAD AT SOLID HT.	FREE LENGTH	SOLID HT.	TOTAL DEFLECTION	SPRING RATE	PRICE GROUP	
	IN.	IN.	IN.	IN.	LB.	IN.	IN.	IN.	LB./IN.	OT/MW	SS
DWC-022D-9	0.300	0.313	0.234	0.022	2.188	1.250	0.204	1.046	2.5	A	B
DWC-022D-10						1.500	0.232	1.268	2.1	A	B
DWC-022D-11						1.750	0.269	1.481	1.7	B	C
DWC-022D-12						2.000	0.313	1.687	1.4	B	C
DWC-022D-12.5						2.250	0.357	1.893	1.2	B	C
DWC-022D-13						2.500	0.391	2.109	1.1	B	C
DWC-026D-3	0.300	0.313	0.234	0.026	4.103	0.437	0.130	0.307	13.3	A	B
DWC-026D-4						0.500	0.143	0.357	11.1	A	B
DWC-026D-4.5						0.563	0.144	0.419	10.0	A	B
DWC-026D-5						0.625	0.162	0.463	8.9	A	B
DWC-026D-5.5						0.688	0.164	0.524	8.0	A	B
DWC-026D-6						0.750	0.182	0.568	7.4	A	B
DWC-026D-6.5						0.813	0.183	0.630	7.0	A	B
DWC-026D-7						0.875	0.206	0.669	6.1	A	B
DWC-026D-7.5						0.938	0.209	0.729	5.5	A	B
DWC-026D-8						1.000	0.234	0.766	5.1	A	B
DWC-026D-9						1.250	0.272	0.978	4.3	A	B
DWC-026D-10						1.500	0.313	1.187	3.5	A	B
DWC-026D-11						1.750	0.343	1.407	3.0	B	C
DWC-026D-12						2.000	0.384	1.616	2.6	B	C
DWC-026D-12.5	2.250	0.436	1.814	2.3	B	C					
DWC-026D-13	2.500	0.479	2.021	2.1	B	C					
DWC-030D-3	0.300	0.313	0.218	0.030	5.833	0.437	0.172	0.265	21.5	A	B
DWC-030D-4						0.500	0.185	0.315	18.6	A	B
DWC-030D-4.5						0.563	0.183	0.380	15.0	A	B
DWC-030D-5						0.625	0.212	0.413	14.6	A	B
DWC-030D-5.5						0.688	0.213	0.475	12.0	A	B
DWC-030D-6						0.750	0.240	0.510	11.9	A	B
DWC-030D-6.5						0.813	0.246	0.567	10.0	A	B
DWC-030D-7						0.875	0.268	0.607	10.0	A	B
DWC-030D-7.5						0.938	0.276	0.662	8.6	A	B
DWC-030D-8						1.000	0.294	0.706	8.7	A	B
DWC-030D-9						1.250	0.348	0.902	6.9	B	C
DWC-030D-10						1.500	0.402	1.098	5.7	B	C
DWC-030D-11						1.750	0.474	1.276	4.5	B	C
DWC-030D-12						2.000	0.537	1.463	3.8	B	C
DWC-030D-12.5	2.250	0.608	1.642	3.4	B	C					
DWC-030D-13	2.500	0.670	1.830	3.1	B	C					
DWC-032D-3	0.300	0.313	0.218	0.032	7.287	0.437	0.175	0.262	27.3	A	B
DWC-032D-4						0.500	0.190	0.310	23.6	A	B
DWC-032D-4.5						0.563	0.201	0.362	20.0	A	B
DWC-032D-5						0.625	0.223	0.402	18.2	A	B
DWC-032D-5.5						0.688	0.241	0.447	16.0	A	B
DWC-032D-6						0.750	0.255	0.495	14.9	A	B
DWC-032D-6.5						0.813	0.265	0.548	13.5	A	B
DWC-032D-7						0.875	0.287	0.588	12.6	A	B
DWC-032D-7.5	0.938	0.313	0.625	11.0	A	B					

COMPRESSION SPRINGS

Note: Wire Dia. up to .098" is Music Wire (MW); .105" and over is Oil Tempered Wire (OT). Stainless available up to .135" wire size. Above rates and loads are multiplied by .833 when using stainless. For prices from 1 to 100 see Price Index. Please inquire if you need a size not listed above.

STOCK COMPRESSION SPRINGS

Music Wire/Oil Tempered & Stainless (See Below)

Ends Squared and Ground Ends to be Square Within 3 Degrees of Axis

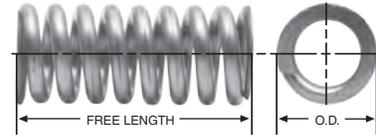

COMPRESSION SPRINGS

DIAMOND WIRE SPRING STOCK NO.	OUTSIDE DIAMETER	TO WORK IN HOLE DIA.	TO WORK OVER ROD DIA.	WIRE DIA.	APPROX. LOAD AT SOLID HT.	FREE LENGTH	SOLID HT.	TOTAL DEFLECTION	SPRING RATE	PRICE GROUP	
	IN.	IN.	IN.	IN.	LB.	IN.	IN.	IN.	LB./IN.	OT/MW	SS
DWC-032D-8	0.300	0.313	0.218	0.032	7.287	1.000	0.326	0.674	10.6	A	B
DWC-032D-9						1.250	0.388	0.862	8.6	A	B
DWC-032D-10						1.500	0.450	1.050	7.1	A	B
DWC-032D-11						1.750	0.518	1.232	6.0	B	C
DWC-032D-12						2.000	0.572	1.428	5.3	B	C
DWC-032D-12.5						2.250	0.635	1.615	4.7	B	C
DWC-032D-13						2.500	0.700	1.800	4.1	B	C
DWC-035D-4.5	0.300	0.313	0.221	0.035	9.590	0.563	0.226	0.336	28.4	A	B
DWC-035D-5.5						0.688	0.265	0.422	22.7	A	B
DWC-035D-6.5						0.813	0.304	0.508	18.9	A	B
DWC-035D-7.5						0.938	0.343	0.594	16.1	A	B
DWC-035D-8.5						1.125	0.401	0.724	13.3	A	B
DWC-035D-9.5						1.375	0.479	0.896	10.7	A	B
DWC-035D-11						1.750	0.596	1.154	8.3	B	C
DWC-035D-12						2.000	0.674	1.326	7.2	B	C
DWC-035D-12.5						2.250	0.752	1.498	6.4	B	C
DWC-035D-13						2.500	0.830	1.670	5.8	B	C
DWC-038D-2	0.300	0.313	0.215	0.038	12.134	0.375	0.197	0.178	64.5	A	B
DWC-038D-3						0.437	0.218	0.219	53.5	A	B
DWC-038D-4						0.500	0.237	0.263	46.4	A	B
DWC-038D-4.5						0.563	0.248	0.315	39.0	A	B
DWC-038D-5						0.625	0.284	0.341	34.9	A	B
DWC-038D-5.5						0.688	0.296	0.392	30.0	A	B
DWC-038D-6						0.750	0.331	0.419	27.9	A	B
DWC-038D-6.5						0.813	0.334	0.479	26.0	A	B
DWC-038D-7						0.875	0.379	0.496	23.2	A	B
DWC-038D-7.5						0.938	0.381	0.557	22.0	A	B
DWC-038D-8						1.000	0.417	0.583	20.5	A	B
DWC-038D-8.5						1.125	0.428	0.697	19.0	A	B
DWC-038D-9						1.250	0.493	0.757	16.6	A	B
DWC-038D-9.5						1.375	0.533	0.842	15.0	A	B
DWC-038D-10						1.500	0.570	0.930	13.9	A	B
DWC-038D-11						1.750	0.662	1.088	11.3	B	C
DWC-038D-12	2.000	0.772	1.228	9.5	B	C					
DWC-038D-12.5	2.250	0.858	1.392	8.6	B	C					
DWC-038D-13	2.500	0.944	1.556	7.7	B	C					
DWC-040D-2	0.300	0.313	0.203	0.040	13.509	0.375	0.231	0.144	75.5	A	B
DWC-040D-3						0.437	0.253	0.184	62.9	A	B
DWC-040D-4						0.500	0.275	0.225	53.9	A	B
DWC-040D-4.5						0.563	0.262	0.301	49.0	A	B
DWC-040D-5						0.625	0.320	0.305	41.9	A	B
DWC-040D-5.5						0.688	0.314	0.374	39.0	A	B
DWC-040D-6						0.750	0.368	0.382	33.8	A	B
DWC-040D-6.5						0.813	0.366	0.447	32.0	A	B
DWC-040D-7						0.875	0.416	0.459	28.3	A	B
DWC-040D-7.5						0.938	0.400	0.538	28.0	A	B
DWC-040D-8	1.000	0.460	0.540	24.6	A	B					

Note: Wire Dia. up to .098" is Music Wire (MW); .105" and over is Oil Tempered Wire (OT). Stainless available up to .135" wire size. Above rates and loads are multiplied by .833 when using stainless. For prices from 1 to 100 see Price Index. Please inquire if you need a size not listed above.

STOCK COMPRESSION SPRINGS

Music Wire/Oil Tempered & Stainless (See Below)

Ends Squared and Ground Ends to be Square Within 3 Degrees of Axis

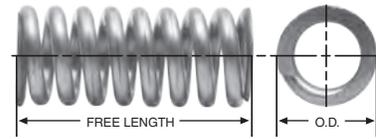

DIAMOND WIRE SPRING STOCK NO.	OUTSIDE DIAMETER	TO WORK IN HOLE DIA.	TO WORK OVER ROD DIA.	WIRE DIA.	APPROX. LOAD AT SOLID HT.	FREE LENGTH	SOLID HT.	TOTAL DEFLECTION	SPRING RATE	PRICE GROUP	
	IN.	IN.	IN.	IN.	LB.	IN.	IN.	IN.	LB./IN.	OT/MW	SS
DWC-040D-8.5	0.300	0.313	0.203	0.040	13.509	1.125	0.474	0.651	23.0	A	B
DWC-040D-9						1.250	0.553	0.697	19.4	A	B
DWC-040D-9.5						1.375	0.550	0.825	18.0	A	B
DWC-040D-10						1.500	0.645	0.855	16.0	A	B
DWC-040D-11						1.750	0.690	1.060	14.0	B	C
DWC-040D-12						2.000	0.810	1.190	12.0	B	C
DWC-040D-12.5						2.250	0.907	1.343	10.7	B	C
DWC-040D-13						2.500	1.000	1.500	9.6	B	C
DWC-042D-2	0.300	0.313	0.203	0.042	16.634	0.375	0.210	0.165	108.3	A	B
DWC-042D-3						0.437	0.230	0.207	90.8	A	B
DWC-042D-4						0.500	0.266	0.234	70.7	A	B
DWC-042D-4.5						0.563	0.285	0.278	60.0	A	B
DWC-042D-5						0.625	0.325	0.300	51.6	A	B
DWC-042D-5.5						0.688	0.337	0.351	46.0	A	B
DWC-042D-6						0.750	0.378	0.372	41.7	A	B
DWC-042D-6.5						0.813	0.390	0.423	38.0	A	B
DWC-042D-7						0.875	0.442	0.433	33.8	A	B
DWC-042D-7.5						0.938	0.452	0.486	32.0	A	B
DWC-042D-8						1.000	0.484	0.516	30.1	A	B
DWC-042D-8.5						1.125	0.506	0.619	28.0	A	B
DWC-042D-9						1.250	0.578	0.672	24.1	A	B
DWC-042D-9.5						1.375	0.631	0.744	22.0	A	B
DWC-042D-10						1.500	0.684	0.816	19.7	A	B
DWC-042D-11						1.750	0.786	0.964	16.5	B	C
DWC-042D-12	2.000	0.884	1.116	14.5	B	C					
DWC-042D-12.5	2.250	0.995	1.255	13.0	B	C					
DWC-042D-13	2.500	1.079	1.421	11.6	B	C					
DWC-045D-2	0.300	0.313	0.187	0.045	18.901	0.375	0.247	0.128	123.5	A	B
DWC-045D-3						0.437	0.269	0.168	106.1	A	B
DWC-045D-4						0.500	0.292	0.208	92.6	A	B
DWC-045D-4.5						0.563	0.316	0.247	77.0	A	B
DWC-045D-5						0.625	0.359	0.266	67.6	A	B
DWC-045D-5.5						0.688	0.372	0.316	61.0	A	B
DWC-045D-6						0.750	0.415	0.335	55.0	A	B
DWC-045D-6.5						0.813	0.417	0.396	51.0	A	B
DWC-045D-7						0.875	0.472	0.403	46.4	A	B
DWC-045D-7.5						0.938	0.496	0.442	42.0	A	B
DWC-045D-8						1.000	0.527	0.473	40.2	A	B
DWC-045D-8.5						1.125	0.564	0.561	36.0	A	B
DWC-045D-9						1.250	0.629	0.621	32.3	A	B
DWC-045D-9.5						1.375	0.664	0.711	29.0	A	B
DWC-045D-10						1.500	0.742	0.758	26.5	A	B
DWC-045D-11						1.750	0.860	0.890	22.0	B	C
DWC-045D-12	2.000	0.960	1.040	19.0	B	C					
DWC-045D-12.5	2.250	1.080	1.170	17.0	B	C					
DWC-045D-13	2.500	1.191	1.309	15.3	B	C					

COMPRESSION SPRINGS

Note: Wire Dia. up to .098" is Music Wire (MW); .105" and over is Oil Tempered Wire (OT). Stainless available up to .135" wire size. Above rates and loads are multiplied by .833 when using stainless. For prices from 1 to 100 see Price Index. Please inquire if you need a size not listed above.

STOCK COMPRESSION SPRINGS

Music Wire/Oil Tempered & Stainless (See Below)

Ends Squared and Ground Ends to be Square Within 3 Degrees of Axis

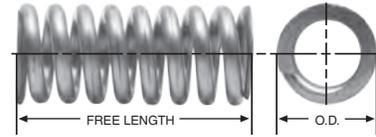

COMPRESSION SPRINGS

DIAMOND WIRE SPRING STOCK NO.	OUTSIDE DIAMETER	TO WORK IN HOLE DIA.	TO WORK OVER ROD DIA.	WIRE DIA.	APPROX. LOAD AT SOLID HT.	FREE LENGTH	SOLID HT.	TOTAL DEFLECTION	SPRING RATE	PRICE GROUP	
	IN.	IN.	IN.	IN.	LB.	IN.	IN.	IN.	LB./IN.	OT/MW	SS
DWC-047D-2	0.300	0.313	0.197	0.047	23.423	0.375	0.234	0.141	159.1	A	B
DWC-047D-3						0.438	0.262	0.176	132.3	A	B
DWC-047D-4						0.500	0.292	0.208	112.1	A	B
DWC-047D-4.5						0.562	0.322	0.240	97.2	A	B
DWC-047D-5						0.625	0.352	0.273	85.7	A	B
DWC-047D-5.5						0.687	0.382	0.305	76.7	A	B
DWC-047D-6						0.750	0.412	0.338	69.3	A	B
DWC-047D-6.5						0.812	0.442	0.370	63.3	A	B
DWC-047D-7						0.875	0.472	0.403	58.2	A	B
DWC-047D-7.5						0.937	0.502	0.435	54.0	A	B
DWC-047D-8						1.000	0.533	0.467	50.2	A	B
DWC-047D-8.5						1.125	0.593	0.532	44.1	A	B
DWC-047D-9						1.250	0.653	0.597	39.4	A	B
DWC-047D-9.5						1.375	0.713	0.662	35.5	A	B
DWC-047D-10						1.500	0.773	0.727	32.4	A	B
DWC-047D-11						1.750	0.893	0.857	27.5	B	C
DWC-047D-12	2.000	1.013	0.987	23.9	B	C					
DWC-047D-12.5	2.250	1.134	1.116	21.1	B	C					
DWC-047D-13	2.500	1.254	1.246	18.9	B	C					
DWC-047D-13.5	2.750	1.376	1.374	17.1	B	C					
DWC-047D-14	3.000	1.490	1.510	15.7	B	C					
DWC-049D-2	0.300	0.313	0.193	0.049	25.772	0.375	0.244	0.131	193.4	A	B
DWC-049D-3						0.438	0.276	0.162	157.6	A	B
DWC-049D-4						0.500	0.308	0.192	133.3	A	B
DWC-049D-4.5						0.562	0.340	0.222	115.4	A	B
DWC-049D-5						0.625	0.372	0.253	101.6	A	B
DWC-049D-5.5						0.687	0.404	0.283	91.0	A	B
DWC-049D-6						0.750	0.437	0.313	82.2	B	C
DWC-049D-6.5						0.812	0.469	0.343	75.1	B	C
DWC-049D-7						0.875	0.501	0.374	69.0	B	C
DWC-049D-7.5						0.937	0.533	0.404	63.9	B	C
DWC-049D-8						1.000	0.565	0.435	59.4	B	C
DWC-049D-8.5						1.125	0.630	0.495	52.2	B	C
DWC-049D-9						1.250	0.694	0.556	46.5	B	C
DWC-049D-9.5						1.375	0.759	0.616	42.0	B	C
DWC-049D-10						1.500	0.823	0.677	38.2	B	C
DWC-049D-11						1.750	0.952	0.798	32.4	C	D
DWC-049D-12	2.000	1.080	0.920	28.2	C	D					
DWC-049D-12.5	2.250	1.209	1.041	24.9	C	D					
DWC-049D-13	2.500	1.338	1.162	22.3	C	D					
DWC-049D-13.5	2.750	1.467	1.283	20.2	C	D					
DWC-049D-14	3.000	1.601	1.399	18.4	D	E					
DWC-051D-2	0.300	0.313	0.189	0.051	27.977	0.375	0.255	0.120	229.9	A	B
DWC-051D-3						0.438	0.290	0.148	186.8	A	B
DWC-051D-4						0.500	0.324	0.176	157.7	A	B
DWC-051D-4.5						0.562	0.358	0.204	136.5	A	B
DWC-051D-5						0.625	0.393	0.232	120.0	A	B

Note: Wire Dia. up to .098" is Music Wire (MW); .105" and over is Oil Tempered Wire (OT). Stainless available up to .135" wire size. Above rates and loads are multiplied by .833 when using stainless. For prices from 1 to 100 see Price Index. Please inquire if you need a size not listed above.

STOCK COMPRESSION SPRINGS

Music Wire/Oil Tempered & Stainless (See Below)

Ends Squared and Ground Ends to be Square Within 3 Degrees of Axis

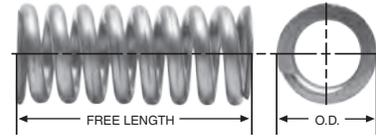

DIAMOND WIRE SPRING STOCK NO.	OUTSIDE DIAMETER	TO WORK IN HOLE DIA.	TO WORK OVER ROD DIA.	WIRE DIA.	APPROX. LOAD AT SOLID HT.	FREE LENGTH	SOLID HT.	TOTAL DEFLECTION	SPRING RATE	PRICE GROUP	
	IN.	IN.	IN.	IN.	LB.	IN.	IN.	IN.	LB./IN.	OT/MW	SS
DWC-051D-5.5	0.300	0.313	0.189	0.051	27.977	0.687	0.427	0.260	107.3	A	B
DWC-051D-6						0.750	0.461	0.289	96.9	B	C
DWC-051D-6.5						0.812	0.496	0.316	88.4	B	C
DWC-051D-7						0.875	0.530	0.345	81.2	B	C
DWC-051D-7.5						0.937	0.564	0.373	75.2	B	C
DWC-051D-8						1.000	0.599	0.401	69.9	B	C
DWC-051D-8.5						1.125	0.668	0.457	61.4	B	C
DWC-051D-9						1.250	0.737	0.513	54.7	B	C
DWC-051D-9.5						1.375	0.805	0.570	49.3	B	C
DWC-051D-10						1.500	0.874	0.626	44.9	B	C
DWC-051D-11						1.750	1.011	0.739	38.1	C	D
DWC-051D-12						2.000	1.149	0.851	33.1	C	D
DWC-051D-12.5						2.250	1.287	0.963	29.2	C	D
DWC-051D-13	2.500	1.424	1.076	26.2	C	D					
DWC-016DE-1	0.312	0.328	0.266	0.016	0.553	0.250	0.054	0.196	2.8	A	B
DWC-016DE-1.5						0.312	0.061	0.251	2.2	A	B
DWC-016DE-2						0.375	0.067	0.308	1.8	A	B
DWC-016DE-3						0.438	0.073	0.365	1.5	A	B
DWC-016DE-4						0.500	0.080	0.420	1.3	A	B
DWC-016DE-4.5						0.562	0.086	0.476	1.2	A	B
DWC-016DE-5						0.625	0.092	0.533	1.0	A	B
DWC-016DE-5.5						0.687	0.099	0.588	0.9	A	B
DWC-016DE-6						0.750	0.105	0.645	0.9	A	B
DWC-016DE-6.5						0.812	0.111	0.701	0.8	A	B
DWC-016DE-7						0.875	0.118	0.757	0.7	A	B
DWC-016DE-7.5						0.937	0.124	0.813	0.7	A	B
DWC-016DE-8						1.000	0.130	0.870	0.6	A	B
DWC-016DE-9						1.250	0.155	1.095	0.5	C	D
DWC-016DE-10						1.500	0.181	1.319	0.4	D	E
DWC-016DE-11	1.750	0.206	1.544	0.4	D	E					
DWC-016DE-12	2.000	0.231	1.769	0.3	D	E					
DWC-023DE-2	0.312	0.328	0.255	0.023	2.423	0.375	0.131	0.244	4.9	A	B
DWC-023DE-3						0.438	0.147	0.291	4.1	A	B
DWC-023DE-4						0.500	0.163	0.337	3.6	A	B
DWC-023DE-4.5						0.563	0.179	0.384	3.1	A	B
DWC-023DE-5						0.625	0.195	0.430	2.8	A	B
DWC-023DE-5.5						0.688	0.211	0.477	2.5	A	B
DWC-023DE-6						0.750	0.227	0.523	2.3	A	B
DWC-023DE-6.5						0.813	0.243	0.570	2.1	A	B
DWC-023DE-7						0.875	0.258	0.617	1.9	A	B
DWC-023DE-7.5						0.938	0.275	0.663	1.8	A	B
DWC-023DE-8						1.000	0.290	0.710	1.7	A	B
DWC-023DE-9						1.250	0.354	0.896	1.3	A	B
DWC-023DE-9.5						1.375	0.386	0.989	1.2	A	B
DWC-023DE-10						1.500	0.418	1.082	1.1	A	B
DWC-023DE-11						1.750	0.482	1.268	0.9	B	C
DWC-023DE-12	2.000	0.546	1.454	0.8	B	C					

COMPRESSION SPRINGS

Note: Wire Dia. up to .098" is Music Wire (MW); .105" and over is Oil Tempered Wire (OT). Stainless available up to .135" wire size. Above rates and loads are multiplied by .833 when using stainless. For prices from 1 to 100 see Price Index. Please inquire if you need a size not listed above.

STOCK COMPRESSION SPRINGS

Music Wire/Oil Tempered & Stainless (See Below)

Ends Squared and Ground Ends to be Square Within 3 Degrees of Axis

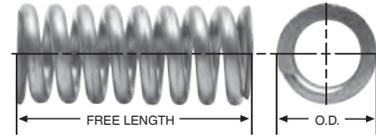

COMPRESSION SPRINGS

DIAMOND WIRE SPRING STOCK NO.	OUTSIDE DIAMETER	TO WORK IN HOLE DIA.	TO WORK OVER ROD DIA.	WIRE DIA.	APPROX. LOAD AT SOLID HT.	FREE LENGTH	SOLID HT.	TOTAL DEFLECTION	SPRING RATE	PRICE GROUP	
	IN.	IN.	IN.	IN.	LB.	IN.	IN.	IN.	LB./IN.	OT/MW	SS
DWC-023DE-12.5	0.312	0.328	0.255	0.023	2.423	2.250	0.609	1.641	0.7	B	C
DWC-023DE-13						2.500	0.673	1.827	0.7	B	C
DWC-026DE-3	0.312	0.328	0.248	0.026	2.423	0.438	0.147	0.291	8.3	A	B
DWC-026DE-4						0.500	0.162	0.338	7.2	A	B
DWC-026DE-4.5						0.563	0.178	0.385	6.3	A	B
DWC-026DE-5						0.625	0.193	0.432	5.6	A	B
DWC-026DE-5.5						0.688	0.208	0.480	5.1	A	B
DWC-026DE-6						0.750	0.223	0.527	4.6	A	B
DWC-026DE-6.5						0.813	0.239	0.574	4.2	A	B
DWC-026DE-7						0.875	0.254	0.621	3.9	A	B
DWC-026DE-7.5						0.938	0.269	0.669	3.6	A	B
DWC-026DE-8						1.000	0.284	0.716	3.4	A	B
DWC-026DE-9						1.250	0.345	0.905	2.7	A	B
DWC-026DE-10						1.500	0.407	1.093	2.2	A	B
DWC-026DE-11						1.750	0.468	1.282	1.9	A	B
DWC-026DE-12	2.000	0.529	1.471	1.7	A	B					
DWC-026DE-12.5	2.250	0.590	1.660	1.5	B	C					
DWC-026DE-13	2.500	0.651	1.849	1.3	B	C					
DWC-047DE-2	0.312	0.328	0.208	0.047	13.511	0.375	0.260	0.115	116.1	A	B
DWC-047DE-3						0.438	0.297	0.141	94.9	A	B
DWC-047DE-4						0.500	0.333	0.167	80.4	A	B
DWC-047DE-4.5						0.562	0.369	0.193	69.8	A	B
DWC-047DE-5						0.625	0.406	0.219	61.5	A	B
DWC-047DE-5.5						0.687	0.442	0.245	55.1	A	B
DWC-047DE-6						0.750	0.479	0.271	49.8	A	B
DWC-047DE-6.5						0.812	0.515	0.297	45.5	A	B
DWC-047DE-7						0.875	0.552	0.323	41.8	A	B
DWC-047DE-7.5						0.937	0.588	0.349	38.7	A	B
DWC-047DE-8						1.000	0.625	0.375	36.0	A	B
DWC-047DE-8.5						1.125	0.698	0.427	31.7	A	B
DWC-047DE-9						1.250	0.770	0.480	28.2	A	B
DWC-047DE-9.5						1.375	0.843	0.532	25.5	A	B
DWC-047DE-10						1.500	0.916	0.584	23.2	A	B
DWC-047DE-11						1.750	1.062	0.688	19.7	A	B
DWC-047DE-12	2.000	1.208	0.792	17.1	A	B					
DWC-047DE-12.5	2.250	1.354	0.896	15.1	B	C					
DWC-047DE-13	2.500	1.499	1.001	13.6	B	C					
DWC-047DE-13.5	2.750	1.645	1.105	12.3	C	D					
DWC-047DE-14	3.000	1.791	1.209	11.2	D	E					
DWC-026E-4	0.360	0.375	0.281	0.026	3.523	0.500	0.117	0.383	9.2	A	B
DWC-026E-4.5						0.563	0.115	0.448	8.0	A	B
DWC-026E-5						0.625	0.129	0.496	7.4	A	B
DWC-026E-5.5						0.688	0.131	0.557	6.5	A	B
DWC-026E-6						0.750	0.143	0.607	6.1	A	B
DWC-026E-6.5						0.813	0.144	0.669	5.5	A	B
DWC-026E-7						0.875	0.162	0.713	4.9	A	B
DWC-026E-7.5	0.938	0.157	0.781	4.5	A	B					

Note: Wire Dia. up to .098" is Music Wire (MW); .105" and over is Oil Tempered Wire (OT). Stainless available up to .135" wire size. Above rates and loads are multiplied by .833 when using stainless. For prices from 1 to 100 see Price Index. Please inquire if you need a size not listed above.

STOCK COMPRESSION SPRINGS

Music Wire/Oil Tempered & Stainless (See Below)

Ends Squared and Ground Ends to be Square Within 3 Degrees of Axis

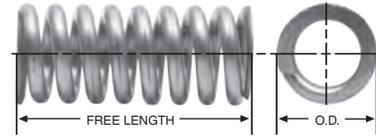

DIAMOND WIRE SPRING STOCK NO.	OUTSIDE DIAMETER	TO WORK IN HOLE DIA.	TO WORK OVER ROD DIA.	WIRE DIA.	APPROX. LOAD AT SOLID HT.	FREE LENGTH	SOLID HT.	TOTAL DEFLECTION	SPRING RATE	PRICE GROUP	
	IN.	IN.	IN.	IN.	LB.	IN.	IN.	IN.	LB./IN.	OT/MW	SS
DWC-026E-8	0.360	0.375	0.281	0.026	3.523	1.000	0.181	0.819	4.1	A	B
DWC-026E-8.5						1.125	0.190	0.935	3.5	A	B
DWC-026E-9						1.250	0.213	1.037	3.4	A	B
DWC-026E-10						1.500	0.242	1.258	2.8	A	B
DWC-026E-11						1.750	0.270	1.480	2.4	A	B
DWC-026E-12						2.000	0.298	1.702	2.1	A	B
DWC-026E-12.5						2.250	0.317	1.933	1.9	B	C
DWC-029E-4	0.360	0.375	0.281	0.029	4.460	0.500	0.150	0.350	12.9	A	B
DWC-029E-4.5						0.563	0.151	0.412	10.7	A	B
DWC-029E-5						0.625	0.167	0.458	10.2	A	B
DWC-029E-5.5						0.688	0.171	0.517	8.6	A	B
DWC-029E-6						0.750	0.186	0.564	8.2	A	B
DWC-029E-6.5						0.813	0.192	0.621	7.0	A	B
DWC-029E-7						0.875	0.204	0.671	6.9	A	B
DWC-029E-7.5						0.938	0.213	0.725	6.1	A	B
DWC-029E-8						1.000	0.221	0.779	6.1	A	B
DWC-029E-8.5						1.125	0.242	0.883	5.0	A	B
DWC-029E-9						1.250	0.257	0.993	4.8	A	B
DWC-029E-9.5						1.375	0.283	1.092	4.0	A	B
DWC-029E-10						1.500	0.292	1.208	4.0	A	B
DWC-029E-11						1.750	0.328	1.422	3.4	A	B
DWC-029E-12	2.000	0.364	1.636	2.9	B	C					
DWC-032E-2	0.360	0.375	0.281	0.032	6.137	0.375	0.151	0.224	24.8	A	B
DWC-032E-3						0.437	0.162	0.275	20.8	A	B
DWC-032E-4						0.500	0.159	0.341	17.9	A	B
DWC-032E-4.5						0.563	0.161	0.402	16.0	A	B
DWC-032E-5						0.625	0.175	0.450	14.9	A	B
DWC-032E-5.5						0.688	0.177	0.511	13.0	A	B
DWC-032E-6						0.750	0.199	0.551	11.9	A	B
DWC-032E-6.5						0.813	0.201	0.612	11.0	A	B
DWC-032E-7						0.875	0.224	0.651	9.9	A	B
DWC-032E-7.5						0.938	0.225	0.713	9.5	A	B
DWC-032E-8						1.000	0.247	0.753	8.5	A	B
DWC-032E-8.5						1.125	0.265	0.860	7.5	A	B
DWC-032E-9						1.250	0.303	0.947	6.6	A	B
DWC-032E-9.5						1.375	0.297	1.078	6.5	A	B
DWC-032E-10						1.500	0.344	1.156	5.4	A	B
DWC-032E-11						1.750	0.391	1.359	4.6	A	B
DWC-032E-12	2.000	0.434	1.566	4.0	A	B					
DWC-032E-12.5	2.250	0.471	1.779	3.6	B	C					
DWC-032E-13	2.500	0.514	1.986	3.2	B	C					
DWC-035E-3	0.360	0.375	0.266	0.035	7.537	0.437	0.182	0.255	28.4	A	B
DWC-035E-4						0.500	0.195	0.305	24.4	A	B
DWC-035E-4.5						0.563	0.194	0.369	20.3	A	B
DWC-035E-5						0.625	0.220	0.405	19.1	A	B
DWC-035E-5.5						0.688	0.223	0.465	16.0	A	B
DWC-035E-6						0.750	0.247	0.503	15.4	A	B

Note: Wire Dia. up to .098" is Music Wire (MW); .105" and over is Oil Tempered Wire (OT). Stainless available up to .135" wire size. Above rates and loads are multiplied by .833 when using stainless. For prices from 1 to 100 see Price Index. Please inquire if you need a size not listed above.

STOCK COMPRESSION SPRINGS

Music Wire/Oil Tempered & Stainless (See Below)

Ends Squared and Ground Ends to be Square Within 3 Degrees of Axis

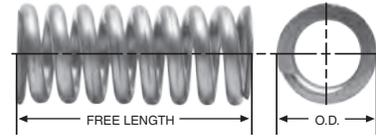

COMPRESSION SPRINGS

DIAMOND WIRE SPRING STOCK NO.	OUTSIDE DIAMETER	TO WORK IN HOLE DIA.	TO WORK OVER ROD DIA.	WIRE DIA.	APPROX. LOAD AT SOLID HT.	FREE LENGTH	SOLID HT.	TOTAL DEFLECTION	SPRING RATE	PRICE GROUP	
	IN.	IN.	IN.	IN.	LB.	IN.	IN.	IN.	LB./IN.	OT/MW	SS
DWC-035E-6.5	0.360	0.375	0.266	0.035	7.537	0.813	0.252	0.561	13.3	A	B
DWC-035E-7						0.875	0.275	0.600	13.0	A	B
DWC-035E-7.5						0.938	0.279	0.659	11.7	A	B
DWC-035E-8						1.000	0.300	0.700	11.3	A	B
DWC-035E-8.5						1.125	0.325	0.800	9.5	A	B
DWC-035E-9						1.250	0.352	0.898	8.9	A	B
DWC-035E-9.5						1.375	0.381	0.994	7.7	A	B
DWC-035E-10						1.500	0.404	1.096	7.3	A	B
DWC-035E-11						1.750	0.457	1.293	6.3	B	C
DWC-035E-12						2.000	0.509	1.491	5.4	B	C
DWC-035E-12.5						2.250	0.580	1.670	4.6	B	C
DWC-035E-13						2.500	0.640	1.860	4.1	B	C
DWC-038E-3						0.360	0.375	0.266	0.038	9.769	0.437
DWC-038E-4	0.500	0.199	0.301	34.1	A						B
DWC-038E-4.5	0.563	0.200	0.363	28.0	A						B
DWC-038E-5	0.625	0.237	0.388	24.9	A						B
DWC-038E-5.5	0.688	0.239	0.449	22.0	A						B
DWC-038E-6	0.750	0.266	0.484	20.8	A						B
DWC-038E-6.5	0.813	0.267	0.546	19.0	A						B
DWC-038E-7	0.875	0.304	0.571	17.0	A						B
DWC-038E-7.5	0.938	0.305	0.633	16.0	A						B
DWC-038E-8	1.000	0.332	0.668	15.0	A						B
DWC-038E-8.5	1.125	0.352	0.773	13.0	A						B
DWC-038E-9	1.250	0.399	0.851	11.7	A						B
DWC-038E-9.5	1.375	0.438	0.937	10.0	A						B
DWC-038E-10	1.500	0.465	1.035	9.6	A						B
DWC-038E-11	1.750	0.526	1.224	8.3	B						C
DWC-038E-12	2.000	0.587	1.413	7.2	B						C
DWC-038E-12.5	2.250	0.632	1.618	6.5	B	C					
DWC-038E-13	2.500	0.714	1.786	5.8	B	C					
DWC-040E-3	0.360	0.375	0.250	0.040	10.927	0.437	0.218	0.219	46.0	A	B
DWC-040E-4						0.500	0.234	0.266	39.4	A	B
DWC-040E-4.5						0.563	0.234	0.329	33.0	A	B
DWC-040E-5						0.625	0.267	0.358	30.7	A	B
DWC-040E-5.5						0.688	0.270	0.418	26.2	A	B
DWC-040E-6						0.750	0.302	0.448	24.7	A	B
DWC-040E-6.5						0.813	0.306	0.507	22.2	A	B
DWC-040E-7						0.875	0.337	0.538	20.7	A	B
DWC-040E-7.5						0.938	0.342	0.596	18.8	A	B
DWC-040E-8						1.000	0.370	0.630	18.0	A	B
DWC-040E-8.5						1.125	0.398	0.727	15.4	A	B
DWC-040E-9						1.250	0.438	0.812	14.1	A	B
DWC-040E-9.5						1.375	0.475	0.900	12.4	A	B
DWC-040E-10						1.500	0.505	0.995	11.7	A	B
DWC-040E-11						1.750	0.573	1.177	9.9	A	B
DWC-040E-12						2.000	0.641	1.359	8.6	B	C

Note: Wire Dia. up to .098" is Music Wire (MW); .105" and over is Oil Tempered Wire (OT). Stainless available up to .135" wire size. Above rates and loads are multiplied by .833 when using stainless. For prices from 1 to 100 see Price Index. Please inquire if you need a size not listed above.

STOCK COMPRESSION SPRINGS

Music Wire/Oil Tempered & Stainless (See Below)

Ends Squared and Ground Ends to be Square Within 3 Degrees of Axis

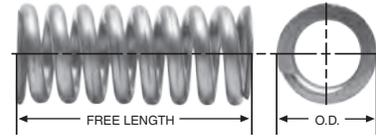

DIAMOND WIRE SPRING STOCK NO.	OUTSIDE DIAMETER	TO WORK IN HOLE DIA.	TO WORK OVER ROD DIA.	WIRE DIA.	APPROX. LOAD AT SOLID HT.	FREE LENGTH	SOLID HT.	TOTAL DEFLECTION	SPRING RATE	PRICE GROUP	
	IN.	IN.	IN.	IN.	LB.	IN.	IN.	IN.	LB./IN.	OT/MW	SS
DWC-040E-12.5	0.360	0.375	0.250	0.040	10.927	2.250	0.730	1.520	7.5	B	C
DWC-040E-13						2.500	0.810	1.690	6.6	B	C
DWC-042E-3	0.360	0.375	0.250	0.042	13.328	0.437	0.209	0.228	58.1	A	B
DWC-042E-4						0.500	0.231	0.269	48.3	A	B
DWC-042E-4.5						0.563	0.232	0.331	42.0	A	B
DWC-042E-5						0.625	0.262	0.363	38.6	A	B
DWC-042E-5.5						0.688	0.274	0.414	33.0	A	B
DWC-042E-6						0.750	0.301	0.449	30.9	A	B
DWC-042E-6.5						0.813	0.306	0.507	28.0	A	B
DWC-042E-7						0.875	0.346	0.529	25.2	A	B
DWC-042E-7.5						0.938	0.359	0.579	23.0	A	B
DWC-042E-8						1.000	0.388	0.612	21.5	A	B
DWC-042E-8.5						1.125	0.411	0.714	19.0	A	B
DWC-042E-9						1.250	0.463	0.787	17.0	A	B
DWC-042E-9.5						1.375	0.485	0.890	16.0	A	B
DWC-042E-10						1.500	0.525	0.975	14.5	A	B
DWC-042E-11						1.750	0.621	1.129	11.8	B	C
DWC-042E-12						2.000	0.695	1.305	10.3	B	C
DWC-042E-12.5	2.250	0.769	1.481	9.0	B	C					
DWC-042E-13	2.500	0.850	1.650	8.3	B	C					
DWC-045E-3	0.360	0.375	0.250	0.045	16.353	0.437	0.224	0.213	79.0	A	B
DWC-045E-4						0.500	0.247	0.253	65.7	A	B
DWC-045E-4.5						0.563	0.260	0.303	55.0	A	B
DWC-045E-5						0.625	0.292	0.333	49.1	A	B
DWC-045E-5.5						0.688	0.294	0.394	44.0	A	B
DWC-045E-6						0.750	0.337	0.413	39.4	A	B
DWC-045E-6.5						0.813	0.339	0.474	37.0	A	B
DWC-045E-7						0.875	0.382	0.493	32.8	A	B
DWC-045E-7.5						0.938	0.395	0.543	30.0	A	B
DWC-045E-8						1.000	0.427	0.573	28.1	A	B
DWC-045E-8.5						1.125	0.451	0.674	25.0	A	B
DWC-045E-9						1.250	0.516	0.734	21.9	A	B
DWC-045E-9.5						1.375	0.541	0.834	20.0	A	B
DWC-045E-10						1.500	0.607	0.893	17.9	A	B
DWC-045E-11						1.750	0.694	1.056	15.2	B	C
DWC-045E-12						2.000	0.778	1.222	13.2	B	C
DWC-045E-12.5	2.250	0.851	1.399	11.8	B	C					
DWC-045E-13	2.500	0.945	1.555	10.6	B	C					
DWC-045E-13.5	2.750	1.045	1.705	9.4	B	C					
DWC-047E-3	0.360	0.375	0.261	0.045	20.138	0.438	0.221	0.217	93.0	A	B
DWC-047E-4						0.500	0.243	0.257	78.8	A	B
DWC-047E-4.5						0.563	0.266	0.297	68.2	A	B
DWC-047E-5						0.625	0.289	0.336	60.2	A	B
DWC-047E-5.5						0.688	0.311	0.377	53.8	A	B
DWC-047E-6						0.750	0.334	0.416	48.8	A	B
DWC-047E-6.5						0.813	0.357	0.456	44.5	A	B
DWC-047E-7	0.875	0.379	0.496	41.0	A	B					

COMPRESSION SPRINGS

Note: Wire Dia. up to .098" is Music Wire (MW); .105" and over is Oil Tempered Wire (OT). Stainless available up to .135" wire size. Above rates and loads are multiplied by .833 when using stainless. For prices from 1 to 100 see Price Index. Please inquire if you need a size not listed above.

STOCK COMPRESSION SPRINGS

Music Wire/Oil Tempered & Stainless (See Below)

Ends Squared and Ground Ends to be Square Within 3 Degrees of Axis

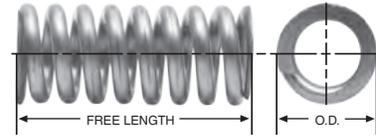

COMPRESSION SPRINGS

DIAMOND WIRE SPRING STOCK NO.	OUTSIDE DIAMETER	TO WORK IN HOLE DIA.	TO WORK OVER ROD DIA.	WIRE DIA.	APPROX. LOAD AT SOLID HT.	FREE LENGTH	SOLID HT.	TOTAL DEFLECTION	SPRING RATE	PRICE GROUP	
	IN.	IN.	IN.	IN.	LB.	IN.	IN.	IN.	LB./IN.	OT/MW	SS
DWC-047E-7.5	0.360	0.375	0.261	0.045	20.138	0.938	0.402	0.536	37.9	A	B
DWC-047E-8						1.000	0.424	0.576	35.3	A	B
DWC-047E-8.5						1.125	0.469	0.656	31.0	A	B
DWC-047E-9						1.250	0.514	0.736	27.7	B	C
DWC-047E-9.5						1.375	0.560	0.815	25.0	B	C
DWC-047E-10						1.500	0.605	0.895	22.7	B	C
DWC-047E-11						1.750	0.695	1.055	19.3	B	C
DWC-047E-12						2.000	0.785	1.215	16.8	C	D
DWC-047E-12.5						2.250	0.876	1.374	14.8	C	D
DWC-047E-13						2.500	0.966	1.534	13.3	D	E
DWC-047E-13.5						2.750	1.056	1.694	12.0	D	E
DWC-047E-14						3.000	1.147	1.853	11.0	D	E
DWC-047E-14.5						3.250	1.241	2.009	10.1	D	E
DWC-047E-15						3.500	1.326	2.174	9.4	D	E
DWC-049E-3						0.360	0.375	0.253	0.049	22.481	0.438
DWC-049E-4	0.500	0.258	0.242	92.2	A						B
DWC-049E-4.5	0.563	0.282	0.281	79.9	A						B
DWC-049E-5	0.625	0.307	0.318	70.4	A						B
DWC-049E-5.5	0.688	0.331	0.357	62.9	A						B
DWC-049E-6	0.750	0.356	0.394	56.9	A						B
DWC-049E-6.5	0.813	0.380	0.433	52.0	A						B
DWC-049E-7	0.875	0.405	0.470	47.7	A						B
DWC-049E-8	1.000	0.454	0.546	41.1	A						B
DWC-049E-8.5	1.125	0.503	0.622	36.1	B						C
DWC-049E-9	1.250	0.552	0.698	32.2	B						C
DWC-049E-9.5	1.375	0.600	0.775	29.1	B						C
DWC-049E-10	1.500	0.650	0.850	26.4	B						C
DWC-049E-11	1.750	0.747	1.003	22.5	C						D
DWC-049E-12	2.000	0.845	1.155	19.5	C						D
DWC-049E-12.5	2.250	0.943	1.307	17.2	C	D					
DWC-049E-13	2.500	1.041	1.459	15.5	C	D					
DWC-049E-13.5	2.750	1.139	1.611	14.0	D	E					
DWC-049E-14	3.000	1.236	1.764	12.8	D	E					
DWC-049E-14.5	3.250	1.330	1.920	11.8	D	E					
DWC-049E-15	3.500	1.432	2.068	10.9	D	E					
DWC-051E-3	0.360	0.375	0.249	0.051	24.737	0.438	0.246	0.192	127.7	A	B
DWC-051E-4						0.500	0.272	0.228	107.8	A	B
DWC-051E-4.5						0.563	0.298	0.265	93.3	A	B
DWC-051E-5						0.625	0.325	0.300	82.1	A	B
DWC-051E-5.5						0.688	0.351	0.337	73.4	A	B
DWC-051E-6						0.750	0.377	0.373	66.2	A	B
DWC-051E-6.5						0.813	0.403	0.410	60.4	A	B
DWC-051E-7						0.875	0.430	0.445	55.5	A	B
DWC-051E-8						1.000	0.482	0.518	47.8	A	B
DWC-051E-8.5						1.125	0.535	0.590	42.0	B	C
DWC-051E-9						1.250	0.587	0.663	37.4	B	C
DWC-051E-9.5						1.375	0.640	0.735	33.7	B	C

Note: Wire Dia. up to .098" is Music Wire (MW); .105" and over is Oil Tempered Wire (OT). Stainless available up to .135" wire size. Above rates and loads are multiplied by .833 when using stainless. For prices from 1 to 100 see Price Index. Please inquire if you need a size not listed above.

STOCK COMPRESSION SPRINGS

Music Wire/Oil Tempered & Stainless (See Below)

Ends Squared and Ground Ends to be Square Within 3 Degrees of Axis

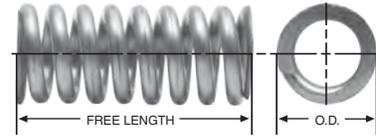

DIAMOND WIRE SPRING STOCK NO.	OUTSIDE DIAMETER	TO WORK IN HOLE DIA.	TO WORK OVER ROD DIA.	WIRE DIA.	APPROX. LOAD AT SOLID HT.	FREE LENGTH	SOLID HT.	TOTAL DEFLECTION	SPRING RATE	PRICE GROUP	
	IN.	IN.	IN.	IN.	LB.	IN.	IN.	IN.	LB./IN.	OT/MW	SS
DWC-051E-10	0.360	0.375	0.249	0.051	24.737	1.500	0.693	0.807	30.7	B	C
DWC-051E-11						1.750	0.798	0.952	26.0	C	D
DWC-051E-12						2.000	0.903	1.097	22.6	C	D
DWC-051E-12.5						2.250	1.008	1.242	20.0	C	D
DWC-051E-13						2.500	1.113	1.387	17.9	C	D
DWC-051E-13.5						2.750	1.218	1.532	16.2	D	E
DWC-051E-14						3.000	1.323	1.677	14.8	D	E
DWC-051E-14.5						3.250	1.434	1.816	13.6	D	E
DWC-051E-15	3.500	1.539	1.961	12.6	D	E					
DWC-055E-3	0.360	0.375	0.241	0.055	29.810	0.438	0.270	0.168	174.9	A	B
DWC-055E-4						0.500	0.300	0.200	147.0	A	B
DWC-055E-4.5						0.563	0.329	0.234	126.9	A	B
DWC-055E-5						0.625	0.359	0.266	111.4	A	B
DWC-055E-5.5						0.688	0.389	0.299	99.4	A	B
DWC-055E-6						0.750	0.419	0.331	89.6	A	B
DWC-055E-6.5						0.813	0.449	0.364	81.7	A	B
DWC-055E-7						0.875	0.479	0.396	75.0	A	B
DWC-055E-8						1.000	0.539	0.461	64.5	A	B
DWC-055E-8.5						1.125	0.598	0.527	56.5	B	C
DWC-055E-9						1.250	0.658	0.592	50.3	B	C
DWC-055E-9.5						1.375	0.718	0.657	45.4	B	C
DWC-055E-10						1.500	0.778	0.722	41.3	B	C
DWC-055E-11						1.750	0.897	0.853	35.0	C	D
DWC-055E-12						2.000	1.017	0.983	30.3	C	D
DWC-055E-12.5						2.250	1.136	1.114	26.8	C	D
DWC-055E-13						2.500	1.255	1.245	24.0	C	D
DWC-055E-13.5						2.750	1.375	1.375	21.7	D	E
DWC-055E-14	3.000	1.494	1.506	19.8	D	E					
DWC-055E-14.5	3.250	1.595	1.655	18.5	D	E					
DWC-055E-15	3.500	1.716	1.784	17.1	D	E					
DWC-059E-3	0.360	0.375	0.233	0.059	33.565	0.438	0.296	0.142	232.1	B	C
DWC-059E-4						0.500	0.329	0.171	194.5	B	C
DWC-059E-4.5						0.562	0.363	0.199	167.3	B	C
DWC-059E-5						0.625	0.397	0.228	146.5	B	C
DWC-059E-5.5						0.687	0.431	0.256	130.5	B	C
DWC-059E-6						0.750	0.465	0.285	117.5	B	C
DWC-059E-6.5						0.812	0.499	0.313	107.6	B	C
DWC-059E-7						0.875	0.533	0.342	98.2	B	C
DWC-059E-8						1.000	0.601	0.399	84.2	B	C
DWC-059E-8.5						1.125	0.669	0.456	73.8	C	D
DWC-059E-9						1.250	0.737	0.513	65.6	C	D
DWC-059E-9.5						1.375	0.805	0.570	59.1	C	D
DWC-059E-10						1.500	0.873	0.627	53.8	C	D
DWC-059E-11						1.750	1.009	0.741	45.5	C	D
DWC-059E-12						2.000	1.145	0.855	39.5	C	D
DWC-059E-12.5	2.250	1.281	0.969	34.9	D	E					
DWC-059E-13	2.500	1.417	1.083	31.2	D	E					

COMPRESSION SPRINGS

Note: Wire Dia. up to .098" is Music Wire (MW); .105" and over is Oil Tempered Wire (OT). Stainless available up to .135" wire size. Above rates and loads are multiplied by .833 when using stainless. For prices from 1 to 100 see Price Index. Please inquire if you need a size not listed above.

STOCK COMPRESSION SPRINGS

Music Wire/Oil Tempered & Stainless (See Below)

Ends Squared and Ground Ends to be Square Within 3 Degrees of Axis

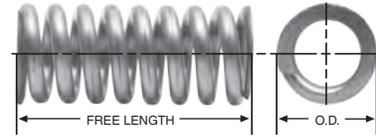

COMPRESSION SPRINGS

DIAMOND WIRE SPRING STOCK NO.	OUTSIDE DIAMETER	TO WORK IN HOLE DIA.	TO WORK OVER ROD DIA.	WIRE DIA.	APPROX. LOAD AT SOLID HT.	FREE LENGTH	SOLID HT.	TOTAL DEFLECTION	SPRING RATE	PRICE GROUP	
	IN.	IN.	IN.	IN.	LB.	IN.	IN.	IN.	LB./IN.	OT/MW	SS
DWC-059E-13.5	0.360	0.375	0.233	0.059	33.565	2.750	1.553	1.197	28.2	E	F
DWC-059E-14						3.000	1.689	1.311	25.8	E	F
DWC-059E-14.5						3.250	1.831	1.419	23.7	E	F
DWC-059E-15						3.500	1.979	1.521	21.8	E	F
DWC-026EE-4	0.375	0.390	0.309	0.026	2.356	0.500	0.122	0.378	6.2	A	B
DWC-026EE-4.5						0.563	0.132	0.431	5.5	A	B
DWC-026EE-5						0.625	0.142	0.483	4.9	A	B
DWC-026EE-5.5						0.688	0.151	0.537	4.4	A	B
DWC-026EE-6						0.750	0.161	0.589	4.0	A	B
DWC-026EE-6.5						0.813	0.171	0.642	3.7	A	B
DWC-026EE-7						0.875	0.180	0.695	3.4	A	B
DWC-026EE-7.5						0.938	0.190	0.748	3.2	A	B
DWC-026EE-8						1.000	0.200	0.800	2.9	A	B
DWC-026EE-8.5						1.125	0.219	0.906	2.6	A	B
DWC-026EE-9						1.250	0.238	1.012	2.3	A	B
DWC-026EE-10						1.500	0.277	1.223	1.9	A	B
DWC-026EE-11						1.750	0.315	1.435	1.6	A	B
DWC-026EE-12	2.000	0.354	1.646	1.4	A	B					
DWC-026EE-12.5	2.250	0.393	1.857	1.3	B	C					
DWC-032EE-2	0.375	0.390	0.299	0.032	3.826	0.375	0.143	0.232	16.5	A	B
DWC-032EE-4						0.500	0.175	0.325	11.8	A	B
DWC-032EE-4.5						0.563	0.191	0.372	10.3	A	B
DWC-032EE-5						0.625	0.206	0.419	9.1	A	B
DWC-032EE-5.5						0.688	0.222	0.466	8.2	A	B
DWC-032EE-6						0.750	0.237	0.513	7.5	A	B
DWC-032EE-6.5						0.813	0.253	0.560	6.8	A	B
DWC-032EE-7						0.875	0.269	0.606	6.3	A	B
DWC-032EE-7.5						0.938	0.285	0.653	5.9	A	B
DWC-032EE-8						1.000	0.300	0.700	5.5	A	B
DWC-032EE-8.5						1.125	0.331	0.794	4.8	A	B
DWC-032EE-9						1.250	0.363	0.887	4.3	A	B
DWC-032EE-9.5						1.375	0.394	0.981	3.9	A	B
DWC-032EE-10						1.500	0.425	1.075	3.6	A	B
DWC-032EE-11						1.750	0.488	1.262	3.0	A	B
DWC-032EE-12	2.000	0.551	1.449	2.6	B	C					
DWC-032EE-12.5	2.250	0.613	1.637	2.3	B	C					
DWC-032EE-13	2.500	0.676	1.824	2.1	B	C					
DWC-035EE-3	0.375	0.390	0.294	0.035	4.506	0.438	0.187	0.251	17.9	A	B
DWC-035EE-4						0.500	0.206	0.294	15.3	A	B
DWC-035EE-4.5						0.563	0.226	0.337	13.4	A	B
DWC-035EE-5						0.625	0.246	0.379	11.9	A	B
DWC-035EE-5.5						0.688	0.265	0.423	10.7	A	B
DWC-035EE-6						0.750	0.285	0.465	9.7	A	B
DWC-035EE-6.5						0.813	0.305	0.508	8.9	A	B
DWC-035EE-7						0.875	0.324	0.551	8.2	A	B
DWC-035EE-7.5	0.938	0.344	0.594	7.6	A	B					
DWC-035EE-8	1.000	0.363	0.637	7.1	A	B					

Note: Wire Dia. up to .098" is Music Wire (MW); .105" and over is Oil Tempered Wire (OT). Stainless available up to .135" wire size. Above rates and loads are multiplied by .833 when using stainless. For prices from 1 to 100 see Price Index. Please inquire if you need a size not listed above.

STOCK COMPRESSION SPRINGS

Music Wire/Oil Tempered & Stainless (See Below)

Ends Squared and Ground Ends to be Square Within 3 Degrees of Axis

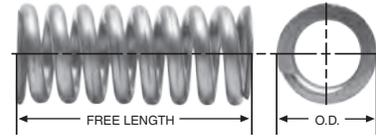

DIAMOND WIRE SPRING STOCK NO.	OUTSIDE DIAMETER	TO WORK IN HOLE DIA.	TO WORK OVER ROD DIA.	WIRE DIA.	APPROX. LOAD AT SOLID HT.	FREE LENGTH	SOLID HT.	TOTAL DEFLECTION	SPRING RATE	PRICE GROUP	
	IN.	IN.	IN.	IN.	LB.	IN.	IN.	IN.	LB./IN.	OT/MW	SS
DWC-035EE-8.5	0.375	0.390	0.294	0.035	4.506	1.125	0.402	0.723	6.2	A	B
DWC-035EE-9						1.250	0.442	0.808	5.6	A	B
DWC-035EE-9.5						1.375	0.481	0.894	5.0	A	B
DWC-035EE-10						1.500	0.520	0.980	4.6	A	B
DWC-035EE-11						1.750	0.598	1.152	3.9	B	C
DWC-035EE-12						2.000	0.677	1.323	3.4	B	C
DWC-035EE-12.5						2.250	0.755	1.495	3.0	B	C
DWC-035EE-13	2.500	0.833	1.667	2.7	B	C					
DWC-032EF-4	0.390	0.406	0.281	0.032	4.700	0.500	0.143	0.357	13.3	B	C
DWC-032EF-5						0.625	0.166	0.459	10.3	B	C
DWC-032EF-6						0.750	0.189	0.561	8.4	B	C
DWC-032EF-7						0.875	0.212	0.663	7.1	B	C
DWC-032EF-8						1.000	0.234	0.766	6.2	B	C
DWC-032EF-9						1.250	0.280	0.970	4.9	B	C
DWC-032EF-10						1.500	0.325	1.175	4.0	B	C
DWC-032EF-11	1.750	0.371	1.379	3.4	B	C					
DWC-032EF-12	2.000	0.416	1.584	3.0	B	C					
DWC-038EF-4	0.390	0.406	0.281	0.038	7.700	0.500	0.183	0.317	24.4	B	C
DWC-038EF-5						0.625	0.215	0.410	18.8	B	C
DWC-038EF-6						0.750	0.246	0.504	15.3	B	C
DWC-038EF-7						0.875	0.278	0.597	12.9	B	C
DWC-038EF-8						1.000	0.310	0.690	11.2	B	C
DWC-038EF-9						1.250	0.373	0.877	8.8	B	C
DWC-038EF-10						1.500	0.436	1.064	7.3	B	C
DWC-038EF-11	1.750	0.499	1.251	6.2	B	C					
DWC-038EF-12	2.000	0.562	1.438	5.4	B	C					
DWC-043EF-4	0.390	0.406	0.281	0.043	10.493	0.500	0.224	0.276	37.7	B	C
DWC-043EF-4.5						0.563	0.245	0.318	33.0	B	C
DWC-043EF-5						0.625	0.267	0.358	28.2	B	C
DWC-043EF-5.5						0.688	0.288	0.400	26.0	B	C
DWC-043EF-6						0.750	0.310	0.440	23.8	B	C
DWC-043EF-6.5						0.813	0.327	0.486	22.0	B	C
DWC-043EF-7						0.875	0.348	0.527	19.8	B	C
DWC-043EF-7.5						0.938	0.370	0.568	18.3	B	C
DWC-043EF-8						1.000	0.391	0.609	16.7	B	C
DWC-043EF-8.5						1.125	0.435	0.690	15.0	B	C
DWC-043EF-9						1.250	0.473	0.777	13.2	B	C
DWC-043EF-9.5						1.375	0.516	0.859	12.3	B	C
DWC-043EF-10						1.500	0.559	0.941	11.0	B	C
DWC-043EF-11	1.750	0.640	1.110	9.4	B	C					
DWC-043EF-12	2.000	0.705	1.295	8.2	B	C					
DWC-047EF-4	0.390	0.406	0.281	0.047	13.665	0.500	0.249	0.251	54.8	B	C
DWC-047EF-4.5						0.563	0.273	0.290	47.5	B	C
DWC-047EF-5						0.625	0.296	0.329	41.7	B	C
DWC-047EF-5.5						0.688	0.320	0.368	38.0	B	C
DWC-047EF-6						0.750	0.343	0.407	34.2	B	C
DWC-047EF-6.5						0.813	0.366	0.447	31.5	B	C

COMPRESSION SPRINGS

Note: Wire Dia. up to .098" is Music Wire (MW); .105" and over is Oil Tempered Wire (OT). Stainless available up to .135" wire size. Above rates and loads are multiplied by .833 when using stainless. For prices from 1 to 100 see Price Index. Please inquire if you need a size not listed above.

STOCK COMPRESSION SPRINGS

Music Wire/Oil Tempered & Stainless (See Below)

Ends Squared and Ground Ends to be Square Within 3 Degrees of Axis

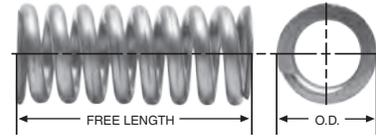

COMPRESSION SPRINGS

DIAMOND WIRE SPRING STOCK NO.	OUTSIDE DIAMETER	TO WORK IN HOLE DIA.	TO WORK OVER ROD DIA.	WIRE DIA.	APPROX. LOAD AT SOLID HT.	FREE LENGTH	SOLID HT.	TOTAL DEFLECTION	SPRING RATE	PRICE GROUP	
	IN.	IN.	IN.	IN.	LB.	IN.	IN.	IN.	LB./IN.	OT/MW	SS
DWC-047EF-7	0.390	0.406	0.281	0.047	13.665	0.875	0.395	0.480	28.2	B	C
DWC-047EF-7.5						0.938	0.418	0.520	26.5	B	C
DWC-047EF-8						1.000	0.442	0.558	24.8	B	C
DWC-047EF8.5						1.125	0.489	0.636	22.0	B	C
DWC-047EF-9						1.250	0.536	0.714	19.0	B	C
DWC-047EF-9.5						1.375	0.583	0.792	17.5	B	C
DWC-047EF-10						1.500	0.630	0.870	15.7	B	C
DWC-047EF-11						1.750	0.729	1.021	13.5	B	C
DWC-047EF-12	2.000	0.832	1.168	11.5	B	C					
DWC-051EF-4	0.390	0.406	0.250	0.051	17.200	0.500	0.271	0.229	75.2	B	C
DWC-051EF-5						0.625	0.324	0.301	57.2	B	C
DWC-051EF-6						0.750	0.377	0.373	46.2	B	C
DWC-051EF-7						0.875	0.431	0.444	38.7	B	C
DWC-051EF-8						1.000	0.484	0.516	33.3	B	C
DWC-051EF-9						1.250	0.590	0.660	26.1	B	C
DWC-051EF-10						1.500	0.697	0.803	21.4	B	C
DWC-051EF-11						1.750	0.803	0.947	18.2	B	C
DWC-051EF-12	2.000	0.909	1.091	15.8	B	C					
DWC-055EF-4	0.390	0.406	0.250	0.055	21.300	0.500	0.295	0.205	104.1	B	C
DWC-055EF-5						0.625	0.354	0.271	78.8	B	C
DWC-055EF-6						0.750	0.414	0.336	63.5	B	C
DWC-055EF-7						0.875	0.472	0.403	53.1	B	C
DWC-055EF-8						1.000	0.532	0.468	45.6	B	C
DWC-055EF-9						1.250	0.651	0.599	35.6	B	C
DWC-055EF-10						1.500	0.769	0.731	29.2	B	C
DWC-055EF-11						1.750	0.888	0.862	24.8	B	C
DWC-055EF-12	2.000	1.006	0.994	21.5	B	C					
DWC-035F-4	0.420	0.437	0.312	0.035	6.750	0.500	0.172	0.328	19.7	A	B
DWC-035F-5						0.625	0.191	0.434	15.4	A	B
DWC-035F-6						0.750	0.211	0.539	12.5	A	B
DWC-035F-7						0.875	0.231	0.644	10.5	A	B
DWC-035F-8						1.000	0.250	0.750	9.1	A	B
DWC-035F-9						1.250	0.289	0.961	7.2	A	B
DWC-035F-10						1.500	0.328	1.172	5.9	A	B
DWC-035F-11						1.750	0.367	1.383	5.1	B	C
DWC-038F-4	0.420	0.437	0.312	0.038	8.207	0.500	0.172	0.328	22.0	A	B
DWC-038F-5						0.625	0.194	0.431	18.0	A	B
DWC-038F-6						0.750	0.223	0.527	14.5	A	B
DWC-038F-7						0.875	0.246	0.629	12.5	A	B
DWC-038F-8						1.000	0.269	0.731	11.0	A	B
DWC-038F-9						1.250	0.326	0.924	8.5	A	B
DWC-038F-10						1.500	0.372	1.128	7.2	A	B
DWC-038F-11						1.750	0.423	1.327	6.6	B	C
DWC-038F-12						2.000	0.456	1.544	6.1	B	C
DWC-038F-12.5						2.250	0.550	1.700	4.6	B	C
DWC-042F-4	0.420	0.437	0.312	0.042	10.965	0.500	0.190	0.310	34.0	A	B
DWC-042F-5						0.625	0.213	0.412	28.0	A	B

Note: Wire Dia. up to .098" is Music Wire (MW); .105" and over is Oil Tempered Wire (OT). Stainless available up to .135" wire size. Above rates and loads are multiplied by .833 when using stainless. For prices from 1 to 100 see Price Index. Please inquire if you need a size not listed above.

STOCK COMPRESSION SPRINGS

Music Wire/Oil Tempered & Stainless (See Below)

Ends Squared and Ground Ends to be Square Within 3 Degrees of Axis

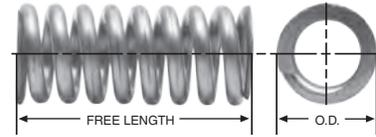

DIAMOND WIRE SPRING STOCK NO.	OUTSIDE DIAMETER	TO WORK IN HOLE DIA.	TO WORK OVER ROD DIA.	WIRE DIA.	APPROX. LOAD AT SOLID HT.	FREE LENGTH	SOLID HT.	TOTAL DEFLECTION	SPRING RATE	PRICE GROUP	
	IN.	IN.	IN.	IN.	LB.	IN.	IN.	IN.	LB./IN.	OT/MW	SS
DWC-042F-6	0.420	0.437	0.312	0.042	10.965	0.750	0.248	0.502	22.0	A	B
DWC-042F-7						0.875	0.280	0.595	18.5	A	B
DWC-042F-8						1.000	0.310	0.690	16.0	A	B
DWC-042F-9						1.250	0.363	0.887	13.0	B	C
DWC-042F-10						1.500	0.429	1.071	10.5	B	C
DWC-042F-11						1.750	0.501	1.249	9.3	B	C
DWC-042F-12						2.000	0.558	1.442	8.1	B	C
DWC-042F-12.5						2.250	0.636	1.614	6.7	B	C
DWC-042F-13	2.500	0.699	1.801	6.0	B	C					
DWC-045F-4	0.420	0.437	0.312	0.045	12.982	0.500	0.214	0.286	42.0	A	B
DWC-045F-5						0.625	0.244	0.381	34.0	A	B
DWC-045F-6						0.750	0.284	0.466	27.0	A	B
DWC-045F-7						0.875	0.318	0.557	23.0	A	B
DWC-045F-8						1.000	0.352	0.648	20.0	A	B
DWC-045F-9						1.250	0.418	0.832	16.0	B	C
DWC-045F-10						1.500	0.493	1.007	13.0	B	C
DWC-045F-11						1.750	0.563	1.187	11.8	C	D
DWC-045F-12						2.000	0.627	1.373	10.2	C	D
DWC-045F-12.5						2.250	0.725	1.525	8.4	C	D
DWC-045F-13	2.500	0.791	1.709	7.6	C	D					
DWC-048F-4	0.420	0.437	0.312	0.048	15.000	0.500	0.261	0.239	60.6	A	B
DWC-048F-6						0.750	0.334	0.416	37.4	A	B
DWC-048F-8						1.000	0.407	0.593	27.1	A	B
DWC-048F-9						1.250	0.480	0.770	21.2	B	C
DWC-048F-10						1.500	0.552	0.948	17.4	B	C
DWC-048F-11						1.750	0.625	1.125	14.8	C	D
DWC-048F-12	2.000	0.698	1.302	12.9	C	D					
DWC-051F-4	0.420	0.437	0.281	0.051	17.654	0.500	0.282	0.218	76.4	A	B
DWC-051F-5						0.625	0.321	0.304	58.7	A	B
DWC-051F-6						0.750	0.363	0.387	46.9	A	B
DWC-051F-7						0.875	0.406	0.469	39.1	A	B
DWC-051F-8						1.000	0.445	0.555	33.9	A	B
DWC-051F-9						1.250	0.526	0.724	26.5	B	C
DWC-051F-10						1.500	0.607	0.893	21.7	B	C
DWC-051F-11						1.750	0.688	1.062	18.4	C	E
DWC-051F-12						2.000	0.769	1.231	16.0	C	E
DWC-051F-12.5						2.250	0.881	1.369	13.4	C	E
DWC-051F-13	2.500	0.971	1.529	12.0	C	E					
DWC-055F-4	0.420	0.437	0.281	0.055	22.692	0.500	0.273	0.227	95.0	A	B
DWC-055F-5						0.625	0.316	0.309	75.0	A	B
DWC-055F-6						0.750	0.360	0.390	62.0	A	B
DWC-055F-7						0.875	0.408	0.467	52.0	A	B
DWC-055F-8						1.000	0.454	0.546	45.0	A	B
DWC-055F-9						1.250	0.553	0.697	35.0	B	C
DWC-055F-10						1.500	0.645	0.855	29.0	B	C
DWC-055F-11						1.750	0.772	0.978	24.5	C	E
DWC-055F-12	2.000	0.865	1.135	21.3	C	E					

COMPRESSION SPRINGS

Note: Wire Dia. up to .098" is Music Wire (MW); .105" and over is Oil Tempered Wire (OT). Stainless available up to .135" wire size. Above rates and loads are multiplied by .833 when using stainless. For prices from 1 to 100 see Price Index. Please inquire if you need a size not listed above.

STOCK COMPRESSION SPRINGS

Music Wire/Oil Tempered & Stainless (See Below)

Ends Squared and Ground Ends to be Square Within 3 Degrees of Axis

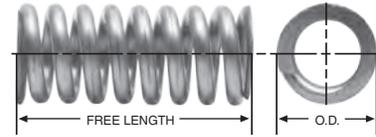

COMPRESSION SPRINGS

DIAMOND WIRE SPRING STOCK NO.	OUTSIDE DIAMETER	TO WORK IN HOLE DIA.	TO WORK OVER ROD DIA.	WIRE DIA.	APPROX. LOAD AT SOLID HT.	FREE LENGTH	SOLID HT.	TOTAL DEFLECTION	SPRING RATE	PRICE GROUP	
	IN.	IN.	IN.	IN.	LB.	IN.	IN.	IN.	LB./IN.	OT/MW	SS
DWC-055F-12.5	0.420	0.437	0.281	0.055	22.692	2.250	0.950	1.300	18.0	D	F
DWC-055F-13						2.500	1.045	1.455	16.3	D	F
DWC-059F-4	0.420	0.438	0.293	0.059	29.449	0.500	0.285	0.215	136.8	A	B
DWC-059F-5						0.625	0.339	0.286	103.1	A	B
DWC-059F-6						0.750	0.394	0.356	82.7	B	C
DWC-059F-7						0.875	0.448	0.427	69.0	B	C
DWC-059F-8						1.000	0.503	0.497	59.2	B	C
DWC-059F-9						1.250	0.612	0.638	46.2	C	D
DWC-059F10						1.500	0.721	0.779	37.8	C	D
DWC-059F-11						1.750	0.830	0.920	32.0	D	E
DWC-059F-12						2.000	0.939	1.061	27.8	D	E
DWC-059F-12.5						2.250	1.048	1.202	24.5	E	F
DWC-059F-13	2.500	1.157	1.343	21.9	E	F					
DWC-063F-4	0.420	0.437	0.281	0.063	31.993	0.500	0.345	0.155	182.1	C	D
DWC-063F-5						0.625	0.416	0.209	137.9	C	D
DWC-063F-6						0.750	0.476	0.274	109.2	C	D
DWC-063F-7						0.875	0.536	0.339	90.3	C	D
DWC-063F-8						1.000	0.591	0.409	77.9	C	D
DWC-063F-9						1.250	0.706	0.544	60.6	D	E
DWC-063F-10						1.500	0.821	0.679	49.6	D	E
DWC-063F-11						1.750	0.917	0.833	41.9	E	F
DWC-063F-11						1.750	0.937	0.813	41.9	E	H
DWC-063F-12						2.000	1.052	0.948	36.3	E	H
DWC-063F-12.5	2.250	1.159	1.091	32.0	F	H					
DWC-063F-13	2.500	1.277	1.223	28.7	F	H					
DWC-067F-6	0.420	0.438	0.277	0.067	44.111	0.750	0.468	0.282	143.7	C	D
DWC-067F-8						1.000	0.602	0.398	102.2	D	E
DWC-067F-9						1.250	0.736	0.514	79.3	D	E
DWC-067F-10						1.500	0.870	0.630	64.8	E	F
DWC-067F-11						1.750	1.004	0.746	54.8	E	F
DWC-067F-12						2.000	1.138	0.862	47.4	F	G
DWC-067F-12.5						2.250	1.272	0.978	41.8	F	G
DWC-067F-13						2.500	1.406	1.094	37.4	F	G
DWC-072F-8	.420	.438	.265	.072	47.906	1.000	0.658	0.342	139.2	D	E
DWC-072F-9						1.250	0.806	0.444	107.7	D	E
DWC-072F-10						1.500	0.955	0.545	87.9	E	F
DWC-072F-11						1.750	1.104	0.646	74.2	E	F
DWC-072F-12						2.000	1.253	0.747	64.2	F	G
DWC-072F-12.5						2.250	1.401	0.849	56.6	F	G
DWC-072F-13	2.500	1.550	0.950	50.6	F	G					
DWC-032FF-4	0.437	0.469	0.359	0.032	3.867	0.500	0.138	0.362	10.7	A	B
DWC-032FF-5						0.625	0.159	0.466	8.3	A	B
DWC-032FF-6						0.750	0.180	0.570	6.8	A	B
DWC-032FF-7						0.875	0.201	0.674	5.7	A	B
DWC-032FF-8						1.000	0.222	0.778	5.0	A	B
DWC-032FF-9						1.250	0.264	0.986	3.9	A	B

Note: Wire Dia. up to .098" is Music Wire (MW); .105" and over is Oil Tempered Wire (OT). Stainless available up to .135" wire size. Above rates and loads are multiplied by .833 when using stainless. For prices from 1 to 100 see Price Index. Please inquire if you need a size not listed above.

STOCK COMPRESSION SPRINGS

Music Wire/Oil Tempered & Stainless (See Below)

Ends Squared and Ground Ends to be Square Within 3 Degrees of Axis

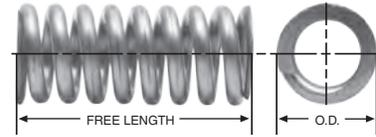

DIAMOND WIRE SPRING STOCK NO.	OUTSIDE DIAMETER	TO WORK IN HOLE DIA.	TO WORK OVER ROD DIA.	WIRE DIA.	APPROX. LOAD AT SOLID HT.	FREE LENGTH	SOLID HT.	TOTAL DEFLECTION	SPRING RATE	PRICE GROUP	
	IN.	IN.	IN.	IN.	LB.	IN.	IN.	IN.	LB./IN.	OT/MW	SS
DWC-032FF-10	0.437	0.469	0.359	0.032	3.867	1.500	0.306	1.194	3.2	A	B
DWC-032FF-11						1.750	0.348	1.402	2.8	A	B
DWC-032FF-12						2.000	0.390	1.610	2.4	A	B
DWC-041FF-4	0.437	0.469	0.343	0.041	7.796	0.500	0.196	0.304	25.6	A	B
DWC-041FF-5						0.625	0.230	0.395	19.7	A	B
DWC-041FF-6						0.750	0.264	0.486	16.0	A	B
DWC-041FF-7						0.875	0.297	0.578	13.5	A	B
DWC-041FF-8						1.000	0.331	0.669	11.7	A	B
DWC-041FF-9						1.250	0.399	0.851	9.2	A	B
DWC-041FF-10						1.500	0.466	1.034	7.5	A	B
DWC-041FF-11						1.750	0.534	1.216	6.4	A	B
DWC-041FF-12						2.000	0.601	1.399	5.6	A	B
DWC-054FF-4	0.437	0.469	0.318	0.054	16.684	0.500	0.279	0.221	75.0	A	B
DWC-054FF-5						0.625	0.333	0.292	56.9	A	B
DWC-054FF-6						0.750	0.386	0.364	45.8	A	B
DWC-054FF-7						0.875	0.440	0.435	38.3	A	B
DWC-054FF-8						1.000	0.494	0.506	33.0	A	B
DWC-054FF-9						1.250	0.601	0.649	25.7	A	B
DWC-054FF-10						1.500	0.709	0.791	21.1	A	B
DWC-054FF-11						1.750	0.816	0.934	17.9	B	C
DWC-054FF-12						2.000	0.923	1.077	15.5	B	C
DWC-054FF-1.25						2.250	1.031	1.219	13.7	B	C
DWC-054FF-13						2.500	1.138	1.362	12.3	B	C
DWC-039FG-4	0.455	0.468	0.344	0.039	6.500	0.500	0.172	0.328	19.8	B	C
DWC-039FG-5						0.625	0.199	0.426	15.5	B	C
DWC-039FG-6						0.750	0.226	0.524	12.3	B	C
DWC-039FG-7						0.875	0.254	0.621	10.5	B	C
DWC-039FG-8						1.000	0.283	0.717	9.2	B	C
DWC-039FG-9						1.250	0.339	0.911	7.0	B	C
DWC-039FG-10						1.500	0.394	1.106	5.6	B	C
DWC-039FG-11						1.750	0.448	1.302	4.8	B	C
DWC-039FG-12						2.000	0.492	1.508	4.4	B	C
DWC-046FG-4	0.455	0.468	0.344	0.046	10.500	0.500	0.212	0.288	36.7	B	C
DWC-046FG-5						0.625	0.248	0.377	28.2	B	C
DWC-046FG-6						0.750	0.285	0.465	22.8	B	C
DWC-046FG-7						0.875	0.322	0.553	19.0	B	C
DWC-046FG-8						1.000	0.359	0.641	16.5	B	C
DWC-046FG-9						1.250	0.432	0.818	12.8	C	D
DWC-046FG-10						1.500	0.506	0.994	10.5	C	D
DWC-046FG-11						1.750	0.575	1.175	9.0	C	D
DWC-046FG-12						2.000	0.645	1.355	7.8	C	E
DWC-051FG-4	0.455	0.468	0.328	0.051	14.900	0.500	0.236	0.264	56.3	A	B
DWC-051FG-5						0.625	0.277	0.348	42.9	A	B
DWC-051FG-6						0.750	0.320	0.430	35.5	A	B
DWC-051FG-7						0.875	0.362	0.513	29.0	A	B
DWC-051FG-8						1.000	0.403	0.597	25.0	A	B
DWC-051FG-9						1.250	0.488	0.762	19.5	B	C

COMPRESSION SPRINGS

Note: Wire Dia. up to .098" is Music Wire (MW); .105" and over is Oil Tempered Wire (OT). Stainless available up to .135" wire size. Above rates and loads are multiplied by .833 when using stainless. For prices from 1 to 100 see Price Index. Please inquire if you need a size not listed above.

STOCK COMPRESSION SPRINGS

Music Wire/Oil Tempered & Stainless (See Below)

Ends Squared and Ground Ends to be Square Within 3 Degrees of Axis

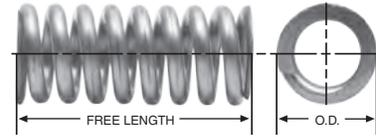

COMPRESSION SPRINGS

DIAMOND WIRE SPRING STOCK NO.	OUTSIDE DIAMETER	TO WORK IN HOLE DIA.	TO WORK OVER ROD DIA.	WIRE DIA.	APPROX. LOAD AT SOLID HT.	FREE LENGTH	SOLID HT.	TOTAL DEFLECTION	SPRING RATE	PRICE GROUP	
	IN.	IN.	IN.	IN.	LB.	IN.	IN.	IN.	LB./IN.	OT/MW	SS
DWC-051FG-10	0.455	0.468	0.328	0.051	14.900	1.500	0.572	0.928	16.0	B	C
DWC-051FG-11						1.750	0.656	1.094	13.6	C	E
DWC-051FG-12						2.000	0.740	1.260	11.8	C	E
DWC-055FG-4	0.455	0.468	0.312	0.055	18.400	0.500	0.259	0.241	76.1	A	B
DWC-055FG-5						0.625	0.306	0.319	57.6	A	B
DWC-055FG-6						0.750	0.354	0.396	46.4	A	B
DWC-055FG-7						0.875	0.402	0.473	38.8	A	B
DWC-055FG-8						1.000	0.449	0.551	33.3	A	B
DWC-055FG-9						1.250	0.544	0.706	26.1	B	C
DWC-055FG-10						1.500	0.640	0.860	21.3	B	C
DWC-055FG-11						1.750	0.735	1.015	18.1	C	E
DWC-055FG-12						2.000	0.830	1.170	15.7	C	E
DWC-063FG-4	0.455	0.468	0.281	0.063	22.700	0.500	0.317	0.183	124.1	A	C
DWC-063FG-5						0.625	0.381	0.244	93.1	A	C
DWC-063FG-6						0.750	0.445	0.305	74.3	A	C
DWC-063FG-7						0.875	0.508	0.367	61.9	A	C
DWC-063FG-8						1.000	0.572	0.428	53.1	B	D
DWC-063FG-9						1.250	0.701	0.549	41.3	B	D
DWC-063FG-10						1.500	0.828	0.672	33.8	B	D
DWC-063FG-11						1.750	0.956	0.794	28.6	C	E
DWC-063FG-12						2.000	1.084	0.916	24.8	C	E
DWC-072FG-4	0.455	0.468	0.281	0.072	32.300	0.500	0.359	0.141	230.0	B	D
DWC-072FG-5						0.625	0.435	0.190	170.2	B	D
DWC-072FG-6						0.750	0.510	0.240	135.1	B	D
DWC-072FG-7						0.875	0.586	0.289	112.0	B	D
DWC-072FG-8						1.000	0.662	0.338	95.6	C	E
DWC-072FG-9						1.250	0.813	0.437	74.0	C	E
DWC-072FG-10						1.500	0.964	0.536	60.4	C	F
DWC-072FG-11						1.750	1.115	0.635	51.0	D	F
DWC-072FG-12						2.000	1.266	0.734	44.1	D	G
DWC-036G-4	0.480	0.500	0.399	0.036	5.646	0.500	0.142	0.358	15.7	A	B
DWC-036G-5						0.625	0.162	0.463	12.2	A	B
DWC-036G-6						0.750	0.182	0.568	9.9	A	B
DWC-036G-7						0.875	0.202	0.673	8.4	A	B
DWC-036G-8						1.000	0.222	0.778	7.2	A	B
DWC-036G-9						1.250	0.261	0.989	5.7	B	C
DWC-036G-10						1.500	0.301	1.199	4.7	B	C
DWC-036G-11						1.750	0.341	1.409	4.0	C	D
DWC-036G-12						2.000	0.380	1.620	3.5	C	D
DWC-036G-12.5						2.250	0.420	1.830	3.1	C	D
DWC-036G-13						2.500	0.460	2.040	2.8	D	E
DWC-036G-13.5						2.750	0.499	2.251	2.5	D	E
DWC-036G-14						3.000	0.539	2.461	2.3	D	E
DWC-038G-4						0.480	0.500	0.375	0.038	6.889	0.500
DWC-038G-5	0.625	0.167	0.458	15.0	A						B
DWC-038G-6	0.750	0.185	0.565	12.5	A						B
DWC-038G-7	0.875	0.207	0.668	10.5	A						B

Note: Wire Dia. up to .098" is Music Wire (MW); .105" and over is Oil Tempered Wire (OT). Stainless available up to .135" wire size. Above rates and loads are multiplied by .833 when using stainless. For prices from 1 to 100 see Price Index. Please inquire if you need a size not listed above.

STOCK COMPRESSION SPRINGS

Music Wire/Oil Tempered & Stainless (See Below)

Ends Squared and Ground Ends to be Square Within 3 Degrees of Axis

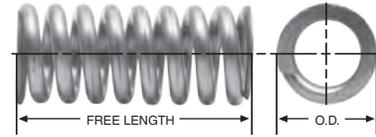

DIAMOND WIRE SPRING STOCK NO.	OUTSIDE DIAMETER	TO WORK IN HOLE DIA.	TO WORK OVER ROD DIA.	WIRE DIA.	APPROX. LOAD AT SOLID HT.	FREE LENGTH	SOLID HT.	TOTAL DEFLECTION	SPRING RATE	PRICE GROUP	
	IN.	IN.	IN.	IN.	LB.	IN.	IN.	IN.	LB./IN.	OT/MW	SS
DWC-038G-8	0.480	0.500	0.375	0.038	6.889	1.000	0.220	0.780	9.5	A	B
DWC-038G-9						1.250	0.259	0.991	7.5	B	C
DWC-038G-10						1.500	0.305	1.195	6.0	B	C
DWC-038G-10.5						1.625	0.332	1.293	5.5	B	C
DWC-038G-11						1.750	0.352	1.398	5.5	C	D
DWC-038G-12						2.000	0.388	1.612	4.8	C	D
DWC-038G-12.5						2.250	0.460	1.790	3.7	C	D
DWC-038G-13						2.500	0.503	1.997	3.3	D	E
DWC-038G-13.5						2.750	0.546	2.204	3.0	D	E
DWC-038G-14	3.000	0.589	2.411	2.7	D	E					
DWC-042G-4	0.480	0.500	0.375	0.042	9.538	0.500	0.167	0.333	28.0	A	B
DWC-042G-5						0.625	0.194	0.431	21.0	A	B
DWC-042G-6						0.750	0.213	0.537	18.0	A	B
DWC-042G-7						0.875	0.239	0.636	15.0	A	B
DWC-042G-8						1.000	0.263	0.737	13.0	A	B
DWC-042G-9						1.250	0.317	0.933	10.0	B	C
DWC-042G-10						1.500	0.358	1.142	8.5	B	C
DWC-042G-10.5						1.625	0.400	1.225	7.7	B	C
DWC-042G-11						1.750	0.418	1.332	7.7	B	C
DWC-042G-12						2.000	0.462	1.538	6.7	B	C
DWC-042G-12.5						2.250	0.504	1.746	5.5	D	E
DWC-042G-13						2.500	0.562	1.938	5.0	E	F
DWC-042G-13.5						2.750	0.610	2.140	4.5	E	F
DWC-042G-14						3.000	0.659	2.341	4.1	F	G
DWC-045G-4	0.480	0.500	0.375	0.045	11.463	0.500	0.185	0.315	35.0	A	B
DWC-045G-5						0.625	0.209	0.416	28.0	A	B
DWC-045G-6						0.750	0.242	0.508	22.0	A	B
DWC-045G-7						0.875	0.266	0.609	19.0	A	B
DWC-045G-8						1.000	0.287	0.713	17.0	A	B
DWC-045G-9						1.250	0.348	0.902	13.0	B	C
DWC-045G-10						1.500	0.395	1.105	11.0	B	C
DWC-045G-10.5						1.625	0.446	1.179	9.8	B	C
DWC-045G-11						1.750	0.469	1.281	9.6	B	D
DWC-045G-12						2.000	0.520	1.480	8.4	B	D
DWC-045G-12.5						2.250	0.610	1.640	6.7	C	D
DWC-045G-13						2.500	0.666	1.834	6.2	C	D
DWC-045G-13.5						2.750	0.686	2.064	5.6	E	F
DWC-045G-14						3.000	0.742	2.258	5.1	E	F
DWC-051G-4	0.480	0.500	0.344	0.051	15.888	0.500	0.255	0.245	61.3	A	B
DWC-051G-5						0.625	0.286	0.339	47.1	A	B
DWC-051G-6						0.750	0.320	0.430	37.7	A	B
DWC-051G-7						0.875	0.353	0.522	31.4	A	B
DWC-051G-8						1.000	0.384	0.616	27.2	A	B
DWC-051G-9						1.250	0.448	0.802	21.3	B	C
DWC-051G-10						1.500	0.513	0.987	17.5	B	C
DWC-051G-10.5						1.625	0.550	1.075	14.8	C	D
DWC-051G-11						1.750	0.577	1.173	14.8	D	E

COMPRESSION SPRINGS

Note: Wire Dia. up to .098" is Music Wire (MW); .105" and over is Oil Tempered Wire (OT). Stainless available up to .135" wire size. Above rates and loads are multiplied by .833 when using stainless. For prices from 1 to 100 see Price Index. Please inquire if you need a size not listed above.

STOCK COMPRESSION SPRINGS

Music Wire/Oil Tempered & Stainless (See Below)

Ends Squared and Ground Ends to be Square Within 3 Degrees of Axis

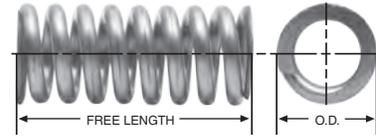

COMPRESSION SPRINGS

DIAMOND WIRE SPRING STOCK NO.	OUTSIDE DIAMETER	TO WORK IN HOLE DIA.	TO WORK OVER ROD DIA.	WIRE DIA.	APPROX. LOAD AT SOLID HT.	FREE LENGTH	SOLID HT.	TOTAL DEFLECTION	SPRING RATE	PRICE GROUP	
	IN.	IN.	IN.	IN.	LB.	IN.	IN.	IN.	LB./IN.	OT/MW	SS
DWC-051G-12	0.480	0.500	0.344	0.051	15.888	2.000	0.641	1.359	12.9	D	E
DWC-051G-13.5						2.750	0.900	1.850	8.3	D	E
DWC-051G-14						3.000	0.975	2.025	7.6	E	F
DWC-055G-4	0.480	0.500	0.344	0.055	19.530	0.500	0.246	0.254	72.0	A	C
DWC-055G-5						0.625	0.285	0.340	56.0	A	C
DWC-055G-6						0.750	0.319	0.431	47.0	A	C
DWC-055G-7						0.875	0.368	0.507	38.0	A	C
DWC-055G-8						1.000	0.391	0.609	35.0	A	C
DWC-055G-9						1.250	0.474	0.776	27.0	B	D
DWC-055G-10						1.500	0.557	0.943	22.0	B	D
DWC-055G-10.5						1.625	0.605	1.020	20.0	C	D
DWC-055G-11						1.750	0.651	1.099	19.4	C	E
DWC-055G-12						2.000	0.725	1.275	16.8	C	E
DWC-055G-12.5						2.250	0.835	1.415	14.2	C	D
DWC-055G-13						2.500	0.927	1.573	12.5	C	D
DWC-055G-13.5	2.750	1.022	1.728	10.9	D	E					
DWC-055G-14	3.000	1.107	1.893	10.0	E	F					
DWC-059G-4	0.480	0.500	0.344	0.059	23.445	0.500	0.305	0.195	107.2	A	C
DWC-059G-5						0.625	0.346	0.279	81.6	A	C
DWC-059G-6						0.750	0.390	0.360	64.8	A	C
DWC-059G-8						1.000	0.474	0.526	46.4	B	D
DWC-059G-9						1.250	0.558	0.692	36.2	B	D
DWC-059G-10						1.500	0.642	0.858	29.6	B	D
DWC-059G-10.5						1.625	0.678	0.947	25.5	B	D
DWC-059G-11						1.750	0.726	1.024	25.1	C	E
DWC-059G-12						2.000	0.810	1.190	21.8	C	E
DWC-059G-12.5						2.250	0.915	1.335	18.0	D	E
DWC-059G-13						2.500	1.000	1.500	16.0	D	E
DWC-059G-13.5						2.750	1.102	1.648	14.7	E	F
DWC-059G-14	3.000	1.194	1.806	13.5	E	F					
DWC-063G-4	0.480	0.500	0.312	0.063	27.585	0.500	0.296	0.204	120.0	A	C
DWC-063G-5						0.625	0.342	0.283	95.0	A	C
DWC-063G-6						0.750	0.388	0.362	78.0	A	C
DWC-063G-7						0.875	0.436	0.439	66.0	A	C
DWC-063G-8						1.000	0.485	0.515	57.0	B	D
DWC-063G-9						1.250	0.582	0.668	45.0	B	D
DWC-063G-10						1.500	0.665	0.835	38.0	B	D
DWC-063G-10.5						1.625	0.755	0.870	34.0	B	D
DWC-063G-11						1.750	0.801	0.949	32.2	C	E
DWC-063G-12						2.000	0.895	1.105	27.9	C	E
DWC-063G-12.5						2.250	1.037	1.213	24.0	C	E
DWC-063G-13						2.500	1.142	1.358	21.3	E	F
DWC-063G-14	3.000	1.354	1.646	17.0	E	F					
DWC-067G-4	0.480	0.500	0.312	0.067	34.010	0.500	0.336	0.164	180.7	B	D
DWC-067G-5						0.625	0.403	0.222	136.1	B	D
DWC-067G-6						0.750	0.458	0.292	107.4	B	D
DWC-067G-7						0.875	0.512	0.363	88.7	B	D

Note: Wire Dia. up to .098" is Music Wire (MW); .105" and over is Oil Tempered Wire (OT). Stainless available up to .135" wire size. Above rates and loads are multiplied by .833 when using stainless. For prices from 1 to 100 see Price Index. Please inquire if you need a size not listed above.

STOCK COMPRESSION SPRINGS

Music Wire/Oil Tempered & Stainless (See Below)

Ends Squared and Ground Ends to be Square Within 3 Degrees of Axis

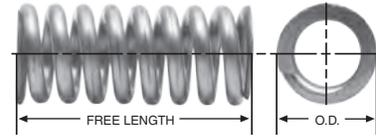

DIAMOND WIRE SPRING STOCK NO.	OUTSIDE DIAMETER	TO WORK IN HOLE DIA.	TO WORK OVER ROD DIA.	WIRE DIA.	APPROX. LOAD AT SOLID HT.	FREE LENGTH	SOLID HT.	TOTAL DEFLECTION	SPRING RATE	PRICE GROUP	
	IN.	IN.	IN.	IN.	LB.	IN.	IN.	IN.	LB./IN.	OT/MW	SS
DWC-067G-8	0.480	0.500	0.312	0.067	34.010	1.000	0.562	0.438	76.4	C	E
DWC-067G-9						1.250	0.666	0.584	59.3	C	E
DWC-067G-10						1.500	0.770	0.730	48.4	C	E
DWC-067G-11						1.750	0.874	0.876	40.9	E	G
DWC-067G-12						2.000	0.978	1.022	35.4	E	G
DWC-067G-12.5						2.250	1.078	1.172	30.8	F	G
DWC-067G-13						2.500	1.186	1.314	27.6	G	H
DWC-067G-13.5						2.750	1.294	1.456	25.0	H	I
DWC-067G-14	3.000	1.405	1.595	22.8	H	I					
DWC-072G-4	0.480	0.500	0.327	0.072	44.660	0.500	0.324	0.176	250.0	C	D
DWC-072G-5						0.625	0.386	0.239	185.0	C	D
DWC-072G-6						0.750	0.448	0.302	146.9	C	D
DWC-072G-7						0.875	0.510	0.365	121.7	C	D
DWC-072G-8						1.000	0.572	0.428	104.0	D	E
DWC-072G-9						1.250	0.695	0.555	80.5	D	E
DWC-072G-10						1.500	0.819	0.681	65.7	D	E
DWC-072G-11						1.750	0.942	0.808	55.4	F	G
DWC-072G-12						2.000	1.066	0.934	48.0	F	G
DWC-072G-12.5						2.250	1.190	1.060	42.3	G	H
DWC-072G-13						2.500	1.313	1.187	37.8	H	I
DWC-072G-13.5						2.750	1.437	1.313	34.2	I	J
DWC-072G-14						3.000	1.560	1.440	31.2	I	J
DWC-072G-14.5						3.250	1.681	1.569	28.7	I	J
DWC-072G-15						3.500	1.809	1.691	26.5	I	J
DWC-075G-4	0.480	0.500	0.319	0.075	46.040	0.500	0.345	0.155	289.1	C	D
DWC-075G-5						0.625	0.410	0.215	215.6	C	D
DWC-075G-6						0.750	0.480	0.270	169.1	C	D
DWC-075G-7						0.875	0.551	0.324	139.0	C	D
DWC-075G-8						1.000	0.616	0.384	119.4	D	E
DWC-075G-9						1.250	0.752	0.498	92.3	D	E
DWC-075G-10						1.500	0.887	0.613	75.3	D	E
DWC-075G-11						1.750	1.023	0.727	63.5	F	G
DWC-075G-12						2.000	1.157	0.843	55.0	F	G
DWC-075G-12.5						2.250	1.294	0.956	48.4	G	H
DWC-075G-13						2.500	1.429	1.071	43.3	H	I
DWC-075G-13.5						2.750	1.566	1.184	39.1	I	J
DWC-075G-14						3.000	1.700	1.300	35.7	I	J
DWC-075G-14.5						3.250	1.837	1.413	32.8	I	J
DWC-075G-15						3.500	1.969	1.531	30.4	I	J
DWC-080G-4	0.480	0.500	0.311	0.080	68.002	0.500	0.340	0.160	425.9	D	E
DWC-080G-5						0.625	0.407	0.218	311.4	D	E
DWC-080G-6						0.750	0.473	0.277	245.4	D	E
DWC-080G-7						0.875	0.539	0.336	202.5	D	E
DWC-080G-8						1.000	0.606	0.394	172.4	E	F
DWC-080G-9						1.250	0.738	0.512	132.8	E	F
DWC-080G-10						1.500	0.871	0.629	108.1	E	F
DWC-080G-11						1.750	1.003	0.747	91.1	G	H

COMPRESSION SPRINGS

Note: Wire Dia. up to .098" is Music Wire (MW); .105" and over is Oil Tempered Wire (OT). Stainless available up to .135" wire size. Above rates and loads are multiplied by .833 when using stainless. For prices from 1 to 100 see Price Index. Please inquire if you need a size not listed above.

STOCK COMPRESSION SPRINGS

Music Wire/Oil Tempered & Stainless (See Below)

Ends Squared and Ground Ends to be Square Within 3 Degrees of Axis

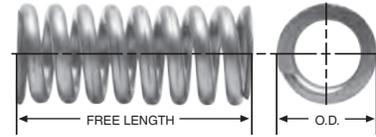

COMPRESSION SPRINGS

DIAMOND WIRE SPRING STOCK NO.	OUTSIDE DIAMETER	TO WORK IN HOLE DIA.	TO WORK OVER ROD DIA.	WIRE DIA.	APPROX. LOAD AT SOLID HT.	FREE LENGTH	SOLID HT.	TOTAL DEFLECTION	SPRING RATE	PRICE GROUP	
	IN.	IN.	IN.	IN.	LB.	IN.	IN.	IN.	LB./IN.	OT/MW	SS
DWC-080G-12	0.480	0.500	0.311	0.080	68.002	2.000	1.136	0.864	78.7	G	H
DWC-080G-12.5						2.250	1.269	0.981	69.3	H	I
DWC-080G-13						2.500	1.401	1.099	61.9	I	J
DWC-080G-13.5						2.750	1.534	1.216	55.9	J	K
DWC-080G-14						3.000	1.666	1.334	51.0	J	K
DWC-041GG-4	0.500	0.531	0.406	0.041	5.580	0.500	0.188	0.312	17.8	A	B
DWC-041GG-5						0.625	0.219	0.406	13.7	A	B
DWC-041GG-6						0.750	0.250	0.500	11.2	A	B
DWC-041GG-7						0.875	0.281	0.594	9.4	A	B
DWC-041GG-8						1.000	0.312	0.688	8.1	A	B
DWC-041GG-9						1.250	0.374	0.876	6.4	B	C
DWC-041GG-10						1.500	0.436	1.064	5.3	B	C
DWC-041GG-11						1.750	0.498	1.252	4.5	B	C
DWC-041GG-12						2.000	0.560	1.440	3.9	B	C
DWC-041GG-1.25						2.250	0.623	1.627	3.4	B	C
DWC-041GG-13						2.500	0.685	1.815	3.1	B	C
DWC-041GG-13.5						2.750	0.747	2.003	2.8	B	C
DWC-041GG-14						3.000	0.809	2.191	2.6	B	C
DWC-062GG-4						0.500	0.531	0.364	0.062	17.814	0.500
DWC-062GG-5	0.625	0.376	0.249	71.1	A						B
DWC-062GG-6	0.750	0.438	0.312	56.9	A						B
DWC-062GG-7	0.875	0.500	0.375	47.4	A						B
DWC-062GG-8	1.000	0.562	0.438	40.6	A						B
DWC-062GG-9	1.250	0.685	0.565	31.6	B						C
DWC-062GG-10	1.500	0.809	0.691	25.8	B						C
DWC-062GG-11	1.750	0.933	0.817	21.9	C						D
DWC-062GG-12	2.000	1.057	0.943	19.0	C						D
DWC-062GG-1.25	2.250	1.180	1.070	16.7	C						D
DWC-062GG-13	2.500	1.304	1.196	15.0	C						D
DWC-062GG-13.5	2.750	1.428	1.322	13.5	D						E
DWC-062GG-14	3.000	1.552	1.448	12.4	D						E
DWC-072GG-4	0.500	0.531	0.345	0.072	32.934						0.500
DWC-072GG-5						0.625	0.405	0.220	148.2	D	E
DWC-072GG-6						0.750	0.472	0.278	117.7	D	E
DWC-072GG-7						0.875	0.539	0.336	97.6	D	E
DWC-072GG-8						1.000	0.605	0.395	83.3	E	F
DWC-072GG-9						1.250	0.739	0.511	64.5	E	F
DWC-072GG-10						1.500	0.873	0.627	52.6	E	F
DWC-072GG-11						1.750	1.006	0.744	44.4	G	H
DWC-072GG-12						2.000	1.140	0.860	38.4	G	H
DWC-072GG-1.25						2.250	1.274	0.976	33.9	H	I
DWC-072GG-13						2.500	1.407	1.093	30.3	I	J
DWC-072GG-13.5						2.750	1.541	1.209	27.4	J	K
DWC-072GG-14						3.000	1.675	1.325	25.0	J	K
DWC-072GG-14.5						3.250	1.808	1.442	23.0	K	L
DWC-072GG-15						3.500	1.942	1.558	21.3	K	L

Note: Wire Dia. up to .098" is Music Wire (MW); .105" and over is Oil Tempered Wire (OT). Stainless available up to .135" wire size. Above rates and loads are multiplied by .833 when using stainless. For prices from 1 to 100 see Price Index. Please inquire if you need a size not listed above.

STOCK COMPRESSION SPRINGS

Music Wire/Oil Tempered & Stainless (See Below)

Ends Squared and Ground Ends to be Square Within 3 Degrees of Axis

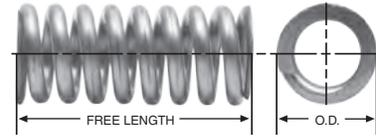

DIAMOND WIRE SPRING STOCK NO.	OUTSIDE DIAMETER	TO WORK IN HOLE DIA.	TO WORK OVER ROD DIA.	WIRE DIA.	APPROX. LOAD AT SOLID HT.	FREE LENGTH	SOLID HT.	TOTAL DEFLECTION	SPRING RATE	PRICE GROUP						
	IN.	IN.	IN.	IN.	LB.	IN.	IN.	IN.	LB./IN.	OT/MW	SS					
DWC-041GH-5	0.540	0.562	0.437	0.041	7.000	0.625	0.177	0.448	16.0	A	C					
DWC-041GH-6						0.750	0.197	0.553	13.0	A	C					
DWC-041GH-7						0.875	0.217	0.658	11.0	A	C					
DWC-041GH-8						1.000	0.237	0.763	9.4	A	C					
DWC-041GH-9						1.250	0.276	0.974	7.3	B	D					
DWC-041GH-10						1.500	0.315	1.185	6.0	B	D					
DWC-041GH-11						1.750	0.355	1.395	5.0	B	D					
DWC-041GH-12						2.000	0.395	1.605	4.4	B	D					
DWC-041GH-13						2.500	0.473	2.027	3.4	B	D					
DWC-041GH-14						3.000	0.552	2.448	2.8	B	D					
DWC-041GH-15						3.500	0.643	2.857	2.4	B	D					
DWC-045GH-5						0.540	0.562	0.421	0.045	9.000	0.625	0.194	0.431	21.0	A	C
DWC-045GH-6											0.750	0.219	0.531	17.0	A	C
DWC-045GH-7											0.875	0.243	0.632	14.3	A	C
DWC-045GH-8											1.000	0.268	0.732	12.3	B	C
DWC-045GH-9	1.250	0.316	0.934	9.7	B						D					
DWC-045GH-10	1.500	0.365	1.135	8.0	B						D					
DWC-045GH-11	1.750	0.414	1.336	6.8	C						E					
DWC-045GH-12	2.000	0.463	1.537	5.9	C						E					
DWC-045GH-13	2.500	0.561	1.939	4.7	C						E					
DWC-045GH-14	3.000	0.658	2.342	3.9	D						F					
DWC-045GH-15	3.500	0.756	2.744	3.3	D	F										
DWC-054GH-5	0.540	0.562	0.406	0.054	16.000	0.625	0.256	0.369	43.2	A	C					
DWC-054GH-6						0.750	0.290	0.460	34.7	A	C					
DWC-054GH-7						0.875	0.323	0.552	29.0	A	C					
DWC-054GH-8						1.000	0.356	0.644	25.0	A	C					
DWC-054GH-9						1.250	0.423	0.827	19.5	B	D					
DWC-054GH-10						1.500	0.490	1.010	15.8	B	D					
DWC-054GH-11						1.750	0.557	1.193	13.5	C	E					
DWC-054GH-12						2.000	0.624	1.376	11.6	C	E					
DWC-054GH-13						2.500	0.757	1.743	9.1	C	E					
DWC-054GH-14						3.000	0.891	2.109	7.5	D	F					
DWC-054GH-15	3.500	1.007	2.493	6.4	D	F										
DWC-058GH-4	0.540	0.562	0.408	0.058	20.030	0.500	0.242	0.258	75.8	A	B					
DWC-058GH-5						0.625	0.280	0.345	57.2	A	B					
DWC-058GH-6						0.750	0.318	0.432	45.9	A	B					
DWC-058GH-7						0.875	0.355	0.520	38.4	A	B					
DWC-058GH-8						1.000	0.393	0.607	33.0	B	C					
DWC-058GH-9						1.250	0.469	0.781	25.7	B	C					
DWC-058GH-10						1.500	0.544	0.956	21.0	B	C					
DWC-058GH-11						1.750	0.620	1.130	17.8	C	D					
DWC-058GH-12						2.000	0.695	1.305	15.5	C	D					
DWC-058GH-12.5						2.250	0.771	1.479	13.7	C	D					
DWC-058GH-13						2.500	0.846	1.654	12.2	E	F					
DWC-058GH-13.5						2.750	0.922	1.828	11.0	E	F					
DWC-058GH-14						3.000	0.997	2.003	10.1	E	F					

COMPRESSION SPRINGS

Note: Wire Dia. up to .098" is Music Wire (MW); .105" and over is Oil Tempered Wire (OT). Stainless available up to .135" wire size. Above rates and loads are multiplied by .833 when using stainless. For prices from 1 to 100 see Price Index. Please inquire if you need a size not listed above.

STOCK COMPRESSION SPRINGS

Music Wire/Oil Tempered & Stainless (See Below)

Ends Squared and Ground Ends to be Square Within 3 Degrees of Axis

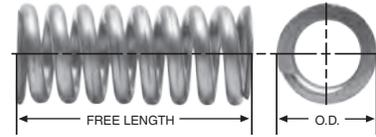

COMPRESSION SPRINGS

DIAMOND WIRE SPRING STOCK NO.	OUTSIDE DIAMETER	TO WORK IN HOLE DIA.	TO WORK OVER ROD DIA.	WIRE DIA.	APPROX. LOAD AT SOLID HT.	FREE LENGTH	SOLID HT.	TOTAL DEFLECTION	SPRING RATE	PRICE GROUP						
	IN.	IN.	IN.	IN.	LB.	IN.	IN.	IN.	LB./IN.	OT/MW	SS					
DWC-063GH-5	0.540	0.562	0.375	0.063	25.000	0.625	0.310	0.315	78.8	A	D					
DWC-063GH-6						0.750	0.353	0.397	63.0	A	D					
DWC-063GH-7						0.875	0.397	0.478	52.3	A	D					
DWC-063GH-8						1.000	0.440	0.560	44.8	B	E					
DWC-063GH-9						1.250	0.527	0.723	34.8	B	E					
DWC-063GH-10						1.500	0.614	0.886	28.5	B	E					
DWC-063GH-11						1.750	0.701	1.049	24.0	C	F					
DWC-063GH-12						2.000	0.788	1.212	20.8	C	F					
DWC-063GH-13						2.500	0.962	1.538	16.3	C	G					
DWC-063GH-14						3.000	1.136	1.864	13.5	E	H					
DWC-063GH-15						3.500	1.269	2.231	11.5	E	H					
DWC-072GH-5						0.540	0.562	0.359	0.072	30.500	0.625	0.371	0.254	119.6	C	E
DWC-072GH-6											0.750	0.430	0.320	94.9	C	E
DWC-072GH-7											0.875	0.489	0.386	78.7	C	E
DWC-072GH-8											1.000	0.548	0.452	67.2	D	F
DWC-072GH-9	1.250	0.665	0.585	52.1	D						F					
DWC-072GH-10	1.500	0.783	0.717	42.4	D						F					
DWC-072GH-11	1.750	0.901	0.849	35.8	D						F					
DWC-072GH-12	2.000	1.019	0.981	31.0	D						F					
DWC-072GH-13	2.500	1.255	1.245	24.4	F						I					
DWC-072GH-14	3.000	1.490	1.510	20.7	F						I					
DWC-072GH-15	3.500	1.727	1.773	17.2	F						I					
DWC-054GI-5	0.563	0.594	0.436	0.054	11.210						0.625	0.278	0.347	32.2	A	B
DWC-054GI-6											0.750	0.318	0.432	25.9	A	B
DWC-054GI-7											0.875	0.359	0.516	21.7	A	B
DWC-054GI-8											1.000	0.399	0.601	18.6	A	B
DWC-054GI-9						1.250	0.480	0.770	14.6	B	C					
DWC-054GI-10						1.500	0.561	0.939	11.9	B	C					
DWC-054GI-11						1.750	0.642	1.108	10.1	C	D					
DWC-054GI-12						2.000	0.723	1.277	8.8	C	D					
DWC-054GI-1.25						2.250	0.804	1.446	7.8	C	D					
DWC-054GI-13						2.500	0.885	1.615	7.0	C	D					
DWC-054GI-14						3.000	1.046	1.954	5.7	D	E					
DWC-054GI-14.5						3.250	1.127	2.123	5.3	E	F					
DWC-054GI-15						3.500	1.208	2.292	4.9	E	F					
DWC-054GI-15.5						3.750	1.289	2.461	4.6	F	G					
DWC-054GI-16						4.000	1.370	2.630	4.3	G	H					
DWC-091GI-5						0.563	0.594	0.362	0.091	83.704	0.625	0.418	0.207	397.5	G	H
DWC-091GI-6	0.750	0.483	0.267	310.0	D						E					
DWC-091GI-7	0.875	0.548	0.327	254.1	D						E					
DWC-091GI-8	1.000	0.613	0.387	215.3	D						E					
DWC-091GI-9	1.250	0.743	0.507	164.9	E						F					
DWC-091GI-10	1.500	0.873	0.627	133.6	E						F					
DWC-091GI-11	1.750	1.003	0.747	112.3	F						G					
DWC-091GI-12	2.000	1.133	0.867	96.9	F						G					
DWC-091GI-1.25	2.250	1.264	0.986	85.2	F						G					
DWC-091GI-13	2.500	1.394	1.106	76.0	F						G					

Note: Wire Dia. up to .098" is Music Wire (MW); .105" and over is Oil Tempered Wire (OT). Stainless available up to .135" wire size. Above rates and loads are multiplied by .833 when using stainless. For prices from 1 to 100 see Price Index. Please inquire if you need a size not listed above.

STOCK COMPRESSION SPRINGS

Music Wire/Oil Tempered & Stainless (See Below)

Ends Squared and Ground Ends to be Square Within 3 Degrees of Axis

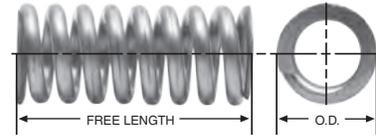

DIAMOND WIRE SPRING STOCK NO.	OUTSIDE DIAMETER	TO WORK IN HOLE DIA.	TO WORK OVER ROD DIA.	WIRE DIA.	APPROX. LOAD AT SOLID HT.	FREE LENGTH	SOLID HT.	TOTAL DEFLECTION	SPRING RATE	PRICE GROUP	
	IN.	IN.	IN.	IN.	LB.	IN.	IN.	IN.	LB./IN.	OT/MW	SS
DWC-091GI-14	0.563	0.594	0.362	0.091	83.704	3.000	1.654	1.346	62.5	H	I
DWC-091GI-14.5						3.250	1.784	1.466	57.4	H	I
DWC-091GI-15						3.500	1.914	1.586	53.1	H	I
DWC-091GI-15.5						3.750	2.044	1.706	49.4	H	I
DWC-091GI-16						4.000	2.175	1.825	46.1	H	I
DWC-045H-5	0.600	0.625	0.468	0.045	7.918	0.625	0.179	0.446	18.0	A	C
DWC-045H-6						0.750	0.205	0.545	14.0	A	C
DWC-045H-7						0.875	0.224	0.651	12.0	A	C
DWC-045H-8						1.000	0.251	0.749	10.0	A	C
DWC-045H-9						1.250	0.292	0.958	8.0	B	D
DWC-045H-10						1.500	0.338	1.162	6.5	B	D
DWC-045H-11						1.750	0.358	1.392	5.8	B	D
DWC-045H-12						2.000	0.400	1.600	5.0	B	D
DWC-045H-13						2.500	0.478	2.022	4.0	B	D
DWC-045H-14						3.000	0.560	2.440	3.3	B	D
DWC-045H-14.5						3.250	0.667	2.583	2.9	E	F
DWC-045H-15						3.500	0.711	2.789	2.7	E	F
DWC-049H-5	0.600	0.625	0.468	0.049	11.500	0.625	0.234	0.391	28.0	A	C
DWC-049H-6						0.750	0.255	0.495	22.4	A	C
DWC-049H-8						1.000	0.297	0.703	16.2	A	C
DWC-049H-9						1.250	0.338	0.912	12.7	B	D
DWC-049H-10						1.500	0.380	1.120	10.4	B	D
DWC-049H-11						1.750	0.422	1.328	8.8	C	E
DWC-049H-12						2.000	0.463	1.537	7.7	C	E
DWC-049H-13						2.500	0.546	1.954	6.1	C	E
DWC-049H-14	3.000	0.629	2.371	5.0	D	F					
DWC-055H-5	0.600	0.625	0.468	0.055	16.500	0.625	0.226	0.399	40.0	A	C
DWC-055H-6						0.750	0.251	0.499	33.0	A	C
DWC-055H-7						0.875	0.276	0.599	28.0	A	C
DWC-055H-8						1.000	0.304	0.696	24.0	A	C
DWC-055H-9						1.250	0.369	0.881	18.0	B	D
DWC-055H-10						1.500	0.420	1.080	15.0	B	D
DWC-055H-11						1.750	0.509	1.241	13.0	C	E
DWC-055H-12						2.000	0.562	1.438	11.3	C	E
DWC-055H-13						2.500	0.667	1.833	8.9	C	E
DWC-055H-14	3.000	0.752	2.248	7.6	D	F					
DWC-059H-5	0.600	0.625	0.468	0.059	18.500	0.625	0.198	0.427	53.7	A	B
DWC-059H-6						0.750	0.329	0.421	42.7	A	B
DWC-059H-7						0.875	0.360	0.515	35.4	A	B
DWC-059H-8						1.000	0.389	0.611	30.6	B	D
DWC-059H-9						1.250	0.449	0.801	23.8	B	D
DWC-059H-10						1.500	0.510	0.990	19.5	B	D
DWC-059H-11						1.750	0.570	1.180	16.5	C	E
DWC-059H-12						2.000	0.630	1.370	14.3	C	E
DWC-059H-13						2.500	0.750	1.750	11.3	C	G
DWC-059H-14						3.000	0.871	2.129	9.4	E	H

COMPRESSION SPRINGS

Note: Wire Dia. up to .098" is Music Wire (MW); .105" and over is Oil Tempered Wire (OT). Stainless available up to .135" wire size. Above rates and loads are multiplied by .833 when using stainless. For prices from 1 to 100 see Price Index. Please inquire if you need a size not listed above.

STOCK COMPRESSION SPRINGS

Music Wire/Oil Tempered & Stainless (See Below)

Ends Squared and Ground Ends to be Square Within 3 Degrees of Axis

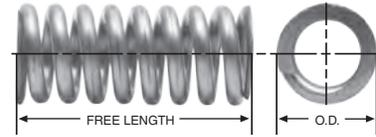

COMPRESSION SPRINGS

DIAMOND WIRE SPRING STOCK NO.	OUTSIDE DIAMETER	TO WORK IN HOLE DIA.	TO WORK OVER ROD DIA.	WIRE DIA.	APPROX. LOAD AT SOLID HT.	FREE LENGTH	SOLID HT.	TOTAL DEFLECTION	SPRING RATE	PRICE GROUP						
	IN.	IN.	IN.	IN.	LB.	IN.	IN.	IN.	LB./IN.	OT/MW	SS					
DWC-063H-5	0.600	0.625	0.437	0.063	22.872	0.625	0.280	0.345	62.0	A	D					
DWC-063H-6						0.750	0.314	0.436	51.0	A	D					
DWC-063H-7						0.875	0.343	0.532	44.0	A	D					
DWC-063H-8						1.000	0.378	0.622	38.0	B	E					
DWC-063H-9						1.250	0.435	0.815	31.0	B	E					
DWC-063H-10						1.500	0.526	0.974	24.0	B	E					
DWC-063H-11						1.750	0.632	1.118	20.8	C	F					
DWC-063H-12						2.000	0.700	1.300	18.0	C	F					
DWC-063H-13						2.500	0.836	1.664	14.2	C	G					
DWC-063H-14						3.000	0.927	2.073	12.5	E	H					
DWC-063H-14.5						3.250	1.077	2.173	10.2	F	H					
DWC-063H-15						3.500	1.153	2.347	9.5	F	H					
DWC-067H-5						0.600	0.625	0.437	0.067	28.000	0.625	0.300	0.325	80.0	A	D
DWC-067H-6											0.750	0.336	0.414	66.0	B	E
DWC-067H-7											0.875	0.401	0.474	50.0	B	E
DWC-067H-8	1.000	0.430	0.570	45.0	B						E					
DWC-067H-9	1.250	0.505	0.745	36.0	B						E					
DWC-067H-10	1.500	0.594	0.906	29.0	B						E					
DWC-067H-11	1.750	0.715	1.035	23.0	B						F					
DWC-067H-12	2.000	0.771	1.229	22.5	D						G					
DWC-067H-13	2.500	0.923	1.577	17.7	D						G					
DWC-067H-14	3.000	1.040	1.960	15.3	E						H					
DWC-072H-5	0.600	0.625	0.437	0.072	31.000	0.625	0.381	0.244	114.5	B	E					
DWC-072H-6						0.750	0.396	0.354	78.0	B	E					
DWC-072H-7						0.875	0.433	0.442	68.0	B	E					
DWC-072H-8						1.000	0.502	0.498	55.0	B	E					
DWC-072H-9						1.250	0.581	0.669	45.0	B	E					
DWC-072H-10						1.500	0.691	0.809	36.0	C	F					
DWC-072H-11						1.750	0.801	0.949	30.0	C	F					
DWC-072H-12						2.000	0.848	1.152	28.0	D	G					
DWC-072H-13						2.500	1.033	1.467	23.1	D	H					
DWC-072H-14						3.000	1.206	1.794	19.1	F	I					
DWC-080H-5	0.600	0.625	0.424	0.080	53.558	0.625	0.351	0.274	193.5	B	D					
DWC-080H-6						0.750	0.401	0.349	152.5	B	D					
DWC-080H-7						0.875	0.451	0.424	125.8	B	D					
DWC-080H-8						1.000	0.501	0.499	107.1	B	D					
DWC-080H-9						1.250	0.601	0.649	82.5	C	E					
DWC-080H-10						1.500	0.701	0.799	67.1	C	E					
DWC-080H-11						1.750	0.801	0.949	56.6	D	F					
DWC-080H-12						2.000	0.901	1.099	48.9	D	F					
DWC-080H-12.5						2.250	1.001	1.249	43.1	D	F					
DWC-080H-13						2.500	1.102	1.398	38.4	D	F					
DWC-080H-13.5						2.750	1.202	1.548	34.7	F	H					
DWC-080H-14						3.000	1.302	1.698	31.7	F	H					
DWC-085H-5						0.600	0.625	0.414	0.085	63.409	0.625	0.375	0.250	250.7	C	D
DWC-085H-6											0.750	0.430	0.320	196.6	C	D
DWC-085H-7											0.875	0.485	0.390	161.8	C	D

Note: Wire Dia. up to .098" is Music Wire (MW); .105" and over is Oil Tempered Wire (OT). Stainless available up to .135" wire size. Above rates and loads are multiplied by .833 when using stainless. For prices from 1 to 100 see Price Index. Please inquire if you need a size not listed above.

STOCK COMPRESSION SPRINGS

Music Wire/Oil Tempered & Stainless (See Below)

Ends Squared and Ground Ends to be Square Within 3 Degrees of Axis

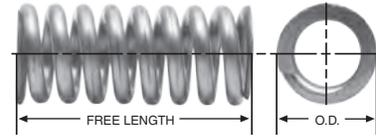

DIAMOND WIRE SPRING STOCK NO.	OUTSIDE DIAMETER	TO WORK IN HOLE DIA.	TO WORK OVER ROD DIA.	WIRE DIA.	APPROX. LOAD AT SOLID HT.	FREE LENGTH	SOLID HT.	TOTAL DEFLECTION	SPRING RATE	PRICE GROUP	
	IN.	IN.	IN.	IN.	LB.	IN.	IN.	IN.	LB./IN.	OT/MW	SS
DWC-085H-8	0.600	0.625	0.414	0.085	63.409	1.000	0.540	0.460	137.4	C	D
DWC-085H-9						1.250	0.650	0.600	105.6	D	E
DWC-085H-10						1.500	0.760	0.740	85.8	D	E
DWC-085H-11						1.750	0.870	0.880	72.2	E	F
DWC-085H-12						2.000	0.980	1.020	62.3	E	F
DWC-085H-12.5						2.250	1.090	1.160	54.8	E	F
DWC-085H-13						2.500	1.200	1.300	49.0	E	F
DWC-085H-13.5						2.750	1.310	1.440	44.2	G	H
DWC-085H-14						3.000	1.420	1.580	40.3	G	H
DWC-085H-14.5						3.250	1.531	1.719	37.0	G	H
DWC-085H-15	3.500	1.640	1.860	34.3	G	H					
DWC-092H-5	0.600	0.625	0.400	0.092	86.438	0.625	0.397	0.228	373.6	D	E
DWC-092H-6						0.750	0.456	0.294	291.0	D	E
DWC-092H-7						0.875	0.515	0.360	238.4	D	E
DWC-092H-8						1.000	0.574	0.426	201.9	D	E
DWC-092H-9						1.250	0.692	0.558	154.5	E	F
DWC-092H-10						1.500	0.810	0.690	125.2	E	F
DWC-092H-11						1.750	0.928	0.822	105.2	F	G
DWC-092H-12						2.000	1.046	0.954	90.7	F	G
DWC-092H-12.5						2.250	1.164	1.086	79.8	F	G
DWC-092H-13						2.500	1.281	1.219	71.1	F	G
DWC-092H-13.5						2.750	1.399	1.351	64.2	H	I
DWC-092H-14						3.000	1.517	1.483	58.5	H	I
DWC-092H-14.5						3.250	1.633	1.617	53.8	H	I
DWC-092H-15						3.500	1.752	1.748	49.7	H	I
DWC-092H-15.5						3.750	1.867	1.883	46.3	H	I
DWC-092H-16						4.000	1.987	2.013	43.2	H	I
DWC-098H-6	0.600	0.625	0.385	0.098	103.574	0.750	0.486	0.264	387.8	D	E
DWC-098H-7						0.875	0.553	0.322	314.1	D	E
DWC-098H-8						1.000	0.615	0.385	267.2	D	E
DWC-098H-9						1.250	0.743	0.507	203.9	E	F
DWC-098H-10						1.500	0.871	0.629	164.8	E	F
DWC-098H-11						1.750	1.000	0.750	138.3	F	G
DWC-098H-12						2.000	1.128	0.872	119.1	F	G
DWC-098H-12.5						2.250	1.257	0.993	104.6	F	G
DWC-098H-13						2.500	1.385	1.115	93.3	F	G
DWC-098H-13.5						2.750	1.514	1.236	84.1	H	I
DWC-098H-14						3.000	1.643	1.357	76.6	H	I
DWC-098H-14.5						3.250	1.769	1.481	70.4	H	I
DWC-098H-15						3.500	1.900	1.600	65.0	H	I
DWC-098H-15.5						3.750	2.026	1.724	60.5	H	I
DWC-098H-16						4.000	2.155	1.845	56.5	H	I
DWC-120HH-7						0.625	0.656	0.367	0.120	127.052	0.875
DWC-120HH-8	1.000	0.771	0.229	545.9	K						N
DWC-120HH-9	1.250	0.943	0.307	410.8	K						N
DWC-120HH-10	1.500	1.115	0.385	329.3	K						N
DWC-120HH-11	1.750	1.288	0.462	274.8	K						N

Note: Wire Dia. up to .098" is Music Wire (MW); .105" and over is Oil Tempered Wire (OT). Stainless available up to .135" wire size. Above rates and loads are multiplied by .833 when using stainless. For prices from 1 to 100 see Price Index. Please inquire if you need a size not listed above.

STOCK COMPRESSION SPRINGS

Music Wire/Oil Tempered & Stainless (See Below)

Ends Squared and Ground Ends to be Square Within 3 Degrees of Axis

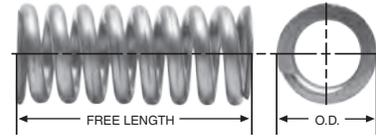

COMPRESSION SPRINGS

DIAMOND WIRE SPRING STOCK NO.	OUTSIDE DIAMETER	TO WORK IN HOLE DIA.	TO WORK OVER ROD DIA.	WIRE DIA.	APPROX. LOAD AT SOLID HT.	FREE LENGTH	SOLID HT.	TOTAL DEFLECTION	SPRING RATE	PRICE GROUP	
	IN.	IN.	IN.	IN.	LB.	IN.	IN.	IN.	LB./IN.	OT/MW	SS
DWC-120HH-12	0.625	0.656	0.367	0.120	127.052	2.000	1.460	0.540	235.7	K	N
DWC-120HH-12.5						2.250	1.632	0.618	206.4	L	N
DWC-120HH-13						2.500	1.805	0.695	183.6	L	O
DWC-120HH-13.5						2.750	1.977	0.773	165.3	M	P
DWC-120HH-13						3.000	2.149	0.851	150.3	M	P
DWC-120HH-14.5						3.250	2.322	0.928	137.8	N	Q
DWC-120HH-15						3.500	2.494	1.006	127.2	N	Q
DWC-120HH-16						4.000	2.839	1.161	110.3	P	S
DWC-049HI-6	0.660	0.687	0.531	0.049	9.500	0.750	0.210	0.540	18.0	B	E
DWC-049HI-7						0.875	0.230	0.645	15.0	B	E
DWC-049HI-8						1.000	0.249	0.751	13.0	B	E
DWC-049HI-9						1.250	0.288	0.962	10.0	B	E
DWC-049HI-10						1.500	0.328	1.172	8.2	B	E
DWC-049HI-11						1.750	0.367	1.383	7.0	B	E
DWC-049HI-12						2.000	0.406	1.594	6.0	D	G
DWC-049HI-13						2.500	0.484	2.016	4.7	D	G
DWC-049HI-14						3.000	0.562	2.438	3.8	E	H
DWC-049HI-15						3.500	0.639	2.861	3.3	E	I
DWC-055HI-6	0.660	0.687	0.531	0.049	13.000	0.750	0.238	0.512	25.5	C	F
DWC-055HI-7						0.875	0.263	0.612	21.3	C	F
DWC-055HI-8						1.000	0.288	0.712	18.3	C	F
DWC-055HI-9						1.250	0.338	0.912	14.3	C	F
DWC-055HI-10						1.500	0.388	1.112	11.7	C	F
DWC-055HI-11						1.750	0.438	1.312	10.0	D	G
DWC-055HI-12						2.000	0.489	1.511	8.6	D	G
DWC-055HI-13						2.500	0.589	1.911	6.8	D	G
DWC-055HI-14						3.000	0.689	2.311	5.7	D	H
DWC-055HI-15	3.500	0.789	2.711	4.8	E	I					
DWC-063HI-6	0.660	0.687	0.500	0.063	20.000	0.750	0.293	0.457	44.2	C	F
DWC-063HI-7						0.875	0.325	0.550	36.8	C	F
DWC-063HI-8						1.000	0.356	0.644	31.6	C	F
DWC-063HI-9						1.250	0.419	0.831	24.5	D	G
DWC-063HI-10						1.500	0.482	1.018	20.0	D	G
DWC-063HI-11						1.750	0.545	1.205	17.0	D	G
DWC-063HI-12						2.000	0.608	1.392	14.5	D	G
DWC-063HI-13						2.500	0.734	1.766	11.5	E	H
DWC-063HI-14						3.000	0.860	2.140	9.5	E	H
DWC-063HI-15						3.500	0.955	2.545	8.1	E	I
DWC-067HI-5	0.660	0.687	0.510	0.067	24.734	0.625	0.281	0.344	70.7	C	F
DWC-067HI-6						0.750	0.316	0.434	56.4	C	F
DWC-067HI-7						0.875	0.351	0.524	46.9	C	F
DWC-067HI-8						1.000	0.386	0.614	40.1	C	F
DWC-067HI-9						1.250	0.456	0.794	31.1	D	G
DWC-067HI-10						1.500	0.526	0.974	25.5	D	G
DWC-067HI-11						1.750	0.596	1.154	21.5	D	G
DWC-067HI-12						2.000	0.666	1.334	18.6	D	G
DWC-067HI-12.5						2.250	0.736	1.514	16.5	F	I

Note: Wire Dia. up to .098" is Music Wire (MW); .105" and over is Oil Tempered Wire (OT). Stainless available up to .135" wire size. Above rates and loads are multiplied by .833 when using stainless. For prices from 1 to 100 see Price Index. Please inquire if you need a size not listed above.

STOCK COMPRESSION SPRINGS

Music Wire/Oil Tempered & Stainless (See Below)

Ends Squared and Ground Ends to be Square Within 3 Degrees of Axis

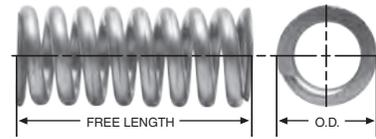

DIAMOND WIRE SPRING STOCK NO.	OUTSIDE DIAMETER	TO WORK IN HOLE DIA.	TO WORK OVER ROD DIA.	WIRE DIA.	APPROX. LOAD AT SOLID HT.	FREE LENGTH	SOLID HT.	TOTAL DEFLECTION	SPRING RATE	PRICE GROUP	
	IN.	IN.	IN.	IN.	LB.	IN.	IN.	IN.	LB./IN.	OT/MW	SS
DWC-067HI-13	0.660	0.687	0.510	0.067	24.734	2.500	0.806	1.694	14.7	F	I
DWC-067HI-13.5						2.750	0.876	1.874	13.3	F	I
DWC-067HI-14						3.000	0.946	2.054	12.1	F	I
DWC-072HI-6	0.660	0.687	0.500	0.072	30.500	0.750	0.345	0.405	74.5	C	G
DWC-072HI-7						0.875	0.385	0.490	61.7	C	G
DWC-072HI-8						1.000	0.424	0.576	52.7	C	G
DWC-072HI-9						1.250	0.503	0.747	40.7	D	H
DWC-072HI-10						1.500	0.582	0.918	33.2	D	H
DWC-072HI-11						1.750	0.661	1.089	28.0	D	H
DWC-072HI-12						2.000	0.739	1.261	24.2	D	H
DWC-072HI-13						2.500	0.897	1.603	19.0	F	I
DWC-072HI-14						3.000	1.055	1.945	15.6	F	I
DWC-072HI-15						3.500	1.174	2.326	13.3	F	I
DWC-081HI-6	0.660	0.687	0.468	0.081	36.000	0.750	0.407	0.343	105.2	E	H
DWC-081HI-7						0.875	0.459	0.416	86.9	E	H
DWC-081HI-8						1.000	0.512	0.488	73.8	E	H
DWC-081HI-9						1.250	0.616	0.634	56.8	E	I
DWC-081HI-10						1.500	0.720	0.780	46.3	E	I
DWC-081HI-11						1.750	0.825	0.925	39.0	E	J
DWC-081HI-12						2.000	0.929	1.071	33.6	F	K
DWC-081HI-13						2.500	1.137	1.363	26.5	H	M
DWC-081HI-14						3.000	1.345	1.655	21.8	I	O
DWC-081HI-15						3.500	1.555	1.945	18.5	I	O
DWC-105HJ-7	0.688	0.719	0.459	0.105	89.608	0.875	0.557	0.318	279.2	G	I
DWC-105HJ-8						1.000	0.622	0.378	235.0	G	I
DWC-105HJ-9						1.250	0.750	0.500	178.5	G	I
DWC-105HJ-10						1.500	0.878	0.622	143.9	G	I
DWC-105HJ-11						1.750	1.007	0.743	120.5	H	K
DWC-105HJ-12						2.000	1.135	0.865	103.7	I	L
DWC-105HJ-12.5						2.250	1.264	0.986	91.0	J	M
DWC-105HJ-13						2.500	1.392	1.108	81.1	J	N
DWC-105HJ-13.5						2.750	1.520	1.230	73.1	K	O
DWC-105HJ-13						3.000	1.649	1.351	66.5	L	P
DWC-105HJ-14.5						3.250	1.777	1.473	61.1	M	Q
DWC-105HJ-15						3.500	1.906	1.594	56.4	N	R
DWC-105HJ-16						4.000	2.162	1.838	49.0	N	R
DWC-150HJ-7	0.688	0.719	0.370	0.150	229.408	0.875	0.742	0.133	1665.0	L	O
DWC-150HJ-8						1.000	0.836	0.164	1367.0	L	O
DWC-150HJ-9						1.250	1.025	0.225	1007.0	L	O
DWC-150HJ-10						1.500	1.213	0.287	797.9	L	O
DWC-150HJ-11						1.750	1.402	0.348	660.3	L	O
DWC-150HJ-12						2.000	1.590	0.410	563.2	M	P
DWC-150HJ-12.5						2.250	1.779	0.471	491.0	N	R
DWC-150HJ-13						2.500	1.967	0.533	435.2	N	R
DWC-150HJ-13						3.000	2.344	0.656	354.6	P	T
DWC-150HJ-14.5						3.250	2.533	0.717	324.5	Q	U
DWC-150HJ-15						3.500	2.721	0.779	299.2	S	U

COMPRESSION SPRINGS

Note: Wire Dia. up to .098" is Music Wire (MW); .105" and over is Oil Tempered Wire (OT). Stainless available up to .135" wire size. Above rates and loads are multiplied by .833 when using stainless. For prices from 1 to 100 see Price Index. Please inquire if you need a size not listed above.

STOCK COMPRESSION SPRINGS

Music Wire/Oil Tempered & Stainless (See Below)

Ends Squared and Ground Ends to be Square Within 3 Degrees of Axis

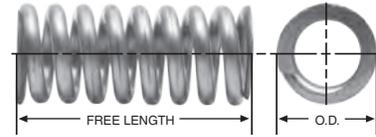

COMPRESSION SPRINGS

DIAMOND WIRE SPRING STOCK NO.	OUTSIDE DIAMETER	TO WORK IN HOLE DIA.	TO WORK OVER ROD DIA.	WIRE DIA.	APPROX. LOAD AT SOLID HT.	FREE LENGTH	SOLID HT.	TOTAL DEFLECTION	SPRING RATE	PRICE GROUP	
	IN.	IN.	IN.	IN.	LB.	IN.	IN.	IN.	LB./IN.	OT/MW	SS
DWC-0551-6	0.720	0.750	0.562	0.055	13.021	0.750	0.221	0.529	23.0	C	F
DWC-0551-7						0.875	0.238	0.637	20.0	C	F
DWC-0551-8						1.000	0.248	0.752	18.5	C	F
DWC-0551-9						1.250	0.281	0.969	15.0	C	F
DWC-0551-10						1.500	0.333	1.167	11.5	C	F
DWC-0551-11						1.750	0.388	1.362	9.2	D	G
DWC-0551-12						2.000	0.411	1.589	8.5	D	G
DWC-0551-12.5						2.250	0.467	1.783	7.3	D	G
DWC-0551-13						2.500	0.519	1.981	6.9	D	G
DWC-0551-13.5						2.750	0.548	2.202	6.0	D	G
DWC-0551-14	3.000	0.593	2.407	5.7	D	H					
DWC-0591-6	0.720	0.750	0.562	0.059	16.092	0.750	0.285	0.465	32.9	C	F
DWC-0591-7						0.875	0.308	0.567	27.3	C	F
DWC-0591-8						1.000	0.328	0.672	23.5	C	F
DWC-0591-9						1.250	0.371	0.879	18.3	D	G
DWC-0591-10						1.500	0.414	1.086	15.0	D	G
DWC-0591-11						1.750	0.457	1.293	12.7	D	G
DWC-0591-12						2.000	0.499	1.501	11.0	D	G
DWC-0591-12.5						2.250	0.515	1.735	9.7	D	G
DWC-0591-13	2.500	0.585	1.915	8.7	E	H					
DWC-0631-6	0.720	0.750	0.562	0.063	17.176	0.750	0.284	0.466	33.0	C	F
DWC-0631-7						0.875	0.313	0.562	28.0	C	F
DWC-0631-8						1.000	0.344	0.656	24.0	C	F
DWC-0631-9						1.250	0.409	0.841	18.5	D	G
DWC-0631-10						1.500	0.475	1.025	15.0	D	G
DWC-0631-11						1.750	0.529	1.221	13.0	D	G
DWC-0631-12						2.000	0.602	1.398	11.0	D	G
DWC-0631-12.5						2.250	0.673	1.577	10.0	D	G
DWC-0631-13						2.500	0.654	1.846	10.8	E	H
DWC-0631-13.5						2.750	0.792	1.958	8.0	E	H
DWC-0631-14	3.000	0.751	2.249	8.9	E	H					
DWC-0651-6	0.720	0.750	0.562	0.065	19.714	0.750	0.324	0.426	46.0	C	F
DWC-0651-7						0.875	0.351	0.524	38.0	C	F
DWC-0651-8						1.000	0.376	0.624	32.8	C	F
DWC-0651-9						1.250	0.428	0.822	25.4	D	G
DWC-0651-10						1.500	0.480	1.020	20.8	D	G
DWC-0651-11						1.750	0.532	1.218	17.6	D	G
DWC-0651-12						2.000	0.584	1.416	15.2	D	G
DWC-0651-12.5						2.250	0.660	1.590	12.0	D	G
DWC-0651-13						2.500	0.689	1.811	12.0	E	H
DWC-0651-13.5						2.750	0.818	1.932	9.2	E	H
DWC-0651-14	3.000	0.793	2.207	9.9	G	H					
DWC-0671-6	0.720	0.750	0.562	0.067	20.392	0.750	0.279	0.471	50.0	C	F
DWC-0671-7						0.875	0.315	0.560	40.0	C	F
DWC-0671-8						1.000	0.354	0.646	33.0	C	F
DWC-0671-9						1.250	0.403	0.847	27.0	D	G
DWC-0671-10						1.500	0.464	1.036	22.0	D	G

Note: Wire Dia. up to .098" is Music Wire (MW); .105" and over is Oil Tempered Wire (OT). Stainless available up to .135" wire size. Above rates and loads are multiplied by .833 when using stainless. For prices from 1 to 100 see Price Index. Please inquire if you need a size not listed above.

STOCK COMPRESSION SPRINGS

Music Wire/Oil Tempered & Stainless (See Below)

Ends Squared and Ground Ends to be Square Within 3 Degrees of Axis

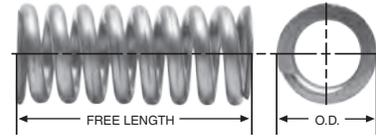

DIAMOND WIRE SPRING STOCK NO.	OUTSIDE DIAMETER	TO WORK IN HOLE DIA.	TO WORK OVER ROD DIA.	WIRE DIA.	APPROX. LOAD AT SOLID HT.	FREE LENGTH	SOLID HT.	TOTAL DEFLECTION	SPRING RATE	PRICE GROUP	
	IN.	IN.	IN.	IN.	LB.	IN.	IN.	IN.	LB./IN.	OT/MW	SS
DWC-067I-11	0.720	0.750	0.562	0.067	20.392	1.750	0.538	1.212	18.0	D	G
DWC-067I-12						2.000	0.603	1.397	15.5	D	G
DWC-067I-12.5						2.250	0.669	1.581	14.0	D	G
DWC-067I-13						2.500	0.724	1.776	13.3	E	H
DWC-067I-14						3.000	0.835	2.165	11.0	E	H
DWC-067I-14.5						3.250	0.935	2.315	9.2	F	H
DWC-067I-15	3.500	0.998	2.502	8.5	F	H					
DWC-072I-6	0.720	0.750	0.531	0.072	26.353	0.750	0.368	0.382	67.3	C	G
DWC-072I-7						0.875	0.365	0.510	48.0	C	G
DWC-072I-8						1.000	0.397	0.603	42.0	C	G
DWC-072I-9						1.250	0.448	0.802	35.0	D	H
DWC-072I-10						1.500	0.554	0.946	26.0	D	H
DWC-072I-11						1.750	0.628	1.122	22.0	D	H
DWC-072I-12						2.000	0.677	1.323	20.0	D	H
DWC-072I-12.5						2.250	0.779	1.471	17.0	D	H
DWC-072I-13						2.500	0.815	1.685	17.1	F	I
DWC-072I-13.5						2.750	0.927	1.823	14.0	F	I
DWC-072I-14						3.000	0.942	2.058	14.1	F	I
DWC-072I-15						3.500	1.150	2.350	10.5	G	J
DWC-072I-16	4.000	1.321	2.679	9.1	H	K					
DWC-081I-6	0.720	0.750	0.531	0.081	37.356	0.750	0.429	0.321	103.5	E	H
DWC-081I-7						0.875	0.470	0.405	84.7	E	I
DWC-081I-8						1.000	0.508	0.492	72.6	E	I
DWC-081I-9						1.250	0.587	0.663	55.9	E	I
DWC-081I-10						1.500	0.665	0.835	45.5	E	I
DWC-081I-11						1.750	0.744	1.006	38.3	F	J
DWC-081I-12						2.000	0.823	1.177	33.1	G	K
DWC-081I-12.5						2.250	0.855	1.395	27.5	H	L
DWC-081I-13						2.500	0.981	1.519	26.0	H	M
DWC-081I-13.5						2.750	1.015	1.735	22.2	H	M
DWC-081I-14						3.000	1.139	1.861	21.4	J	O
DWC-081I-15						3.500	1.273	2.227	17.0	K	P
DWC-081I-16	4.000	1.440	2.560	14.8	L	Q					
DWC-085I-7	0.720	0.750	0.534	0.085	53.433	0.875	0.411	0.464	113.7	E	H
DWC-085I-8						1.000	0.451	0.549	97.0	E	H
DWC-085I-9						1.250	0.534	0.716	74.5	E	H
DWC-085I-10						1.500	0.617	0.883	60.5	E	H
DWC-085I-11						1.750	0.701	1.049	51.0	F	J
DWC-085I-12						2.000	0.784	1.216	44.0	G	K
DWC-085I-12.5						2.250	0.867	1.383	38.7	H	L
DWC-085I-13						2.500	0.950	1.550	34.6	H	M
DWC-085I-13.5						2.750	1.033	1.717	31.2	I	N
DWC-085I-14						3.000	1.117	1.883	28.4	J	O
DWC-085I-15						3.500	1.283	2.217	24.2	K	P
DWC-085I-16						4.000	1.449	2.551	21.0	L	Q
DWC-095I-7	0.720	0.750	0.514	0.095	74.917	0.875	0.459	0.416	178.5	F	I
DWC-095I-8						1.000	0.507	0.493	150.9	F	I

COMPRESSION SPRINGS

Note: Wire Dia. up to .098" is Music Wire (MW); .105" and over is Oil Tempered Wire (OT). Stainless available up to .135" wire size. Above rates and loads are multiplied by .833 when using stainless. For prices from 1 to 100 see Price Index. Please inquire if you need a size not listed above.

STOCK COMPRESSION SPRINGS

Music Wire/Oil Tempered & Stainless (See Below)

Ends Squared and Ground Ends to be Square Within 3 Degrees of Axis

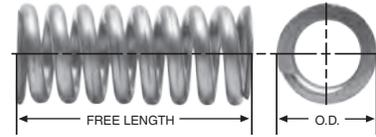

COMPRESSION SPRINGS

DIAMOND WIRE SPRING STOCK NO.	OUTSIDE DIAMETER	TO WORK IN HOLE DIA.	TO WORK OVER ROD DIA.	WIRE DIA.	APPROX. LOAD AT SOLID HT.	FREE LENGTH	SOLID HT.	TOTAL DEFLECTION	SPRING RATE	PRICE GROUP	
	IN.	IN.	IN.	IN.	LB.	IN.	IN.	IN.	LB./IN.	OT/MW	SS
DWC-095I-9	0.720	0.750	0.514	0.095	74.917	1.250	0.602	0.648	115.3	F	I
DWC-095I-10						1.500	0.698	0.802	93.4	F	J
DWC-095I-11						1.750	0.794	0.956	78.4	G	K
DWC-095I-12						2.000	0.890	1.110	67.6	H	L
DWC-095I-12.5						2.250	0.986	1.264	59.4	I	M
DWC-095I-13						2.500	1.082	1.418	52.9	I	N
DWC-095I-13.5						2.750	1.178	1.572	47.8	J	O
DWC-095I-14						3.000	1.274	1.726	43.5	K	P
DWC-095I-15						3.500	1.466	2.034	37.0	L	Q
DWC-095I-16	4.000	1.658	2.342	32.1	M	R					
DWC-105I-7	0.720	0.750	0.494	0.105	97.101	0.875	0.525	0.350	274.6	G	I
DWC-105I-8						1.000	0.583	0.417	231.1	G	I
DWC-105I-9						1.250	0.699	0.551	175.6	G	I
DWC-105I-10						1.500	0.815	0.685	141.5	G	J
DWC-105I-11						1.750	0.931	0.819	118.5	H	K
DWC-105I-12						2.000	1.047	0.953	102.0	I	L
DWC-105I-12.5						2.250	1.163	1.087	89.5	J	M
DWC-105I-13						2.500	1.279	1.221	79.8	J	N
DWC-105I-13.5						2.750	1.395	1.355	71.9	T	O
DWC-105I-14	3.000	1.511	1.489	65.5	L	P					
DWC-105I-15	3.500	1.743	1.757	55.5	M	Q					
DWC-105I-16	4.000	1.975	2.025	48.2	N	R					
DWC-112I-7	0.720	0.750	0.480	0.112	118.036	0.875	0.569	0.306	372.8	K	N
DWC-112I-8						1.000	0.631	0.369	312.8	K	N
DWC-112I-9						1.250	0.757	0.493	236.6	K	N
DWC-112I-10						1.500	0.882	0.618	190.2	K	N
DWC-112I-11						1.750	1.007	0.743	159.0	K	N
DWC-112I-12						2.000	1.133	0.867	136.7	K	N
DWC-112I-12.5						2.250	1.258	0.992	119.8	L	N
DWC-112I-13						2.500	1.383	1.117	106.6	L	O
DWC-112I-13.5						2.750	1.509	1.241	96.1	M	P
DWC-112I-14	3.000	1.634	1.366	87.4	M	P					
DWC-112I-15	3.500	1.885	1.615	74.1	N	Q					
DWC-112I-16	4.000	2.136	1.864	64.3	P	S					
DWC-135II-7	0.750	0.781	0.460	0.135	222.009	0.875	0.616	0.259	843.0	K	O
DWC-135II-8						1.000	0.686	0.314	698.6	K	O
DWC-135II-9						1.500	0.966	0.534	414.6	K	O
DWC-135II-11						1.750	1.106	0.644	344.6	K	O
DWC-135II-12						2.000	1.246	0.754	294.8	L	P
DWC-135II-12.5						2.250	1.386	0.864	257.5	L	P
DWC-135II-13						2.500	1.526	0.974	228.7	M	R
DWC-135II-14						3.000	1.805	1.195	186.8	O	T
DWC-135II-15						3.500	2.085	1.415	157.9	P	U
DWC-135II-15.5	3.750	2.225	1.525	146.5	P	U					
DWC-135II-16	4.000	2.365	1.635	136.7	R	U					
DWC-135IJ-7	0.813	0.844	0.523	0.135	174.174	0.875	0.609	0.266	643.3	K	O
DWC-135IJ-8						1.000	0.677	0.323	533.1	K	O

Note: Wire Dia. up to .098" is Music Wire (MW); .105" and over is Oil Tempered Wire (OT). Stainless available up to .135" wire size. Above rates and loads are multiplied by .833 when using stainless. For prices from 1 to 100 see Price Index. Please inquire if you need a size not listed above.

STOCK COMPRESSION SPRINGS

Music Wire/Oil Tempered & Stainless (See Below)

Ends Squared and Ground Ends to be Square Within 3 Degrees of Axis

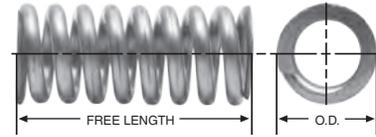

DIAMOND WIRE SPRING STOCK NO.	OUTSIDE DIAMETER	TO WORK IN HOLE DIA.	TO WORK OVER ROD DIA.	WIRE DIA.	APPROX. LOAD AT SOLID HT.	FREE LENGTH	SOLID HT.	TOTAL DEFLECTION	SPRING RATE	PRICE GROUP	
	IN.	IN.	IN.	IN.	LB.	IN.	IN.	IN.	LB./IN.	OT/MW	SS
DWC-135IJ-9	0.813	0.844	0.523	0.135	174.174	1.500	0.951	0.549	316.4	K	O
DWC-135IJ-11						1.750	1.088	0.662	262.9	K	O
DWC-135IJ-12						2.000	1.224	0.776	224.9	L	P
DWC-135IJ-12.5						2.250	1.361	0.889	196.5	L	P
DWC-135IJ-13						2.500	1.498	1.002	174.5	M	R
DWC-135IJ-14						3.000	1.772	1.228	142.5	O	T
DWC-135IJ-15						3.500	2.045	1.455	120.4	P	U
DWC-135IJ-15.5						3.750	2.182	1.568	111.8	P	U
DWC-135IJ-16	4.000	2.319	1.681	104.3	R	U					
DWC-162IJ-9.5	0.813	0.844	0.469	0.162	343.344	1.375	0.998	0.377	901.3	K	O
DWC-162IJ-10						1.500	1.077	0.423	805.4	K	O
DWC-162IJ-11						1.750	1.235	0.515	664.2	L	P
DWC-162IJ-12						2.000	1.393	0.607	565.1	M	R
DWC-162IJ-12.5						2.250	1.551	0.699	491.8	M	R
DWC-162IJ-13.5						2.750	1.867	0.883	390.4	O	T
DWC-162IJ-14						3.000	2.025	0.975	353.9	O	T
DWC-162IJ-14.5						3.250	2.183	1.067	323.7	O	T
DWC-162IJ-15	3.500	2.341	1.159	298.2	P	U					
DWC-050J-6	0.850	0.875	0.729	0.050	7.446	0.750	0.181	0.569	13.0	C	I
DWC-050J-7						0.875	0.195	0.680	10.9	C	I
DWC-050J-8						1.000	0.210	0.790	9.4	C	I
DWC-050J-9						1.250	0.237	1.013	7.3	C	I
DWC-050J-10						1.500	0.265	1.235	6.0	D	D
DWC-050J-12						2.000	0.320	1.680	4.4	D	K
DWC-050J-13						2.500	0.375	2.125	3.5	E	M
DWC-050J-14						3.000	0.431	2.569	2.9	E	O
DWC-050J-15	3.500	0.486	3.014	2.5	E	O					
DWC-050J-16	4.000	0.541	3.459	2.2	F	P					
DWC-055J-6	0.850	0.875	0.718	0.055	9.644	0.750	0.196	0.554	18.1	C	I
DWC-055J-7						0.875	0.218	0.657	15.0	C	I
DWC-055J-8						1.000	0.278	0.722	12.7	C	I
DWC-055J-9						1.250	0.271	0.979	9.8	C	I
DWC-055J-10						1.500	0.304	1.196	8.0	D	I
DWC-055J-11						1.750	0.330	1.420	6.5	D	J
DWC-055J-12						2.000	0.370	1.630	5.8	D	K
DWC-055J-13						2.500	0.437	2.063	4.5	E	M
DWC-055J-14	3.000	0.503	2.497	3.8	E	O					
DWC-055J-15	3.500	0.569	2.931	3.4	F	N					
DWC-055J-16	4.000	0.636	3.364	3.0	F	N					
DWC-068J-6	0.850	0.875	0.687	0.068	16.970	0.750	0.292	0.458	35.9	E	I
DWC-068J-7						0.875	0.317	0.558	29.8	E	I
DWC-068J-8						1.000	0.342	0.658	25.5	E	I
DWC-068J-9						1.250	0.391	0.859	19.8	E	I
DWC-068J-10						1.500	0.441	1.059	16.1	E	I
DWC-068J-11						1.750	0.490	1.260	13.6	F	J
DWC-068J-12						2.000	0.540	1.460	11.8	F	K
DWC-068J-13						2.500	0.639	1.861	9.3	H	M

COMPRESSION SPRINGS

Note: Wire Dia. up to .098" is Music Wire (MW); .105" and over is Oil Tempered Wire (OT). Stainless available up to .135" wire size. Above rates and loads are multiplied by .833 when using stainless. For prices from 1 to 100 see Price Index. Please inquire if you need a size not listed above.

STOCK COMPRESSION SPRINGS

Music Wire/Oil Tempered & Stainless (See Below)

Ends Squared and Ground Ends to be Square Within 3 Degrees of Axis

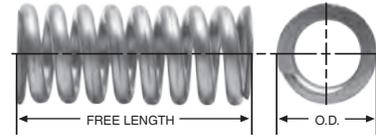

COMPRESSION SPRINGS

DIAMOND WIRE SPRING STOCK NO.	OUTSIDE DIAMETER	TO WORK IN HOLE DIA.	TO WORK OVER ROD DIA.	WIRE DIA.	APPROX. LOAD AT SOLID HT.	FREE LENGTH	SOLID HT.	TOTAL DEFLECTION	SPRING RATE	PRICE GROUP						
	IN.	IN.	IN.	IN.	LB.	IN.	IN.	IN.	LB./IN.	OT/MW	SS					
DWC-068J-14	0.850	0.875	0.687	0.068	16.970	3.000	0.739	2.261	7.7	I	M					
DWC-068J-15						3.500	0.832	2.668	6.3	I	O					
DWC-068J-16						4.000	0.934	3.066	5.5	I	O					
DWC-074J-7	0.850	0.875	0.656	0.074	21.037	0.875	0.355	0.520	40.1	E	I					
DWC-074J-8						1.000	0.384	0.616	34.2	E	I					
DWC-074J-9						1.250	0.443	0.807	26.5	E	I					
DWC-074J-10						1.500	0.501	0.999	21.6	E	K					
DWC-074J-11						1.750	0.540	1.210	17.4	F	K					
DWC-074J-12						2.000	0.618	1.382	15.8	F	K					
DWC-074J-13						2.500	0.735	1.765	12.4	H	M					
DWC-074J-13.5						2.750	0.867	1.883	11.3	H	M					
DWC-074J-14						3.000	0.852	2.148	10.2	I	N					
DWC-074J-15						3.500	1.073	2.427	8.7	I	N					
DWC-081J-6	0.850	0.875	0.656	0.081	27.776	0.750	0.365	0.385	67.7	E	I					
DWC-081J-7						0.875	0.400	0.475	55.8	E	I					
DWC-081J-8						1.000	0.435	0.565	47.5	E	I					
DWC-081J-9						1.250	0.504	0.746	36.6	E	I					
DWC-081J-9.5						1.375	0.490	0.885	34.0	E	I					
DWC-081J-10						1.500	0.573	0.927	29.7	E	I					
DWC-081J-11						1.750	0.642	1.108	25.1	E	J					
DWC-081J-12						2.000	0.712	1.288	21.6	F	K					
DWC-081J-12.5						2.250	0.723	1.527	19.5	F	K					
DWC-081J-13						2.500	0.850	1.650	17.0	H	M					
DWC-081J-13.5						2.750	0.865	1.885	15.5	H	M					
DWC-081J-14						3.000	0.989	2.011	14.0	I	O					
DWC-081J-15						3.500	1.083	2.417	12.0	J	O					
DWC-085J-6						0.850	0.875	0.656	0.085	32.326	0.750	0.388	0.362	81.3	E	I
DWC-085J-7											0.875	0.426	0.449	66.9	E	I
DWC-085J-8	1.000	0.463	0.537	56.8	E						I					
DWC-085J-9	1.250	0.539	0.711	43.6	E						I					
DWC-085J-9.5	1.375	0.537	0.838	42.0	E						I					
DWC-085J-10	1.500	0.615	0.885	35.4	E						I					
DWC-085J-11	1.750	0.690	1.060	29.8	E						J					
DWC-085J-12	2.000	0.766	1.234	25.8	F						K					
DWC-085J-12.5	2.250	0.821	1.429	24.0	F						K					
DWC-085J-13	2.500	0.917	1.583	20.2	H						M					
DWC-085J-13.5	2.750	0.961	1.789	19.5	H						M					
DWC-085J-14	3.000	1.068	1.932	16.7	I						O					
DWC-085J-15	3.500	1.190	2.310	15.0	I						O					
DWC-085J-16	4.000	1.343	2.657	13.0	J						P					
DWC-092J-7	0.850	0.875	0.625	0.092	38.729						0.875	0.471	0.404	90.1	J	M
DWC-092J-8											1.000	0.513	0.487	76.9	J	M
DWC-092J-9						1.250	0.600	0.650	58.8	J	N					
DWC-092J-10						1.500	0.686	0.814	47.7	J	N					
DWC-092J-11						1.750	0.773	0.977	40.0	J	N					
DWC-092J-12						2.000	0.860	1.140	34.5	J	N					
DWC-092J-12.5						2.250	0.910	1.340	31.0	K	O					

Note: Wire Dia. up to .098" is Music Wire (MW); .105" and over is Oil Tempered Wire (OT). Stainless available up to .135" wire size. Above rates and loads are multiplied by .833 when using stainless. For prices from 1 to 100 see Price Index. Please inquire if you need a size not listed above.

STOCK COMPRESSION SPRINGS

Music Wire/Oil Tempered & Stainless (See Below)

Ends Squared and Ground Ends to be Square Within 3 Degrees of Axis

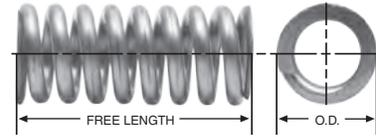

DIAMOND WIRE SPRING STOCK NO.	OUTSIDE DIAMETER	TO WORK IN HOLE DIA.	TO WORK OVER ROD DIA.	WIRE DIA.	APPROX. LOAD AT SOLID HT.	FREE LENGTH	SOLID HT.	TOTAL DEFLECTION	SPRING RATE	PRICE GROUP	
	IN.	IN.	IN.	IN.	LB.	IN.	IN.	IN.	LB./IN.	OT/MW	SS
DWC-092J-13	0.850	0.875	0.625	0.092	38.729	2.500	1.033	1.467	27.1	K	O
DWC-092J-13.5						2.750	1.080	1.670	25.0	K	O
DWC-092J-14						3.000	1.207	1.793	22.3	L	P
DWC-098J-8	0.850	0.875	0.625	0.098	46.604	1.000	0.555	0.445	98.7	J	N
DWC-098J-9						1.250	0.651	0.599	75.3	J	N
DWC-098J-10						1.500	0.747	0.753	60.8	J	N
DWC-098J-11						1.750	0.843	0.907	51.1	J	N
DWC-098J-12						2.000	0.940	1.060	44.0	J	N
DWC-098J-12.5						2.250	1.010	1.240	40.0	K	O
DWC-098J-13						2.500	1.132	1.368	34.4	K	O
DWC-098J-13.5						2.750	1.220	1.530	32.5	L	P
DWC-098J-14						3.000	1.325	1.675	28.3	L	P
DWC-098J-15						3.500	1.472	2.028	25.5	M	Q
DWC-100J-8	0.850	0.875	0.629	0.100	62.857	1.000	0.501	0.499	124.7	K	N
DWC-100J-9						1.250	0.592	0.658	95.0	K	N
DWC-100J-10						1.500	0.683	0.817	76.7	K	N
DWC-100J-11						1.750	0.774	0.976	64.4	K	N
DWC-100J-12						2.000	0.865	1.135	55.4	K	N
DWC-100J-12.5						2.250	0.955	1.295	48.7	L	N
DWC-100J-13						2.500	1.046	1.454	43.4	L	O
DWC-100J-13.5						2.750	1.137	1.613	39.1	M	P
DWC-100J-14						3.000	1.228	1.772	35.6	M	P
DWC-100J-15						3.500	1.410	2.090	30.2	M	Q
DWC-092JJ-7	0.875	0.906	0.671	0.092	37.607	0.875	0.437	0.438	85.4	J	M
DWC-092JJ-8						1.000	0.482	0.518	72.3	J	N
DWC-092JJ-10						1.500	0.662	0.838	44.8	J	N
DWC-092JJ-11						1.750	0.752	0.998	37.7	J	N
DWC-092JJ-12						2.000	0.842	1.158	32.5	K	O
DWC-092JJ-13						2.500	1.021	1.479	25.5	K	O
DWC-092JJ-13.5						2.750	1.111	1.639	23.0	L	P
DWC-092JJ-15						3.500	1.381	2.119	17.8	N	Q
DWC-092JJ-16	4.000	1.561	2.439	15.5	Q	U					
DWC-120JJ-10	0.875	0.906	0.614	0.120	103.667	1.500	0.815	0.685	150.6	K	O
DWC-120JJ-12						2.000	1.041	0.959	107.8	L	P
DWC-120JJ-12.5						2.250	1.153	1.097	94.4	L	P
DWC-120JJ-13						2.500	1.266	1.234	84.0	M	Q
DWC-120JJ-14						3.000	1.492	1.508	68.8	N	S
DWC-120JJ-15						3.500	1.717	1.783	58.2	P	T
DWC-120JJ-16						4.000	1.943	2.057	50.5	P	U
DWC-120JJ-17						4.500	2.168	2.332	44.5	R	V
DWC-120JJ-18						5.000	2.394	2.606	39.9	R	V
DWC-120JJ-18.5						5.500	2.619	2.881	36.1	S	U
DWC-148JJ-8	0.875	0.906	0.559	0.148	213.883	1.000	0.698	0.302	695.2	K	O
DWC-148JJ-10						1.500	0.977	0.523	406.4	K	O
DWC-148JJ-12						2.000	1.257	0.743	287.2	L	P
DWC-148JJ-12.5						2.250	1.397	0.853	250.4	L	P
DWC-148JJ-13						2.500	1.537	0.963	222.0	M	Q

Note: Wire Dia. up to .098" is Music Wire (MW); .105" and over is Oil Tempered Wire (OT). Stainless available up to .135" wire size. Above rates and loads are multiplied by .833 when using stainless. For prices from 1 to 100 see Price Index. Please inquire if you need a size not listed above.

STOCK COMPRESSION SPRINGS

Music Wire/Oil Tempered & Stainless (See Below)

Ends Squared and Ground Ends to be Square Within 3 Degrees of Axis

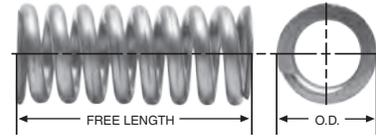

COMPRESSION SPRINGS

DIAMOND WIRE SPRING STOCK NO.	OUTSIDE DIAMETER	TO WORK IN HOLE DIA.	TO WORK OVER ROD DIA.	WIRE DIA.	APPROX. LOAD AT SOLID HT.	FREE LENGTH	SOLID HT.	TOTAL DEFLECTION	SPRING RATE	PRICE GROUP	
	IN.	IN.	IN.	IN.	LB.	IN.	IN.	IN.	LB./IN.	OT/MW	SS
DWC-148JJ-13.5	0.875	0.906	0.559	0.148	213.883	2.750	1.676	1.074	199.4	M	Q
DWC-148JJ-14						3.000	1.816	1.184	181.0	O	S
DWC-148JJ-15						3.500	2.096	1.404	152.7	P	T
DWC-148JJ-16						4.000	2.375	1.625	132.1	R	V
DWC-148JJ-17						4.500	2.655	1.845	116.4	R	V
DWC-148JJ-18						5.000	2.934	2.066	104.0	R	V
DWC-148JJ-18.5						5.500	3.214	2.286	94.0	S	U
DWC-148JJ-19						6.000	3.493	2.507	85.8	T	U
DWC-063K-6	0.975	1.000	0.823	0.063	13.869	0.750	0.210	0.540	25.6	K	O
DWC-063K-8						1.000	0.245	0.755	18.3	K	O
DWC-063K-9						1.250	0.276	0.974	14.2	K	O
DWC-063K-10						1.500	0.307	1.193	11.6	K	O
DWC-063K-11						1.750	0.339	1.411	9.9	K	O
DWC-063K-12						2.000	0.370	1.630	8.5	K	O
DWC-063K-12.5						2.250	0.401	1.849	7.5	M	Q
DWC-063K-13						2.500	0.432	2.068	6.7	M	Q
DWC-063K-13.5						2.750	0.463	2.287	6.1	M	Q
DWC-063K-14						3.000	0.495	2.505	5.6	N	T
DWC-063K-15						3.500	0.557	2.943	4.7	P	T
DWC-063K-16						4.000	0.619	3.381	4.1	Q	T
DWC-074K-6	0.975	1.000	0.781	0.074	19.193	0.750	0.295	0.455	39.8	K	O
DWC-074K-7						0.875	0.317	0.558	33.0	K	O
DWC-074K-8						1.000	0.340	0.660	28.1	K	O
DWC-074K-9						1.250	0.386	0.864	21.7	K	O
DWC-074K-10						1.500	0.431	1.069	17.7	K	O
DWC-074K-11						1.750	0.423	1.327	14.9	K	O
DWC-074K-12						2.000	0.522	1.478	12.9	K	O
DWC-074K-12.5						2.250	0.507	1.743	11.4	K	O
DWC-074K-13						2.500	0.613	1.887	10.2	M	Q
DWC-074K-13.5						2.750	0.590	2.160	9.2	M	Q
DWC-074K-14						3.000	0.704	2.296	8.4	N	T
DWC-074K-15						3.500	0.795	2.705	7.1	P	T
DWC-074K-16	4.000	0.886	3.114	6.2	Q	T					
DWC-080K-6	0.975	1.000	0.789	0.080	29.716	0.750	0.270	0.480	60.5	K	O
DWC-080K-8						1.000	0.330	0.670	43.6	K	O
DWC-080K-9						1.250	0.376	0.874	33.9	K	O
DWC-080K-10						1.500	0.423	1.077	27.6	K	O
DWC-080K-11						1.750	0.470	1.280	23.2	K	O
DWC-080K-12						2.000	0.517	1.483	20.1	K	O
DWC-080K-12.5						2.250	0.565	1.685	17.7	M	Q
DWC-080K-13						2.500	0.612	1.888	15.8	M	Q
DWC-080K-13.5						2.750	0.659	2.091	14.3	N	T
DWC-080K-14						3.000	0.706	2.294	13.0	N	T
DWC-080K-15						3.500	0.800	2.700	11.1	P	T
DWC-080K-16						4.000	0.893	3.107	9.7	P	T
DWC-085K-7	0.975	1.000	0.781	0.085	30.024	0.875	0.381	0.494	53.8	K	O
DWC-085K-8						1.000	0.411	0.589	45.7	K	O

Note: Wire Dia. up to .098" is Music Wire (MW); .105" and over is Oil Tempered Wire (OT). Stainless available up to .135" wire size. Above rates and loads are multiplied by .833 when using stainless. For prices from 1 to 100 see Price Index. Please inquire if you need a size not listed above.

STOCK COMPRESSION SPRINGS

Music Wire/Oil Tempered & Stainless (See Below)

Ends Squared and Ground Ends to be Square Within 3 Degrees of Axis

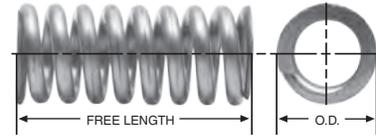

DIAMOND WIRE SPRING STOCK NO.	OUTSIDE DIAMETER	TO WORK IN HOLE DIA.	TO WORK OVER ROD DIA.	WIRE DIA.	APPROX. LOAD AT SOLID HT.	FREE LENGTH	SOLID HT.	TOTAL DEFLECTION	SPRING RATE	PRICE GROUP	
	IN.	IN.	IN.	IN.	LB.	IN.	IN.	IN.	LB./IN.	OT/MW	SS
DWC-085K-9	0.975	1.000	0.781	0.085	30.024	1.250	0.470	0.780	35.1	K	O
DWC-085K-10						1.500	0.530	0.970	28.5	K	O
DWC-085K-11						1.750	0.488	1.262	30.2	K	O
DWC-085K-12						2.000	0.649	1.351	20.7	K	O
DWC-085K-12.5						2.250	0.589	1.661	22.9	M	Q
DWC-085K-13						2.500	0.769	1.731	16.3	M	Q
DWC-085K-13.5						2.750	0.690	2.060	18.5	N	Y
DWC-085K-14						3.000	0.888	2.112	13.4	N	T
DWC-085K-15						3.500	1.007	2.493	11.4	P	T
DWC-092K-7	0.975	1.000	0.750	0.092	34.000	0.875	0.421	0.454	72.0	K	O
DWC-092K-8						1.000	0.456	0.544	61.0	K	O
DWC-092K-9						1.250	0.525	0.725	46.7	K	O
DWC-092K-10						1.500	0.594	0.906	37.8	K	O
DWC-092K-12						2.000	0.732	1.268	27.4	K	O
DWC-092K-13						2.500	0.871	1.629	21.5	M	Q
DWC-092K-14						3.000	1.009	1.991	17.7	N	T
DWC-092K-15						3.500	1.147	2.353	15.0	P	T
DWC-092K-16						4.000	1.286	2.714	13.0	Q	U
DWC-096K-7	0.975	1.000	0.750	0.096	39.946	0.875	0.444	0.431	84.6	K	O
DWC-096K-8						1.000	0.481	0.519	71.5	K	O
DWC-096K-9						1.250	0.556	0.694	54.6	K	O
DWC-096K-10						1.500	0.631	0.869	44.2	K	O
DWC-096K-11						1.750	0.618	1.132	39.7	K	O
DWC-096K-12						2.000	0.780	1.220	31.9	K	O
DWC-096K-12.5						2.250	0.751	1.499	30.1	M	Q
DWC-096K-13						2.500	0.930	1.570	25.0	M	Q
DWC-096K-13.5						2.750	0.884	1.866	24.3	N	T
DWC-096K-14	3.000	1.079	1.921	20.6	N	T					
DWC-096K-15	3.500	1.228	2.272	17.5	P	T					
DWC-105K-7	0.975	1.000	0.718	0.105	50.146	0.875	0.496	0.379	119.1	K	O
DWC-105K-8						1.000	0.538	0.462	101.0	K	O
DWC-105K-9						1.250	0.626	0.624	76.7	K	O
DWC-105K-10						1.500	0.713	0.787	61.8	K	O
DWC-105K-11						1.750	0.745	1.005	57.0	K	O
DWC-105K-11						1.750	0.800	0.950	51.8	K	O
DWC-105K-12						2.000	0.888	1.112	44.6	L	P
DWC-105K-12.5						2.250	0.905	1.345	43.0	M	Q
DWC-105K-13						2.500	1.062	1.438	34.8	M	Q
DWC-105K-13.5						2.750	1.080	1.670	34.0	N	T
DWC-105K-14						3.000	1.237	1.763	28.6	N	T
DWC-105K-15						3.500	1.411	2.089	24.3	P	T
DWC-105K-16						4.000	1.586	2.414	21.1	Q	U
DWC-112K-7						0.975	1.000	0.718	0.112	59.224	0.875
DWC-112K-8	1.000	0.581	0.419	130.8	K						O
DWC-112K-9	1.250	0.679	0.571	98.9	K						O
DWC-112K-10	1.500	0.776	0.724	79.5	K						O
DWC-112K-11	1.750	0.845	0.905	71.0	K						O

COMPRESSION SPRINGS

Note: Wire Dia. up to .098" is Music Wire (MW); .105" and over is Oil Tempered Wire (OT). Stainless available up to .135" wire size. Above rates and loads are multiplied by .833 when using stainless. For prices from 1 to 100 see Price Index. Please inquire if you need a size not listed above.

STOCK COMPRESSION SPRINGS

Music Wire/Oil Tempered & Stainless (See Below)

Ends Squared and Ground Ends to be Square Within 3 Degrees of Axis

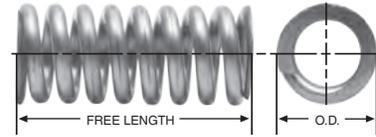

COMPRESSION SPRINGS

DIAMOND WIRE SPRING STOCK NO.	OUTSIDE DIAMETER	TO WORK IN HOLE DIA.	TO WORK OVER ROD DIA.	WIRE DIA.	APPROX. LOAD AT SOLID HT.	FREE LENGTH	SOLID HT.	TOTAL DEFLECTION	SPRING RATE	PRICE GROUP	
	IN.	IN.	IN.	IN.	LB.	IN.	IN.	IN.	LB./IN.	OT/MW	SS
DWC-112K-12	0.975	1.000	0.718	0.112	59.224	2.000	0.970	1.030	57.1	L	P
DWC-112K-12.5						2.250	1.035	1.215	54.0	M	Q
DWC-112K-13						2.500	1.164	1.336	44.6	M	Q
DWC-112K-13.5						2.750	1.237	1.513	43.0	N	S
DWC-112K-14						3.000	1.358	1.642	36.6	N	S
DWC-112K-15						3.500	1.553	1.947	31.0	P	T
DWC-112K-16	4.000	1.634	2.366	28.6	Q	U					
DWC-120K-10	0.975	1.000	0.709	0.120	80.049	1.500	0.785	0.715	113.7	K	O
DWC-120K-11						1.750	0.905	0.845	95.0	K	O
DWC-120K-12						2.000	1.015	0.985	82.0	L	P
DWC-120K-12.5						2.250	1.133	1.117	71.0	M	Q
DWC-120K-13						2.500	1.254	1.246	64.0	M	Q
DWC-120K-14						3.000	1.456	1.544	52.0	O	T
DWC-120K-15	3.500	1.685	1.815	44.0	P	U					
DWC-120K-16	4.000	1.925	2.075	38.0	P	U					
DWC-125K-7	0.975	1.000	0.687	0.125	74.000	0.875	0.602	0.273	246.6	K	O
DWC-125K-8						1.000	0.657	0.343	207.2	K	O
DWC-125K-9						1.250	0.772	0.478	155.4	K	O
DWC-125K-10						1.500	0.887	0.613	124.3	K	O
DWC-125K-11						1.750	1.002	0.748	103.6	K	O
DWC-125K-12						2.000	1.117	0.883	88.8	L	P
DWC-125K-12.5						2.250	1.092	1.158	86.4	M	R
DWC-125K-13						2.500	1.347	1.153	69.1	M	R
DWC-125K-14						3.000	1.577	1.423	56.5	O	T
DWC-125K-15						3.500	1.807	1.693	47.8	P	U
DWC-125K-16	4.000	2.037	1.963	41.4	R	U					
DWC-135K-9	0.975	1.000	0.656	0.135	102.493	1.250	0.776	0.474	215.0	K	O
DWC-135K-10						1.500	0.911	0.589	169.0	K	O
DWC-135K-11						1.750	1.012	0.738	146.0	K	O
DWC-135K-12						2.000	1.147	0.853	124.0	L	P
DWC-135K-12.5						2.250	1.298	0.952	111.8	M	R
DWC-135K-13						2.500	1.417	1.083	95.0	M	R
DWC-135K-14						3.000	1.687	1.313	77.0	O	T
DWC-135K-15						3.500	1.957	1.543	64.0	P	U
DWC-135K-16	4.000	2.194	1.806	56.0	R	U					
DWC-148K-9	0.975	1.000	0.625	0.148	131.000	1.250	0.851	0.399	325.0	K	O
DWC-148K-10						1.500	1.000	0.500	257.0	K	O
DWC-148K-11						1.750	1.147	0.603	212.0	K	O
DWC-148K-12						2.000	1.295	0.705	181.0	L	P
DWC-148K-13						2.500	1.554	0.946	143.0	M	Q
DWC-148K-14						3.000	1.850	1.150	116.0	O	S
DWC-148K-15						3.500	2.146	1.354	98.0	P	T
DWC-148K-16						4.000	2.442	1.558	84.0	R	U
DWC-148K-18	5.000	3.034	1.966	66.0	R	U					
DWC-162K-9	0.975	1.000	0.593	0.162	158.000	1.250	0.931	0.319	491.0	K	O
DWC-162K-10						1.500	1.093	0.407	388.0	K	O
DWC-162K-11						1.750	1.255	0.495	320.0	L	P

Note: Wire Dia. up to .098" is Music Wire (MW); .105" and over is Oil Tempered Wire (OT). Stainless available up to .135" wire size. Above rates and loads are multiplied by .833 when using stainless. For prices from 1 to 100 see Price Index. Please inquire if you need a size not listed above.

STOCK COMPRESSION SPRINGS

Music Wire/Oil Tempered & Stainless (See Below)

Ends Squared and Ground Ends to be Square Within 3 Degrees of Axis

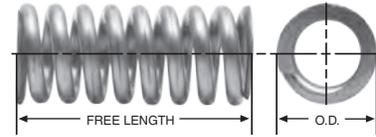

DIAMOND WIRE SPRING STOCK NO.	OUTSIDE DIAMETER	TO WORK IN HOLE DIA.	TO WORK OVER ROD DIA.	WIRE DIA.	APPROX. LOAD AT SOLID HT.	FREE LENGTH	SOLID HT.	TOTAL DEFLECTION	SPRING RATE	PRICE GROUP	
	IN.	IN.	IN.	IN.	LB.	IN.	IN.	IN.	LB./IN.	OT/MW	SS
DWC-162K-12	0.975	1.000	0.593	0.162	158.000	2.000	1.417	0.583	273.0	M	Q
DWC-162K-13						2.500	1.741	0.759	211.0	O	S
DWC-162K-14						3.000	2.065	0.935	171.0	O	S
DWC-162K-15						3.500	2.390	1.110	145.0	P	T
DWC-162K-16						4.000	2.713	1.287	125.0	R	U
DWC-162K-18						5.000	3.360	1.640	98.0	R	U
DWC-187K-9	0.975	1.000	0.562	0.187	227.000	1.250	1.028	0.222	1026.0	K	P
DWC-187K-10						1.500	1.215	0.285	798.0	L	S
DWC-187K-11						1.750	1.402	0.348	653.0	L	S
DWC-187K-12						2.000	1.590	0.410	553.0	M	W
DWC-187K-13						2.500	1.963	0.537	422.0	O	X
DWC-187K-14						3.000	2.337	0.663	342.0	O	X
DWC-187K-15						3.500	2.711	0.789	287.0	P	X
DWC-187K-16						4.000	3.085	0.915	248.0	R	Z
DWC-187K-18	5.000	3.835	1.165	194.0	R	Z					
DWC-085L-7	1.100	1.125	0.875	0.085	25.000	0.875	0.348	0.527	45.1	K	O
DWC-085L-8						1.000	0.372	0.628	38.3	K	O
DWC-085L-9						1.250	0.420	0.830	29.5	K	O
DWC-085L-10						1.500	0.467	1.033	23.9	K	O
DWC-085L-12						2.000	0.563	1.437	17.4	K	O
DWC-085L-13						2.500	0.659	1.841	13.7	M	Q
DWC-085L-14						3.000	0.755	2.245	11.2	N	T
DWC-085L-15						3.500	0.851	2.649	9.6	P	T
DWC-085L-16	4.000	0.947	3.053	8.3	P	T					
DWC-096L-7	1.100	1.125	0.875	0.096	34.000	0.875	0.406	0.469	69.8	K	O
DWC-096L-8						1.000	0.436	0.564	59.0	K	O
DWC-096L-9						1.250	0.497	0.753	45.1	K	O
DWC-096L-10						1.500	0.558	0.942	36.5	K	O
DWC-096L-12						2.000	0.679	1.321	26.4	K	O
DWC-096L-13						2.500	0.800	1.700	20.7	M	Q
DWC-096L-14						3.000	0.922	2.078	17.0	N	T
DWC-096L-15						3.500	1.043	2.457	14.4	P	T
DWC-096L-16	4.000	1.165	2.835	12.5	P	T					
DWC-105L-7	1.100	1.125	0.843	0.105	43.000	0.875	0.453	0.422	97.7	J	M
DWC-105L-8						1.000	0.489	0.511	82.2	J	N
DWC-105L-9						1.250	0.561	0.689	62.5	J	N
DWC-105L-10						1.500	0.632	0.868	50.4	J	N
DWC-105L-12						2.000	0.776	1.224	36.3	L	P
DWC-105L-13						2.500	0.919	1.581	28.4	M	R
DWC-105L-14						3.000	1.062	1.938	23.3	O	T
DWC-105L-15						3.500	1.206	2.294	19.7	P	U
DWC-112L-7	1.100	1.125	0.843	0.112	51.000	0.875	0.489	0.386	125.5	J	N
DWC-112L-8						1.000	0.530	0.470	105.3	J	N
DWC-112L-9						1.250	0.610	0.640	79.6	J	N
DWC-112L-10						1.500	0.690	0.810	64.0	J	N
DWC-112L-11						1.750	0.771	0.979	53.5	K	O
DWC-112L-12						2.000	0.851	1.149	46.0	L	P

COMPRESSION SPRINGS

Note: Wire Dia. up to .098" is Music Wire (MW); .105" and over is Oil Tempered Wire (OT). Stainless available up to .135" wire size. Above rates and loads are multiplied by .833 when using stainless. For prices from 1 to 100 see Price Index. Please inquire if you need a size not listed above.

STOCK COMPRESSION SPRINGS

Music Wire/Oil Tempered & Stainless (See Below)

Ends Squared and Ground Ends to be Square Within 3 Degrees of Axis

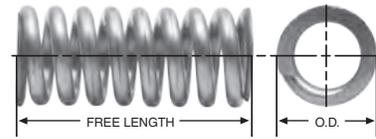

COMPRESSION SPRINGS

DIAMOND WIRE SPRING STOCK NO.	OUTSIDE DIAMETER	TO WORK IN HOLE DIA.	TO WORK OVER ROD DIA.	WIRE DIA.	APPROX. LOAD AT SOLID HT.	FREE LENGTH	SOLID HT.	TOTAL DEFLECTION	SPRING RATE	PRICE GROUP	
	IN.	IN.	IN.	IN.	LB.	IN.	IN.	IN.	LB./IN.	OT/MW	SS
DWC-112L-13	1.100	1.125	0.843	0.112	51.000	2.500	1.012	1.488	35.9	M	R
DWC-112L-14						3.000	1.173	1.827	29.4	O	T
DWC-112L-15						3.500	1.333	2.167	24.9	P	U
DWC-112L-16						4.000	1.494	2.506	21.6	R	U
DWC-125L-7	1.100	1.125	0.812	0.125	68.000	0.875	0.556	0.319	194.3	L	P
DWC-125L-8						1.000	0.603	0.397	163.2	L	P
DWC-125L-9						1.250	0.699	0.551	122.4	L	P
DWC-125L-10						1.500	0.796	0.704	97.9	L	P
DWC-125L-11						1.750	0.893	0.857	81.6	L	P
DWC-125L-12						2.000	0.989	1.011	69.9	M	Q
DWC-125L-13						2.500	1.183	1.317	54.4	N	R
DWC-125L-14						3.000	1.376	1.624	44.5	O	S
DWC-125L-15						3.500	1.569	1.931	37.7	P	T
DWC-125L-16						4.000	1.763	2.237	32.6	Q	U
DWC-135L-10	1.100	1.125	0.812	0.135	86.000	1.500	0.874	0.626	133.7	P	T
DWC-135L-12						2.000	1.092	0.908	95.1	P	T
DWC-135L-13						2.500	1.310	1.190	73.8	P	U
DWC-135L-14						3.000	1.528	1.472	60.3	Q	U
DWC-135L-15						3.500	1.746	1.754	50.9	Q	U
DWC-135L-16	4.000	1.964	2.036	44.1	T	U					
DWC-148L-10	1.100	1.125	0.750	0.148	104.000	1.500	0.925	0.575	188.0	M	
DWC-148L-12						2.000	1.221	0.779	128.0	M	
DWC-148L-13						2.500	1.480	1.020	100.0	N	
DWC-148L-14						3.000	1.739	1.261	82.0	P	
DWC-148L-15						3.500	1.998	1.502	70.0	Q	
DWC-148L-16						4.000	2.257	1.743	60.0	S	
DWC-148L-18						5.000	2.812	2.188	47.0	S	
DWC-162L-10	1.100	1.125	0.718	0.162	143.000	1.500	1.012	0.488	282.0	M	
DWC-162L-12						2.000	1.296	0.704	200.0	N	
DWC-162L-13						2.500	1.580	0.920	155.0	O	
DWC-162L-14						3.000	1.863	1.137	126.0	P	
DWC-162L-15						3.500	2.146	1.354	106.0	Q	
DWC-162L-16						4.000	2.430	1.570	92.0	S	
DWC-162L-18						5.000	3.037	1.963	72.0	S	
DWC-187L-10	1.100	1.125	0.687	0.187	222.000	1.500	1.122	0.378	577.0	N	
DWC-187L-12						2.000	1.449	0.551	402.0	N	
DWC-187L-13						2.500	1.776	0.724	308.0	O	
DWC-187L-14						3.000	2.104	0.896	250.0	P	
DWC-187L-15						3.500	2.431	1.069	210.0	Q	
DWC-187L-16						4.000	2.785	1.215	181.0	S	
DWC-187L-18						5.000	3.413	1.587	142.0	T	
DWC-096LM-8	1.187	1.218	0.937	0.096	33.000	1.000	0.366	0.634	51.9	K	O
DWC-096LM-10						1.500	0.474	1.026	32.1	K	O
DWC-096LM-12						2.000	0.581	1.419	23.2	K	O
DWC-096LM-13						2.500	0.688	1.812	18.2	M	Q
DWC-096LM-14						3.000	0.796	2.204	15.0	N	T
DWC-096LM-15						3.500	0.903	2.597	12.7	P	T

Note: Wire Dia. up to .098" is Music Wire (MW); .105" and over is Oil Tempered Wire (OT). Stainless available up to .135" wire size. Above rates and loads are multiplied by .833 when using stainless. For prices from 1 to 100 see Price Index. Please inquire if you need a size not listed above.

STOCK COMPRESSION SPRINGS

Music Wire/Oil Tempered & Stainless (See Below)

Ends Squared and Ground Ends to be Square Within 3 Degrees of Axis

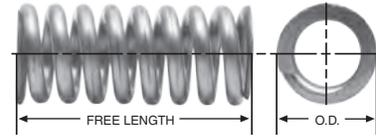

DIAMOND WIRE SPRING STOCK NO.	OUTSIDE DIAMETER	TO WORK IN HOLE DIA.	TO WORK OVER ROD DIA.	WIRE DIA.	APPROX. LOAD AT SOLID HT.	FREE LENGTH	SOLID HT.	TOTAL DEFLECTION	SPRING RATE	PRICE GROUP	
	IN.	IN.	IN.	IN.	LB.	IN.	IN.	IN.	LB./IN.	OT/MW	SS
DWC-096LM-16	1.187	1.218	0.937	0.096	33.000	4.000	1.011	2.989	11.0	P	T
DWC-096LM-17						4.500	1.119	3.381	9.7	Q	U
DWC-096LM-18						5.000	1.226	3.774	8.7	Q	U
DWC-105LM-8	1.187	1.218	0.937	0.105	48.000	1.000	0.394	0.606	78.8	K	O
DWC-105LM-10						1.500	0.499	1.001	50.1	K	O
DWC-105LM-12						2.000	0.630	1.370	34.5	M	Q
DWC-105LM-13						2.500	0.735	1.765	27.5	M	Q
DWC-105LM-14						3.000	0.866	2.134	22.1	O	T
DWC-105LM-15						3.500	0.971	2.529	19.0	P	U
DWC-105LM-16						4.000	1.102	2.898	16.2	P	U
DWC-105LM-17						4.500	1.223	3.277	14.3	R	U
DWC-105LM-18						5.000	1.340	3.660	12.8	S	U
DWC-112LM-8	1.187	1.218	0.875	0.112	52.000	1.000	0.442	0.558	93.4	L	P
DWC-112LM-10						1.500	0.584	0.916	56.7	L	P
DWC-112LM-12						2.000	0.724	1.276	40.8	M	Q
DWC-112LM-13						2.500	0.865	1.635	31.8	N	S
DWC-112LM-14						3.000	1.006	1.994	26.1	O	T
DWC-112LM-15						3.500	1.146	2.354	22.1	P	U
DWC-112LM-16						4.000	1.287	2.713	19.2	R	U
DWC-112LM-17						4.500	1.428	3.072	16.9	S	U
DWC-112LM-18						5.000	1.568	3.432	15.2	T	U
DWC-125LM-8	1.187	1.218	0.875	0.125	73.000	1.000	0.500	0.500	146.5	L	P
DWC-125LM-10						1.500	0.672	0.828	86.8	L	P
DWC-125LM-12						2.000	0.843	1.157	61.7	M	Q
DWC-125LM-13						2.500	1.000	1.500	48.8	N	S
DWC-125LM-14						3.000	1.156	1.844	40.4	O	T
DWC-125LM-15						3.500	1.343	2.157	33.5	P	U
DWC-125LM-16						4.000	1.500	2.500	29.3	R	U
DWC-125LM-17						4.500	1.666	2.834	25.9	S	U
DWC-125LM-18						5.000	1.833	3.167	23.1	T	U
DWC-135LM-8	1.187	1.218	0.843	0.135	88.000	1.000	0.551	0.449	197.2	P	R
DWC-135LM-10						1.500	0.744	0.756	117.2	P	R
DWC-135LM-12						2.000	0.936	1.064	83.2	P	R
DWC-135LM-13						2.500	1.127	1.373	64.6	P	S
DWC-135LM-14						3.000	1.320	1.680	52.7	Q	U
DWC-135LM-15						3.500	1.512	1.988	44.6	Q	U
DWC-135LM-16						4.000	1.705	2.295	38.6	T	U
DWC-135LM-17						4.500	1.897	2.603	34.0	T	U
DWC-135LM-18						5.000	2.090	2.910	30.4	T	U
DWC-148LM-8	1.187	1.218	0.843	0.148	125.000	1.000	0.592	0.408	307.5	L	
DWC-148LM-10						1.500	0.814	0.686	175.6	M	
DWC-148LM-12						2.000	1.017	0.983	126.1	M	
DWC-148LM-13						2.500	1.221	1.279	98.4	N	
DWC-148LM-14						3.000	1.443	1.557	79.3	P	
DWC-148LM-15						3.500	1.628	1.872	68.3	Q	
DWC-148LM-16						4.000	1.850	2.150	58.6	S	

COMPRESSION SPRINGS

Note: Wire Dia. up to .098" is Music Wire (MW); .105" and over is Oil Tempered Wire (OT). Stainless available up to .135" wire size. Above rates and loads are multiplied by .833 when using stainless. For prices from 1 to 100 see Price Index. Please inquire if you need a size not listed above.

STOCK COMPRESSION SPRINGS

Music Wire/Oil Tempered & Stainless (See Below)

Ends Squared and Ground Ends to be Square Within 3 Degrees of Axis

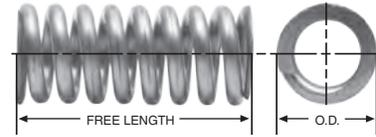

COMPRESSION SPRINGS

DIAMOND WIRE SPRING STOCK NO.	OUTSIDE DIAMETER	TO WORK IN HOLE DIA.	TO WORK OVER ROD DIA.	WIRE DIA.	APPROX. LOAD AT SOLID HT.	FREE LENGTH	SOLID HT.	TOTAL DEFLECTION	SPRING RATE	PRICE GROUP	
	IN.	IN.	IN.	IN.	LB.	IN.	IN.	IN.	LB./IN.	OT/MW	SS
DWC-148LM-17	1.187	1.218	0.843	0.148	125.000	4.500	2.059	2.441	51.6	S	
DWC-148LM-18						5.000	2.269	2.731	46.1	T	
DWC-156LM-8	1.187	1.218	0.812	0.156	141.000	1.000	0.630	0.370	380.8	M	
DWC-156LM-10						1.500	0.861	0.639	220.7	M	
DWC-156LM-12						2.000	1.092	0.908	155.4	N	
DWC-156LM-13						2.500	1.326	1.174	119.7	P	
DWC-156LM-14						3.000	1.555	1.445	97.5	R	
DWC-156LM-15						3.500	1.789	1.711	82.2	R	
DWC-156LM-16						4.000	2.018	1.982	71.1	S	
DWC-156LM-17						4.500	2.250	2.250	62.5	T	
DWC-156LM-18	5.000	2.480	2.520	55.9	T						
DWC-085M-7	1.225	1.250	1.011	0.085	21.025	0.875	0.303	0.572	36.6	K	O
DWC-085M-8						1.000	0.326	0.674	31.1	K	O
DWC-085M-9						1.500	0.418	1.082	19.4	K	O
DWC-085M-12						2.000	0.509	1.491	14.1	L	P
DWC-085M-13						2.500	0.599	1.901	11.1	L	P
DWC-085M-14						3.000	0.693	2.307	9.1	M	R
DWC-085M-15						3.500	0.779	2.721	7.8	N	T
DWC-085M-16						4.000	0.878	3.122	6.7	P	T
DWC-085M-17						4.500	0.960	3.540	6.0	P	T
DWC-085M-18						5.000	1.064	3.936	5.3	Q	U
DWC-096M-7	1.225	1.250	0.992	0.095	31.238	0.875	0.377	0.498	59.6	K	O
DWC-096M-8						1.000	0.402	0.598	50.4	K	O
DWC-096M-9						1.250	0.452	0.798	38.5	K	O
DWC-096M-10						1.500	0.502	0.998	31.1	L	P
DWC-096M-11						1.750	0.552	1.198	26.1	L	P
DWC-096M-12						2.000	0.602	1.398	22.5	M	R
DWC-096M-13						2.500	0.702	1.798	17.6	M	R
DWC-096M-14						3.000	0.802	2.198	14.5	N	T
DWC-096M-15						3.500	0.902	2.598	12.3	P	T
DWC-096M-16						4.000	1.002	2.998	10.7	P	T
DWC-096M-17						4.500	1.084	3.416	9.5	Q	U
DWC-096M-18	5.000	1.188	3.812	8.5	K	O					
DWC-105M-7	1.225	1.250	1.000	0.105	39.403	0.875	0.421	0.454	82.5	L	N
DWC-105M-8						1.000	0.450	0.550	69.5	L	N
DWC-105M-9						1.250	0.510	0.740	52.8	L	N
DWC-105M-10						1.500	0.569	0.931	42.5	M	O
DWC-105M-12						2.000	0.688	1.312	30.7	M	P
DWC-105M-13						2.500	0.807	1.693	24.0	O	Q
DWC-105M-14						3.000	0.926	2.074	19.7	O	T
DWC-105M-15						3.500	1.045	2.455	16.7	P	U
DWC-105M-16						4.000	1.164	2.836	14.5	P	U
DWC-105M-17						4.500	1.287	3.213	12.8	R	U
DWC-105M-18						5.000	1.408	3.592	11.5	R	U
DWC-112M-7	1.225	1.250	0.968	0.112	47.000	0.875	0.455	0.420	105.1	L	N
DWC-112M-8						1.000	0.488	0.512	88.2	L	N

Note: Wire Dia. up to .098" is Music Wire (MW); .105" and over is Oil Tempered Wire (OT). Stainless available up to .135" wire size. Above rates and loads are multiplied by .833 when using stainless. For prices from 1 to 100 see Price Index. Please inquire if you need a size not listed above.

STOCK COMPRESSION SPRINGS

Music Wire/Oil Tempered & Stainless (See Below)

Ends Squared and Ground Ends to be Square Within 3 Degrees of Axis

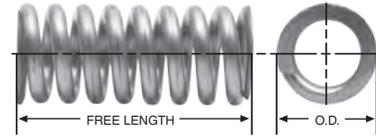

DIAMOND WIRE SPRING STOCK NO.	OUTSIDE DIAMETER	TO WORK IN HOLE DIA.	TO WORK OVER ROD DIA.	WIRE DIA.	APPROX. LOAD AT SOLID HT.	FREE LENGTH	SOLID HT.	TOTAL DEFLECTION	SPRING RATE	PRICE GROUP	
	IN.	IN.	IN.	IN.	LB.	IN.	IN.	IN.	LB./IN.	OT/MW	SS
DWC-112M-9	1.225	1.250	0.968	0.112	47.000	1.250	0.556	0.694	66.7	L	N
DWC-112M-10						1.500	0.623	0.877	53.6	M	O
DWC-112M-12						2.000	0.757	1.243	38.5	M	P
DWC-112M-13						2.500	0.891	1.609	30.1	O	Q
DWC-112M-14						3.000	1.026	1.974	24.6	O	T
DWC-112M-15						3.500	1.160	2.340	20.9	P	U
DWC-112M-16	4.000	1.294	2.706	18.1	R	U					
DWC-125M-7	1.225	1.250	0.937	0.125	63.489	0.875	0.517	0.358	161.3	M	P
DWC-125M-8						1.000	0.558	0.442	134.4	M	P
DWC-125M-9						1.250	0.639	0.611	100.8	M	P
DWC-125M-10						1.500	0.721	0.779	80.6	N	Q
DWC-125M-11						1.750	0.803	0.947	67.2	N	Q
DWC-125M-12						2.000	0.885	1.115	57.6	N	Q
DWC-125M-13						2.500	1.048	1.452	44.8	N	Q
DWC-125M-14						3.000	1.212	1.788	36.7	Q	T
DWC-125M-15						3.500	1.375	2.125	31.0	Q	U
DWC-125M-16						4.000	1.539	2.461	26.9	R	U
DWC-125M-17	4.500	1.648	2.852	24.9	R	U					
DWC-125M-18	5.000	1.812	3.188	22.3	R	U					
DWC-135M-7	1.225	1.250	0.906	0.135	75.000	0.875	0.565	0.310	219.2	P	S
DWC-135M-8						1.000	0.609	0.391	183.1	P	S
DWC-135M-9						1.250	0.702	0.548	136.4	P	T
DWC-135M-10						1.500	0.795	0.705	108.7	P	U
DWC-135M-12						2.000	0.982	1.018	77.3	P	U
DWC-135M-13						2.500	1.168	1.332	60.0	P	U
DWC-135M-14						3.000	1.354	1.646	49.0	Q	U
DWC-135M-15						3.500	1.540	1.960	41.4	Q	U
DWC-135M-16	4.000	1.723	2.277	34.3	T	U					
DWC-148M-7	1.225	1.250	0.906	0.148	93.000	0.875	0.621	0.254	325.0	P	
DWC-148M-8						1.000	0.673	0.327	269.6	P	
DWC-148M-9						1.250	0.781	0.469	198.9	P	
DWC-148M-10						1.500	0.888	0.612	157.6	P	
DWC-148M-12						2.000	1.104	0.896	111.4	P	
DWC-148M-13						2.500	1.319	1.181	86.1	P	
DWC-148M-14						3.000	1.534	1.466	70.2	Q	
DWC-148M-15						3.500	1.749	1.751	59.2	Q	
DWC-148M-16	4.000	1.965	2.035	51.2	S						
DWC-162M-12	1.225	1.250	0.843	0.162	130.000	2.000	1.175	0.825	157.0	P	
DWC-162M-13						2.500	1.417	1.083	122.0	P	
DWC-162M-14						3.000	1.701	1.299	97.0	Q	
DWC-162M-15						3.500	1.944	1.556	82.0	Q	
DWC-162M-16						4.000	2.187	1.813	72.0	S	
DWC-162M-17						4.500	2.430	2.070	63.0	S	
DWC-162M-18	5.000	2.673	2.327	57.0	T						
DWC-187M-12	1.225	1.250	0.812	0.187	175.000	2.000	1.402	0.598	286.0	P	
DWC-187M-13						2.500	1.683	0.817	224.0	P	
DWC-187M-14						3.000	2.010	0.990	180.0	Q	

COMPRESSION SPRINGS

Note: Wire Dia. up to .098" is Music Wire (MW); .105" and over is Oil Tempered Wire (OT). Stainless available up to .135" wire size. Above rates and loads are multiplied by .833 when using stainless. For prices from 1 to 100 see Price Index. Please inquire if you need a size not listed above.

STOCK COMPRESSION SPRINGS

Music Wire/Oil Tempered & Stainless (See Below)

Ends Squared and Ground Ends to be Square Within 3 Degrees of Axis

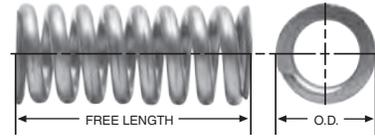

COMPRESSION SPRINGS

DIAMOND WIRE SPRING STOCK NO.	OUTSIDE DIAMETER	TO WORK IN HOLE DIA.	TO WORK OVER ROD DIA.	WIRE DIA.	APPROX. LOAD AT SOLID HT.	FREE LENGTH	SOLID HT.	TOTAL DEFLECTION	SPRING RATE	PRICE GROUP	
	IN.	IN.	IN.	IN.	LB.	IN.	IN.	IN.	LB./IN.	OT/MW	SS
DWC-187M-15	1.225	1.250	0.812	0.187	175.000	3.500	2.337	1.163	150.0	Q	
DWC-187M-16						4.000	2.665	1.335	128.0	S	
DWC-187M-17						4.500	2.992	1.508	112.0	T	
DWC-187M-18						5.000	3.272	1.728	101.0	U	
DWC-187M-19						6.000	3.297	2.703	83.0	U	
DWC-225M-12	1.225	1.250	0.750	0.225	369.000	2.000	1.519	0.481	775.0	W	
DWC-225M-13						2.500	1.856	0.644	589.0	W	
DWC-225M-14						3.000	2.222	0.778	468.0	W	
DWC-225M-15						3.500	2.559	0.941	393.0	W	
DWC-225M-16						4.000	2.925	1.075	335.0	X	
DWC-225M-17						4.500	3.262	1.238	295.0	X	
DWC-225M-18						5.000	3.600	1.400	263.0	X	
DWC-225M-19						6.000	4.275	1.725	218.0	Y	
DWC-250M-12	1.225	1.250	0.687	0.250	505.000	2.000	1.625	0.375	1346.0	W	
DWC-250M-13						2.500	2.000	0.500	1010.0	W	
DWC-250M-14						3.000	2.375	0.625	808.0	X	
DWC-250M-15						3.500	2.750	0.750	673.0	X	
DWC-250M-16						4.000	3.125	0.875	577.0	X	
DWC-250M-17						4.500	3.500	1.000	505.0	Y	
DWC-250M-18						5.000	3.875	1.125	449.0	Y	
DWC-250M-19						6.000	4.625	1.375	367.0	Z	
DWC-112MN-10	1.343	1.375	1.031	0.112	44.000	1.500	0.523	0.977	45.4	M	O
DWC-112MN-12						2.000	0.641	1.359	32.6	M	P
DWC-112MN-13						2.500	0.757	1.743	25.5	O	Q
DWC-112MN-14						3.000	0.875	2.125	20.9	O	T
DWC-112MN-15						3.500	0.992	2.508	17.7	P	U
DWC-112MN-16						4.000	1.109	2.891	15.4	R	U
DWC-112MN-17						4.500	1.226	3.274	13.5	R	U
DWC-112MN-18						5.000	1.344	3.656	12.1	R	U
DWC-125MN-10	1.343	1.375	1.000	0.125	63.000	1.500	0.593	0.907	70.6	N	Q
DWC-125MN-12						2.000	0.718	1.282	51.8	N	Q
DWC-125MN-13						2.500	0.875	1.625	38.8	N	Q
DWC-125MN-14						3.000	1.000	2.000	32.4	Q	T
DWC-125MN-15						3.500	1.156	2.344	26.8	Q	U
DWC-125MN-16						4.000	1.281	2.719	23.5	R	U
DWC-125MN-17						4.500	1.421	3.079	20.7	R	U
DWC-125MN-18						5.000	1.559	3.441	18.5	R	U
DWC-135MN-10	1.343	1.375	1.000	0.135	79.000	1.500	0.659	0.841	94.0	P	U
DWC-135MN-12						2.000	0.817	1.183	66.9	P	U
DWC-135MN-13						2.500	0.975	1.525	51.9	P	U
DWC-135MN-14						3.000	1.134	1.866	42.4	Q	U
DWC-135MN-15						3.500	1.291	2.209	35.8	Q	U
DWC-135MN-16						4.000	1.450	2.550	31.0	T	U
DWC-135MN-17						4.500	1.608	2.892	27.3	T	U
DWC-135MN-18						5.000	1.765	3.235	24.5	T	U
DWC-148MN-10	1.343	1.375	0.968	0.148	102.000	1.500	0.740	0.760	134.7	P	
DWC-148MN-12						2.000	0.925	1.075	95.1	P	

Note: Wire Dia. up to .098" is Music Wire (MW); .105" and over is Oil Tempered Wire (OT). Stainless available up to .135" wire size. Above rates and loads are multiplied by .833 when using stainless. For prices from 1 to 100 see Price Index. Please inquire if you need a size not listed above.

STOCK COMPRESSION SPRINGS

Music Wire/Oil Tempered & Stainless (See Below)

Ends Squared and Ground Ends to be Square Within 3 Degrees of Axis

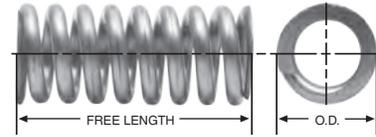

DIAMOND WIRE SPRING STOCK NO.	OUTSIDE DIAMETER	TO WORK IN HOLE DIA.	TO WORK OVER ROD DIA.	WIRE DIA.	APPROX. LOAD AT SOLID HT.	FREE LENGTH	SOLID HT.	TOTAL DEFLECTION	SPRING RATE	PRICE GROUP	
	IN.	IN.	IN.	IN.	LB.	IN.	IN.	IN.	LB./IN.	OT/MW	SS
DWC-148MN-13	1.343	1.375	0.968	0.148	102.000	2.500	1.110	1.390	73.5	P	
DWC-148MN-14						3.000	1.295	1.705	59.9	Q	
DWC-148MN-15						3.500	1.480	2.020	50.5	Q	
DWC-148MN-16						4.000	1.665	2.335	43.7	T	
DWC-148MN-17						4.500	1.850	2.650	38.5	T	
DWC-148MN-18						5.000	2.035	2.965	34.4	T	
DWC-162MN-10	1.343	1.375	0.968	0.162	140.000	1.500	0.810	0.690	200.3	P	
DWC-162MN-12						2.000	1.012	0.988	141.4	P	
DWC-162MN-13						2.500	1.215	1.285	109.3	P	
DWC-162MN-14						3.000	1.417	1.583	89.0	Q	
DWC-162MN-15						3.500	1.620	1.880	75.1	Q	
DWC-162MN-16						4.000	1.822	2.178	65.0	T	
DWC-162MN-17						4.500	2.027	2.473	57.2	T	
DWC-162MN-18						5.000	2.229	2.771	51.1	T	
DWC-187MN-10	1.343	1.375	0.906	0.187	180.000	1.500	0.984	0.516	349.0	P	
DWC-187MN-12						2.000	1.255	0.745	241.6	P	
DWC-187MN-13						2.500	1.526	0.974	184.7	P	
DWC-187MN-14						3.000	1.796	1.204	149.7	Q	
DWC-187MN-15						3.500	2.067	1.433	125.7	Q	
DWC-187MN-16						4.000	2.338	1.662	108.4	T	
DWC-187MN-17						4.500	2.609	1.891	95.2	T	
DWC-187MN-18						5.000	2.880	2.120	85.0	U	
DWC-218MN-10	1.343	1.375	0.828	0.218	251.000	1.500	1.142	0.358	703.8	W	
DWC-218MN-12						2.000	1.474	0.526	479.0	W	
DWC-218MN-13						2.500	1.807	0.693	362.5	W	
DWC-218MN-14						3.000	2.139	0.861	292.0	W	
DWC-218MN-15						3.500	2.470	1.030	244.4	X	
DWC-218MN-16						4.000	2.801	1.199	210.2	X	
DWC-218MN-17						4.500	3.135	1.365	184.2	X	
DWC-218MN-18						5.000	3.466	1.534	164.0	Y	
DWC-112N-10	1.460	1.500	1.187	0.112	41.000	1.500	0.531	0.969	41.3	M	P
DWC-112N-12						2.000	0.629	1.371	29.6	M	P
DWC-112N-13						2.500	0.727	1.773	23.1	O	R
DWC-112N-14						3.000	0.825	2.175	19.0	P	U
DWC-112N-15						3.500	0.924	2.576	16.1	P	U
DWC-112N-16						4.000	1.022	2.978	13.9	R	U
DWC-125N-10	1.460	1.500	1.187	0.125	55.000	1.500	0.616	0.884	60.7	N	S
DWC-125N-12						2.000	0.738	1.262	43.4	N	S
DWC-125N-13						2.500	0.859	1.641	33.7	N	S
DWC-125N-14						3.000	0.981	2.019	27.6	Q	U
DWC-125N-15						3.500	1.102	2.398	23.3	Q	U
DWC-125N-16						4.000	1.224	2.776	20.2	R	U
DWC-135N-10	1.460	1.500	1.125	0.135	65.000	1.500	0.682	0.818	80.3	P	U
DWC-135N-12						2.000	0.823	1.177	57.1	P	U
DWC-135N-13						2.500	0.963	1.537	44.3	P	U
DWC-135N-14						3.000	1.103	1.897	36.2	Q	U

COMPRESSION SPRINGS

Note: Wire Dia. up to .098" is Music Wire (MW); .105" and over is Oil Tempered Wire (OT). Stainless available up to .135" wire size. Above rates and loads are multiplied by .833 when using stainless. For prices from 1 to 100 see Price Index. Please inquire if you need a size not listed above.

STOCK COMPRESSION SPRINGS

Music Wire/Oil Tempered & Stainless (See Below)

Ends Squared and Ground Ends to be Square Within 3 Degrees of Axis

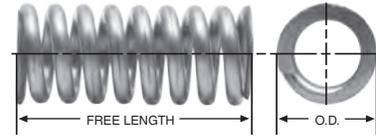

COMPRESSION SPRINGS

DIAMOND WIRE SPRING STOCK NO.	OUTSIDE DIAMETER	TO WORK IN HOLE DIA.	TO WORK OVER ROD DIA.	WIRE DIA.	APPROX. LOAD AT SOLID HT.	FREE LENGTH	SOLID HT.	TOTAL DEFLECTION	SPRING RATE	PRICE GROUP	
	IN.	IN.	IN.	IN.	LB.	IN.	IN.	IN.	LB./IN.	OT/MW	SS
DWC-135N-15	1.460	1.500	1.125	0.135	65.000	3.500	1.243	2.257	30.6	Q	U
DWC-135N-16						4.000	1.393	2.607	26.5	T	U
DWC-148N-10	1.460	1.500	1.125	0.148	86.000	1.500	0.768	0.732	113.7	P	
DWC-148N-12						2.000	0.933	1.067	80.3	P	
DWC-148N-13						2.500	1.098	1.402	62.1	P	
DWC-148N-14						3.000	1.263	1.737	50.6	Q	
DWC-148N-15						3.500	1.428	2.072	42.7	R	
DWC-148N-16						4.000	1.593	2.407	37.0	T	
DWC-162N-10	1.460	1.500	1.062	0.162	109.000	1.500	0.857	0.643	162.4	P	
DWC-162N-12						2.000	1.049	0.951	114.0	P	
DWC-162N-13						2.500	1.241	1.259	87.8	P	
DWC-162N-14						3.000	1.433	1.567	71.4	Q	
DWC-162N-15						3.500	1.625	1.875	60.1	R	
DWC-162N-16						4.000	1.817	2.183	52.0	T	
DWC-162N-17						4.500	2.009	2.491	45.7	T	
DWC-162N-18						5.000	2.201	2.799	40.8	T	
DWC-187N-10	1.460	1.500	1.000	0.187	195.000	1.500	0.888	0.612	310.0	P	
DWC-187N-12						2.000	1.157	0.843	230.0	P	
DWC-187N-13						2.500	1.337	1.163	168.0	Q	
DWC-187N-14						3.000	1.546	1.454	138.0	Q	
DWC-187N-15						3.500	1.769	1.731	116.0	R	
DWC-187N-16						4.000	2.008	1.992	99.0	T	
DWC-187N-17						4.500	2.255	2.245	86.0	T	
DWC-187N-18						5.000	2.474	2.526	77.0	U	
DWC-218N-12	1.460	1.500	1.000	0.218	253.000	2.000	1.362	0.638	398.0	W	
DWC-218N-13						2.500	1.662	0.838	301.0	W	
DWC-218N-14						3.000	1.962	1.038	242.0	W	
DWC-218N-15						3.500	2.234	1.266	205.0	W	
DWC-218N-16						4.000	2.561	1.439	174.0	X	
DWC-218N-17						4.500	2.834	1.666	154.0	X	
DWC-218N-18						5.000	3.161	1.839	136.0	X	
DWC-218N-19	6.000	3.706	2.294	113.0	Y						
DWC-250N-12	1.460	1.500	0.875	0.250	394.000	2.000	1.500	0.500	792.0	W	
DWC-250N-13						2.500	1.843	0.657	590.0	W	
DWC-250N-14						3.000	2.156	0.844	478.0	X	
DWC-250N-15						3.500	2.500	1.000	396.0	X	
DWC-250N-16						4.000	2.844	1.156	338.0	X	
DWC-250N-17						4.500	3.188	1.312	295.0	Y	
DWC-250N-18						5.000	3.500	1.500	264.0	Z	
DWC-250N-19	6.000	4.156	1.844	217.0	AA						
DWC-281N-12	1.460	1.500	0.812	0.281	565.000	2.000	1.616	0.384	1458.0	X	
DWC-281N-13						2.500	1.967	0.533	1094.0	Y	
DWC-281N-14						3.000	2.353	0.647	858.0	Z	
DWC-281N-15						3.500	2.705	0.795	717.0	Z	
DWC-281N-16						4.000	3.091	0.909	608.0	AA	
DWC-281N-17						4.500	3.442	1.058	533.0	AB	

Note: Wire Dia. up to .098" is Music Wire (MW); .105" and over is Oil Tempered Wire (OT). Stainless available up to .135" wire size. Above rates and loads are multiplied by .833 when using stainless. For prices from 1 to 100 see Price Index. Please inquire if you need a size not listed above.

STOCK COMPRESSION SPRINGS

Music Wire/Oil Tempered & Stainless (See Below)

Ends Squared and Ground Ends to be Square Within 3 Degrees of Axis

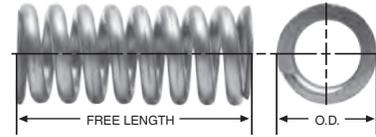

DIAMOND WIRE SPRING STOCK NO.	OUTSIDE DIAMETER	TO WORK IN HOLE DIA.	TO WORK OVER ROD DIA.	WIRE DIA.	APPROX. LOAD AT SOLID HT.	FREE LENGTH	SOLID HT.	TOTAL DEFLECTION	SPRING RATE	PRICE GROUP	
	IN.	IN.	IN.	IN.	LB.	IN.	IN.	IN.	LB./IN.	OT/MW	SS
DWC-281N-18 DWC-281N-19	1.460	1.500	0.812	0.281	565.000	5.000 6.000	3.794 4.531	1.206 1.469	476.0 387.0	AC AD	
DWC-135NO-10 DWC-135NO-12 DWC-135NO-13 DWC-135NO-14 DWC-135NO-15 DWC-135NO-16 DWC-135NO-17 DWC-135NO-18 DWC-135NO-19	1.580	1.625	1.250	0.135	59.000	1.500 2.000 2.500 3.000 3.500 4.000 4.500 5.000 6.000	0.595 0.728 0.860 0.992 1.125 1.257 1.389 1.521 1.786	0.905 1.272 1.640 2.008 2.375 2.743 3.111 3.479 4.214	65.7 46.7 36.2 29.6 25.0 21.6 19.1 17.1 14.1	P P P Q Q T T T T	U U U U U U U U U
DWC-148NO-10 DWC-148NO-12 DWC-148NO-13 DWC-148NO-14 DWC-148NO-15 DWC-148NO-16 DWC-148NO-17 DWC-148NO-18 DWC-148NO-19	1.580	1.625	1.250	0.148	84.000	1.500 2.000 2.500 3.000 3.500 4.000 4.500 5.000 6.000	0.647 0.795 0.943 1.091 1.239 1.387 1.535 1.683 1.982	0.853 1.205 1.557 1.909 2.261 2.613 2.965 3.317 4.018	99.0 69.6 53.7 43.7 36.8 31.8 28.0 25.0 20.6	P P P Q R T T T U	
DWC-162NO-10 DWC-162NO-12 DWC-162NO-13 DWC-162NO-14 DWC-162NO-15 DWC-162NO-16 DWC-162NO-17 DWC-162NO-18 DWC-162NO-19	1.580	1.625	1.218	0.162	109.000	1.500 2.000 2.500 3.000 3.500 4.000 4.500 5.000 6.000	0.729 0.891 1.053 1.025 1.417 1.579 1.741 1.903 2.242	0.771 1.109 1.447 1.975 2.083 2.421 2.759 3.097 3.758	138.9 99.2 77.2 60.4 51.4 44.8 39.7 35.6 29.3	P P P Q R T T T U	
DWC-187NO-10 DWC-187NO-12 DWC-187NO-13 DWC-187NO-14 DWC-187NO-15 DWC-187NO-16 DWC-187NO-17 DWC-187NO-18 DWC-187NO-19	1.580	1.625	1.093	0.187	172.000	1.500 2.000 2.500 3.000 3.500 4.000 4.500 5.000 6.000	0.841 1.052 1.262 1.449 1.683 1.870 2.104 2.291 2.706	0.659 0.948 1.238 1.551 1.817 2.130 2.396 2.709 3.294	260.1 179.4 136.9 113.1 92.9 81.3 70.3 63.4 52.1	P P Q Q R T T U U	
DWC-218NO-10 DWC-218NO-12 DWC-218NO-13 DWC-218NO-14 DWC-218NO-15 DWC-218NO-16 DWC-218NO-17 DWC-218NO-18 DWC-218NO-19	1.580	1.625	1.062	0.218	223.000	1.500 2.000 2.500 3.000 3.500 4.000 4.500 5.000 6.000	1.029 1.308 1.587 1.862 2.142 2.422 2.701 2.980 3.536	0.471 0.692 0.913 1.138 1.358 1.578 1.799 2.020 2.464	472.4 321.3 243.4 196.2 164.1 141.0 123.7 110.1 90.4	W W W W X X X Y Z	

COMPRESSION SPRINGS

Note: Wire Dia. up to .098" is Music Wire (MW); .105" and over is Oil Tempered Wire (OT). Stainless available up to .135" wire size. Above rates and loads are multiplied by .833 when using stainless. For prices from 1 to 100 see Price Index. Please inquire if you need a size not listed above.

STOCK COMPRESSION SPRINGS

Music Wire/Oil Tempered & Stainless (See Below)

Ends Squared and Ground Ends to be Square Within 3 Degrees of Axis

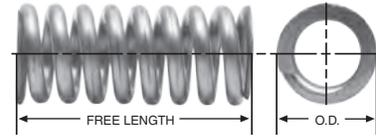

COMPRESSION SPRINGS

DIAMOND WIRE SPRING STOCK NO.	OUTSIDE DIAMETER	TO WORK IN HOLE DIA.	TO WORK OVER ROD DIA.	WIRE DIA.	APPROX. LOAD AT SOLID HT.	FREE LENGTH	SOLID HT.	TOTAL DEFLECTION	SPRING RATE	PRICE GROUP	
	IN.	IN.	IN.	IN.	LB.	IN.	IN.	IN.	LB./IN.	OT/MW	SS
DWC-250NO-10	1.580	1.625	1.000	0.250	310.000	1.500	1.158	0.342	907.5	W	
DWC-250NO-12						2.000	1.488	0.512	604.2	W	
DWC-250NO-13						2.500	1.815	0.685	453.8	X	
DWC-250NO-14						3.000	2.145	0.855	362.7	X	
DWC-250NO-15						3.500	2.473	1.027	302.5	Y	
DWC-250NO-16						4.000	2.803	1.197	259.2	Y	
DWC-250NO-17						4.500	3.130	1.370	226.9	Z	
DWC-250NO-18						5.000	3.460	1.540	201.6	Z	
DWC-250NO-19						6.000	4.118	1.882	164.9	AB	
DWC-1350-10	1.687	1.750	1.375	0.135	60.000	1.500	0.605	0.895	64.4	P	U
DWC-1350-12						2.000	0.714	1.286	45.8	P	U
DWC-1350-13						2.500	0.823	1.677	35.5	P	U
DWC-1350-14						3.000	0.932	2.068	29.0	Q	U
DWC-1350-15						3.500	1.041	2.459	24.5	Q	U
DWC-1350-16						4.000	1.150	2.850	21.2	T	U
DWC-1350-17						4.500	1.259	3.241	18.7	T	U
DWC-1350-18						5.000	1.368	3.632	16.7	T	U
DWC-1480-10	1.687	1.750	1.375	0.148	75.000	1.500	0.682	0.818	89.7	P	
DWC-1480-12						2.000	0.812	1.188	63.4	P	
DWC-1480-13						2.500	0.942	1.558	49.0	P	
DWC-1480-14						3.000	1.071	1.929	39.9	Q	
DWC-1480-15						3.500	1.201	2.299	33.7	R	
DWC-1480-16						4.000	1.331	2.669	29.1	T	
DWC-1480-17						4.500	1.461	3.039	25.7	T	
DWC-1480-18						5.000	1.590	3.410	22.9	T	
DWC-1620-10	1.687	1.750	1.312	0.162	96.000	1.500	0.765	0.735	125.8	P	
DWC-1620-12						2.000	0.918	1.082	88.2	P	
DWC-1620-13						2.500	1.070	1.430	68.0	Q	
DWC-1620-14						3.000	1.223	1.777	55.3	Q	
DWC-1620-15						3.500	1.376	2.124	46.6	R	
DWC-1620-16						4.000	1.529	2.471	40.2	T	
DWC-1620-17						4.500	1.682	2.818	35.4	T	
DWC-1620-18						5.000	1.835	3.165	31.6	T	
DWC-1770-10	1.687	1.750	1.312	0.177	121.000	1.500	0.851	0.649	177.7	P	
DWC-1770-12						2.000	1.029	0.971	123.7	P	
DWC-1770-13						2.500	1.207	1.293	94.9	Q	
DWC-1770-14						3.000	1.385	1.615	76.9	Q	
DWC-1770-15						3.500	1.563	1.937	64.7	R	
DWC-1770-16						4.000	1.741	2.259	55.8	T	
DWC-1770-17						4.500	1.920	2.580	49.1	T	
DWC-1770-18						5.000	2.098	2.902	43.8	T	
DWC-1920-10	1.687	1.750	1.281	0.192	149.000	1.500	0.934	0.566	247.4	R	
DWC-1920-12						2.000	1.137	0.863	170.9	S	
DWC-1920-13						2.500	1.340	1.160	130.5	T	
DWC-1920-14						3.000	1.543	1.457	105.6	T	
DWC-1920-15						3.500	1.747	1.753	88.6	T	
DWC-1920-16						4.000	1.950	2.050	76.4	U	

Note: Wire Dia. up to .098" is Music Wire (MW); .105" and over is Oil Tempered Wire (OT). Stainless available up to .135" wire size. Above rates and loads are multiplied by .833 when using stainless. For prices from 1 to 100 see Price Index. Please inquire if you need a size not listed above.

STOCK COMPRESSION SPRINGS

Music Wire/Oil Tempered
(See Below)

Ends Squared and Ground Ends to
be Square Within 3 Degrees of Axis

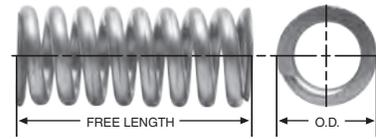

DIAMOND WIRE SPRING STOCK NO.	OUTSIDE DIAMETER	TO WORK IN HOLE DIA.	TO WORK OVER ROD DIA.	WIRE DIA.	APPROX. LOAD AT SOLID HT.	FREE LENGTH	SOLID HT.	TOTAL DEFLECTION	SPRING RATE	PRICE GROUP	
	IN.	IN.	IN.	IN.	LB.	IN.	IN.	IN.	LB./IN.	OT/MW	SS
DWC-1920-17 DWC-1920-18	1.687	1.750	1.281	0.192	149.000	4.500 5.000	2.153 2.356	2.347 2.644	67.1 59.8	U	
DWC-2180-13 DWC-2180-14 DWC-2180-15 DWC-2180-16 DWC-2180-17 DWC-2180-18	1.687	1.750	1.218	0.218	245.000	2.500 3.000 3.500 4.000 4.500 5.000	1.415 1.668 1.903 2.152 2.387 2.625	1.085 1.332 1.597 1.848 2.113 2.375	228.0 181.0 152.0 130.0 114.0 102.0	W W X X X Y	
DWC-2500-13 DWC-2500-14 DWC-2500-15 DWC-2500-16 DWC-2500-17 DWC-2500-18 DWC-2500-19	1.687	1.750	1.125	0.250	321.000	2.500 3.000 3.500 4.000 4.500 5.000 6.000	1.687 2.000 2.312 2.562 2.875 3.187 3.750	0.813 1.000 1.188 1.438 1.625 1.813 2.250	398.0 315.0 261.0 229.0 199.0 176.0 146.0	W X X Y Y Z AB	
DWC-2810-13 DWC-2810-14 DWC-2810-15 DWC-2810-16 DWC-2810-17 DWC-2810-18 DWC-2810-19	1.687	1.750	1.063	0.281	489.000	2.500 3.000 3.500 4.000 4.500 5.000 6.000	1.826 2.143 2.459 2.810 3.126 3.442 4.074	0.674 0.857 1.041 1.190 1.374 1.558 1.926	716.0 573.0 478.0 403.0 353.0 315.0 258.0	Z Z AA AB AC AD AE	
DWC-3120-13 DWC-3120-14 DWC-3120-15 DWC-3120-16 DWC-3120-17 DWC-3120-18 DWC-3120-19	1.687	1.750	1.000	0.312	684.000	2.500 3.000 3.500 4.000 4.500 5.000 6.000	1.950 2.301 2.652 3.000 3.354 3.705 4.407	0.550 0.699 0.848 1.000 1.146 1.295 1.593	1233.0 975.0 806.0 687.0 599.0 530.0 432.0	AB AC AD AD AE AE AF	
DWC-1480P-12 DWC-1480P-13 DWC-1480P-14 DWC-1480P-15 DWC-1480P-16 DWC-1480P-17 DWC-1480P-18 DWC-1480P-19	1.812	1.875	1.437	0.148	68.000	2.000 2.500 3.000 3.500 4.000 4.500 5.000 6.000	0.716 0.839 0.962 1.086 1.209 1.332 1.455 1.702	1.284 1.661 2.038 2.414 2.791 3.168 3.545 4.298	52.7 40.8 33.2 28.0 24.3 21.4 19.1 15.7	P Q Q R T T T U	
DWC-1620P-12 DWC-1620P-13 DWC-1620P-14 DWC-1620P-15 DWC-1620P-16 DWC-1620P-17 DWC-1620P-18 DWC-1620P-19	1.812	1.875	1.406	0.162	97.000	2.000 2.500 3.000 3.500 4.000 4.500 5.000 6.000	0.770 0.891 1.053 1.174 1.336 1.458 1.580 1.850	1.230 1.609 1.947 2.326 2.664 3.042 3.420 4.150	80.1 63.0 49.0 42.0 35.3 31.5 28.4 23.4	P Q Q R T T T U	
DWC-1870P-12 DWC-1870P-13	1.812	1.875	1.375	0.187	143.000	2.000 2.500	0.935 1.122	1.065 1.378	136.5 102.4	Q T	

Note: Wire Dia. up to .098" is Music Wire (MW); .105" and over is Oil Tempered Wire (OT). For prices from 1 to 100 see Price Index. Please inquire if you need a size not listed above.

STOCK COMPRESSION SPRINGS

Music Wire/Oil Tempered
(See Below)

Ends Squared and Ground Ends to
be Square Within 3 Degrees of Axis

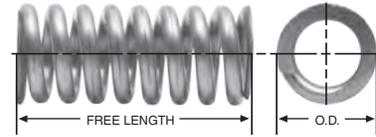

COMPRESSION SPRINGS

DIAMOND WIRE SPRING STOCK NO.	OUTSIDE DIAMETER	TO WORK IN HOLE DIA.	TO WORK OVER ROD DIA.	WIRE DIA.	APPROX. LOAD AT SOLID HT.	FREE LENGTH	SOLID HT.	TOTAL DEFLECTION	SPRING RATE	PRICE GROUP	
	IN.	IN.	IN.	IN.	LB.	IN.	IN.	IN.	LB./IN.	OT/MW	SS
DWC-1870P-14	1.812	1.875	1.375	0.187	143.000	3.000	1.285	1.715	84.0	T	
DWC-1870P-15						3.500	1.449	2.051	71.2	T	
DWC-1870P-16						4.000	1.636	2.364	60.7	T	
DWC-1870P-17						4.500	1.823	2.677	52.8	T	
DWC-1870P-18						5.000	1.963	3.037	48.2	U	
DWC-1870P-19						6.000	2.308	3.692	39.6	U	
DWC-2070P-12	1.812	1.875	1.343	0.207	203.000	2.000	1.035	0.965	212.8	X	
DWC-2070P-13						2.500	1.242	1.258	159.6	Y	
DWC-2070P-14						3.000	1.423	1.577	130.9	Y	
DWC-2070P-15						3.500	1.630	1.870	108.6	Y	
DWC-2070P-16						4.000	1.811	2.189	94.6	Z	
DWC-2070P-17						4.500	2.018	2.482	82.4	Z	
DWC-2070P-18	5.000	2.225	2.775	73.0	AA						
DWC-2070P-19	6.000	2.619	3.381	59.9	AB						
DWC-2180P-12	1.812	1.875	1.281	0.218	235.000	2.000	1.103	0.897	262.0	Y	
DWC-2180P-13						2.500	1.317	1.183	198.4	Y	
DWC-2180P-14						3.000	1.530	1.470	159.7	Y	
DWC-2180P-15						3.500	1.744	1.756	133.6	Z	
DWC-2180P-16						4.000	1.955	2.045	115.0	AA	
DWC-2180P-17						4.500	2.170	2.330	100.8	AB	
DWC-2180P-18	5.000	2.383	2.617	89.8	AB						
DWC-2180P-19	6.000	2.812	3.188	73.6	AC						
DWC-2500P-12	1.812	1.875	1.218	0.250	300.000	2.000	1.328	0.672	445.1	Y	
DWC-2500P-13						2.500	1.603	0.897	334.1	Z	
DWC-2500P-14						3.000	1.878	1.122	266.9	AA	
DWC-2500P-15						3.500	2.153	1.347	222.6	AB	
DWC-2500P-16						4.000	2.430	1.570	190.8	AC	
DWC-2500P-17						4.500	2.703	1.797	166.9	AC	
DWC-2500P-18	5.000	2.983	2.017	148.4	AD						
DWC-2500P-19	6.000	3.535	2.465	121.4	AD						
DWC-2810P-12	1.812	1.875	1.218	0.281	410.000	2.000	1.470	0.530	773.2	Z	
DWC-2810P-13						2.500	1.784	0.716	574.1	AA	
DWC-2810P-14						3.000	2.102	0.898	455.8	AB	
DWC-2810P-15						3.500	2.418	1.082	378.4	AC	
DWC-2810P-16						4.000	2.731	1.269	325.5	AD	
DWC-2810P-17						4.500	3.049	1.451	282.2	AD	
DWC-2810P-18	5.000	3.364	1.636	250.5	AE						
DWC-2810P-19	6.000	3.993	2.007	204.5	AE						
DWC-148P-12	1.937	2.000	1.593	0.148	67.000	2.000	0.716	1.284	51.6	P	
DWC-148P-13						2.500	0.817	1.683	39.9	Q	
DWC-148P-14						3.000	0.919	2.081	32.5	Q	
DWC-148P-15						3.500	1.020	2.480	27.4	R	
DWC-148P-16						4.000	1.122	2.878	23.7	T	
DWC-148P-17						4.500	1.223	3.277	20.9	T	
DWC-148P-18	5.000	1.324	3.676	18.7	T						
DWC-162P-12	1.937	2.000	1.562	0.162	86.000	2.000	0.810	1.190	70.8	Q	
DWC-162P-13						2.500	0.931	1.569	54.5	Q	

Note: Wire Dia. up to .098" is Music Wire (MW); .105" and over is Oil Tempered Wire (OT). For prices from 1 to 100 see Price Index. Please inquire if you need a size not listed above.

STOCK COMPRESSION SPRINGS

Music Wire/Oil Tempered
(See Below)

Ends Squared and Ground Ends to
be Square Within 3 Degrees of Axis

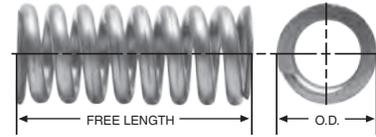

DIAMOND WIRE SPRING STOCK NO.	OUTSIDE DIAMETER	TO WORK IN HOLE DIA.	TO WORK OVER ROD DIA.	WIRE DIA.	APPROX. LOAD AT SOLID HT.	FREE LENGTH	SOLID HT.	TOTAL DEFLECTION	SPRING RATE	PRICE GROUP	
	IN.	IN.	IN.	IN.	LB.	IN.	IN.	IN.	LB./IN.	OT/MW	SS
DWC-162P-14	1.937	2.000	1.562	0.162	86.000	3.000	1.052	1.948	44.3	R	
DWC-162P-15						3.500	1.173	2.327	37.4	R	
DWC-162P-16						4.000	1.293	2.707	32.3	T	
DWC-162P-17						4.500	1.414	3.086	28.4	T	
DWC-162P-18						5.000	1.535	3.465	25.4	U	
DWC-177P-13	1.937	2.000	1.531	0.177	110.000	2.500	1.054	1.446	74.9	Q	
DWC-177P-14						3.000	1.196	1.804	60.8	T	
DWC-177P-15						3.500	1.339	2.161	51.1	T	
DWC-177P-16						4.000	1.481	2.519	44.1	T	
DWC-177P-17						4.500	1.624	2.876	38.8	U	
DWC-177P-18						5.000	1.766	3.234	34.6	U	
DWC-177P-19	6.000	2.051	3.949	28.5	U						
DWC-192P-13	1.937	2.000	1.500	0.192	137.000	2.500	1.176	1.324	101.4	T	
DWC-192P-14						3.000	1.341	1.659	82.0	T	
DWC-192P-15						3.500	1.505	1.995	68.8	U	
DWC-192P-16						4.000	1.670	2.330	59.3	U	
DWC-192P-17						4.500	1.834	2.666	52.1	U	
DWC-192P-18						5.000	1.999	3.001	46.5	U	
DWC-192P-19	6.000	2.328	3.672	38.2	U						
DWC-207P-13	1.937	2.000	1.500	0.207	167.000	2.500	1.297	1.203	135.4	Y	
DWC-207P-14						3.000	1.483	1.517	109.2	Y	
DWC-207P-15						3.500	1.670	1.830	91.5	Y	
DWC-207P-16						4.000	1.857	2.143	78.8	Y	
DWC-207P-17						4.500	2.044	2.456	69.1	Z	
DWC-207P-18						5.000	2.230	2.770	61.6	AA	
DWC-207P-19	6.000	2.604	3.396	50.6	AB						
DWC-218P-13	1.937	2.000	1.437	0.218	228.000	2.500	1.253	1.247	170.4	Y	
DWC-218P-14						3.000	1.472	1.528	134.5	Y	
DWC-218P-15						3.500	1.635	1.865	116.2	Z	
DWC-218P-16						4.000	1.798	2.202	102.3	Z	
DWC-218P-17						4.500	1.962	2.538	91.3	AA	
DWC-218P-18						5.000	2.125	2.875	82.5	AB	
DWC-218P-19	6.000	2.453	3.547	69.1	AC						
DWC-250P-13	1.937	2.000	1.375	0.250	304.000	2.500	1.562	0.938	275.0	Z	
DWC-250P-14						3.000	1.750	1.250	234.0	AA	
DWC-250P-15						3.500	1.937	1.563	203.4	AB	
DWC-250P-16						4.000	2.187	1.813	173.3	AB	
DWC-250P-17						4.500	2.375	2.125	156.0	AC	
DWC-250P-18						5.000	2.562	2.438	141.8	AC	
DWC-250P-19	6.000	3.000	3.000	116.9	AD						
DWC-281P-14	1.937	2.000	1.312	0.281	407.000	3.000	1.967	1.033	395.0	AC	
DWC-281P-16						4.000	2.529	1.471	282.0	AD	
DWC-281P-18						5.000	3.126	1.874	216.0	AD	
DWC-281P-19						6.000	3.723	2.277	175.0	AE	
DWC-281P-20						7.000	4.285	2.715	149.0	AF	
DWC-281P-21						8.000	4.847	3.153	129.0	AF	
DWC-281P-22						9.000	5.409	3.591	114.0	AG	

Note: Wire Dia. up to .098" is Music Wire (MW); .105" and over is Oil Tempered Wire (OT). For prices from 1 to 100 see Price Index. Please inquire if you need a size not listed above.

STOCK COMPRESSION SPRINGS

Music Wire/Oil Tempered
(See Below)

Ends Squared and Ground Ends to
be Square Within 3 Degrees of Axis

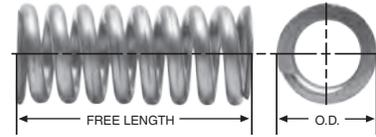

COMPRESSION SPRINGS

DIAMOND WIRE SPRING STOCK NO.	OUTSIDE DIAMETER	TO WORK IN HOLE DIA.	TO WORK OVER ROD DIA.	WIRE DIA.	APPROX. LOAD AT SOLID HT.	FREE LENGTH	SOLID HT.	TOTAL DEFLECTION	SPRING RATE	PRICE GROUP	
	IN.	IN.	IN.	IN.	LB.	IN.	IN.	IN.	LB./IN.	OT/MW	SS
DWC-312P-14	1.937	2.000	1.250	0.312	597.000	3.000	2.106	0.894	668.0	AE	
DWC-312P-16						4.000	2.730	1.270	470.0	AF	
DWC-312P-18						5.000	3.354	1.646	363.0	AF	
DWC-312P-19						6.000	3.978	2.022	295.0	AG	
DWC-312P-20						7.000	4.602	2.398	249.0	AG	
DWC-312P-21						8.000	5.226	2.774	215.0	AH	
DWC-312P-22	9.000	5.850	3.150	190.0	AH						
DWC-343P-14	1.937	2.000	1.187	0.343	772.000	3.000	2.272	0.728	1062.0	AF	
DWC-343P-16						4.000	2.958	1.042	742.0	AF	
DWC-343P-18						5.000	3.644	1.356	570.0	AG	
DWC-343P-19						6.000	4.330	1.670	462.0	AG	
DWC-343P-20						7.000	5.016	1.984	389.0	AH	
DWC-343P-21						8.000	5.702	2.298	336.0	AH	
DWC-343P-22	9.000	6.388	2.612	295.0	AI						
DWC-375P-14	1.937	2.000	1.125	0.375	1162.000	3.000	2.343	0.657	1755.0	AF	
DWC-375P-16						4.000	3.047	0.953	1217.0	AG	
DWC-375P-18						5.000	3.750	1.250	932.0	AG	
DWC-375P-19						6.000	4.453	1.547	755.0	AH	
DWC-375P-20						7.000	5.156	1.844	635.0	AH	
DWC-375P-21						8.000	5.859	2.141	547.0	AI	
DWC-375P-22	9.000	6.562	2.438	481.0	AJ						
DWC-207PQ-16	2.187	2.250	1.718	0.207	176.000	4.000	1.449	2.551	68.0	AA	
DWC-207PQ-18						5.000	1.708	3.292	54.4	AA	
DWC-207PQ-19						6.000	2.018	3.982	43.8	AB	
DWC-207PQ-20						7.000	2.277	4.723	37.7	AB	
DWC-207PQ-21						8.000	2.587	5.413	32.3	AC	
DWC-207PQ-22						9.000	2.898	6.102	28.3	AD	
DWC-207PQ-23	10.000	3.156	6.844	25.6	AD						
DWC-218PQ-16	2.187	2.250	1.718	0.218	194.000	4.000	1.580	2.420	81.0	AA	
DWC-218PQ-18						5.000	1.907	3.093	63.0	AB	
DWC-218PQ-19						6.000	2.234	3.766	51.5	AC	
DWC-218PQ-20						7.000	2.561	4.439	43.6	AD	
DWC-218PQ-21						8.000	2.888	5.112	37.8	AE	
DWC-218PQ-22						9.000	3.215	5.785	33.3	AE	
DWC-218PQ-23	10.000	3.542	6.458	29.8	AE						
DWC-250PQ-16	2.187	2.250	1.625	0.250	274.000	4.000	1.937	2.063	134.4	AC	
DWC-250PQ-18						5.000	2.375	2.625	103.0	AD	
DWC-250PQ-19						6.000	2.750	3.250	85.8	AE	
DWC-250PQ-20						7.000	3.187	3.813	71.9	AE	
DWC-250PQ-21						8.000	3.625	4.375	61.8	AF	
DWC-250PQ-22						9.000	4.000	5.000	55.2	AF	
DWC-250PQ-23	10.000	4.375	5.625	49.8	AF						
DWC-281PQ-16	2.187	2.250	1.562	0.281	377.000	4.000	2.248	1.752	215.7	AD	
DWC-281PQ-18						5.000	2.740	2.260	167.0	AE	
DWC-281PQ-19						6.000	3.231	2.769	136.3	AF	
DWC-281PQ-20						7.000	3.723	3.277	115.0	AF	
DWC-281PQ-21						8.000	4.215	3.785	99.6	AG	

Note: Wire Dia. up to .098" is Music Wire (MW); .105" and over is Oil Tempered Wire (OT). For prices from 1 to 100 see Price Index. Please inquire if you need a size not listed above.

STOCK COMPRESSION SPRINGS

Music Wire/Oil Tempered
(See Below)

Ends Squared and Ground Ends to
be Square Within 3 Degrees of Axis

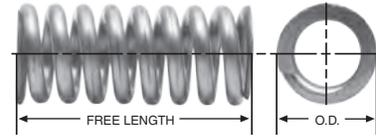

DIAMOND WIRE SPRING STOCK NO.	OUTSIDE DIAMETER	TO WORK IN HOLE DIA.	TO WORK OVER ROD DIA.	WIRE DIA.	APPROX. LOAD AT SOLID HT.	FREE LENGTH	SOLID HT.	TOTAL DEFLECTION	SPRING RATE	PRICE GROUP	
	IN.	IN.	IN.	IN.	LB.	IN.	IN.	IN.	LB./IN.	OT/MW	SS
DWC-281PQ-22	2.187	2.250	1.562	0.281	377.000	9.000	4.707	4.293	87.8	AG	
DWC-281PQ-23						10.000	5.198	4.802	78.4	AG	
DWC-312PQ-16	2.187	2.250	1.500	0.312	521.000	4.000	2.496	1.504	344.4	AF	
DWC-312PQ-18						5.000	3.042	1.958	266.6	AF	
DWC-312PQ-19						6.000	3.588	2.412	217.5	AG	
DWC-312PQ-20						7.000	4.150	2.850	182.9	AG	
DWC-312PQ-21						8.000	4.711	3.289	157.4	AG	
DWC-312PQ-22						9.000	5.265	3.735	138.9	AH	
DWC-312PQ-23						10.000	5.811	4.189	124.3	AI	
DWC-343PQ-16	2.187	2.250	1.437	0.343	733.000	4.000	2.658	1.342	551.8	AG	
DWC-343PQ-18						5.000	3.258	1.742	423.1	AG	
DWC-343PQ-19						6.000	3.859	2.141	343.0	AH	
DWC-343PQ-20						7.000	4.459	2.541	288.5	AH	
DWC-343PQ-21						8.000	5.059	2.941	248.9	AI	
DWC-343PQ-22						9.000	5.659	3.341	218.8	AI	
DWC-343PQ-23						10.000	6.260	3.740	195.3	AJ	
DWC-375PQ-16	2.187	2.250	1.375	0.375	907.000	4.000	2.906	1.094	831.0	AG	
DWC-375PQ-18						5.000	3.562	1.438	637.0	AG	
DWC-375PQ-19						6.000	4.237	1.763	513.7	AH	
DWC-375PQ-20						7.000	4.897	2.103	432.0	AI	
DWC-375PQ-21						8.000	5.569	2.431	371.8	AI	
DWC-375PQ-22						9.000	6.234	2.766	326.7	AJ	
DWC-375PQ-23						10.000	6.890	3.110	291.8	AK	
DWC-393PQ-16	2.187	2.250	1.343	0.393	1130.000	4.000	2.947	1.053	1080.0	AG	
DWC-393PQ-18						5.000	3.615	1.385	824.8	AH	
DWC-393PQ-19						6.000	4.303	1.697	663.5	AH	
DWC-393PQ-20						7.000	4.962	2.038	559.0	AI	
DWC-393PQ-21						8.000	5.649	2.351	480.0	AJ	
DWC-393PQ-22						9.000	6.311	2.689	422.0	AJ	
DWC-393PQ-23						10.000	6.995	3.005	375.9	AK	
DWC-281Q-16	2.437	2.500	1.750	0.281	338.000	4.000	2.037	1.963	170.0	AF	
DWC-281Q-18						5.000	2.459	2.541	132.0	AF	
DWC-281Q-19						6.000	2.880	3.120	108.0	AF	
DWC-281Q-20						7.000	3.302	3.698	92.0	AG	
DWC-281Q-21						8.000	3.723	4.277	79.0	AG	
DWC-281Q-23						10.000	4.566	5.434	63.0	AH	
DWC-312Q-16	2.437	2.500	1.687	0.312	470.000	4.000	2.262	1.738	270.0	AF	
DWC-312Q-18						5.000	2.730	2.270	210.0	AG	
DWC-312Q-19						6.000	3.237	2.763	169.0	AG	
DWC-312Q-20						7.000	3.744	3.256	142.0	AH	
DWC-312Q-21						8.000	4.212	3.788	123.0	AH	
DWC-312Q-23						10.000	5.148	4.852	98.0	AI	
DWC-343Q-16	2.437	2.500	1.625	0.343	620.000	4.000	2.487	1.513	412.0	AG	
DWC-343Q-18						5.000	3.044	1.956	315.0	AG	
DWC-343Q-19						6.000	3.601	2.399	255.0	AH	
DWC-343Q-20						7.000	4.116	2.884	217.0	AH	

COMPRESSION SPRINGS

Note: Wire Dia. up to .098" is Music Wire (MW); .105" and over is Oil Tempered Wire (OT). For prices from 1 to 100 see Price Index. Please inquire if you need a size not listed above.

STOCK COMPRESSION SPRINGS

Music Wire/Oil Tempered
(See Below)

Ends Squared and Ground Ends to
be Square Within 3 Degrees of Axis

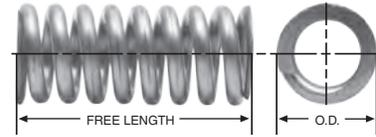

COMPRESSION SPRINGS

DIAMOND WIRE SPRING STOCK NO.	OUTSIDE DIAMETER	TO WORK IN HOLE DIA.	TO WORK OVER ROD DIA.	WIRE DIA.	APPROX. LOAD AT SOLID HT.	FREE LENGTH	SOLID HT.	TOTAL DEFLECTION	SPRING RATE	PRICE GROUP	
	IN.	IN.	IN.	IN.	LB.	IN.	IN.	IN.	LB./IN.	OT/MW	SS
DWC-343Q-21	2.437	2.500	1.625	0.343	620.000	8.000	4.673	3.327	186.0	AI	
DWC-343Q-23						10.000	5.745	4.255	147.0	AJ	
DWC-362Q-16	2.437	2.500	1.593	0.362	717.000	4.000	2.625	1.375	526.0	AG	
DWC-362Q-18						5.000	3.213	1.787	402.0	AH	
DWC-362Q-19						6.000	3.801	2.199	325.0	AI	
DWC-362Q-20						7.000	4.389	2.611	273.0	AI	
DWC-362Q-21						8.000	4.978	3.022	235.0	AJ	
DWC-362Q-23						10.000	6.109	3.891	186.0	AJ	
DWC-375Q-16	2.437	2.500	1.563	0.375	786.000	4.000	2.719	1.281	617.0	AH	
DWC-375Q-18						5.000	3.328	1.672	472.0	AH	
DWC-375Q-19						6.000	3.937	2.063	381.0	AI	
DWC-375Q-20						7.000	4.546	2.454	320.0	AJ	
DWC-375Q-21						8.000	5.156	2.844	276.0	AJ	
DWC-375Q-23						10.000	6.375	3.625	216.0	AK	
DWC-393Q-16	2.437	2.500	1.531	0.393	885.000	4.000	2.849	1.151	765.0	AH	
DWC-393Q-18						5.000	3.488	1.512	584.0	AH	
DWC-393Q-19						6.000	4.126	1.874	472.0	AI	
DWC-393Q-20						7.000	4.765	2.235	396.0	AJ	
DWC-393Q-21						8.000	5.404	2.596	342.0	AK	
DWC-393Q-23						10.000	6.681	3.319	268.0	AK	
DWC-406Q-16	2.437	2.500	1.500	0.406	1071.000	4.000	2.842	1.158	932.0	AI	
DWC-406Q-18						5.000	3.502	1.498	704.0	AI	
DWC-406Q-19						6.000	4.111	1.889	574.0	AJ	
DWC-406Q-20						7.000	4.770	2.230	478.0	AK	
DWC-406Q-21						8.000	5.380	2.620	414.0	AK	
DWC-406Q-23						10.000	6.699	3.301	322.0	AL	
DWC-437Q-16	2.437	2.500	1.437	0.437	1232.000	4.000	3.059	0.941	1310.0	AI	
DWC-437Q-18						5.000	3.769	1.231	989.0	AJ	
DWC-437Q-19						6.000	4.479	1.521	794.0	AJ	
DWC-437Q-20						7.000	5.189	1.811	664.0	AK	
DWC-437Q-21						8.000	5.856	2.144	575.0	AL	
DWC-437Q-23						10.000	7.265	2.735	448.0	AO	
DWC-312QR-16	2.687	2.750	2.000	0.312	445.000	4.000	2.028	1.972	226.0	AG	
DWC-312QR-18						5.000	2.433	2.567	175.3	AG	
DWC-312QR-19						6.000	2.848	3.152	142.6	AG	
DWC-312QR-20						7.000	3.276	3.724	119.6	AH	
DWC-312QR-21						8.000	3.666	4.334	104.3	AH	
DWC-312QR-22						9.000	4.118	4.882	90.8	AI	
DWC-312QR-23						10.000	4.524	5.476	81.3	AI	
DWC-343QR-16	2.687	2.750	1.937	0.343	604.000	4.000	2.230	1.770	343.3	AG	
DWC-343QR-18						5.000	2.709	2.291	261.8	AH	
DWC-343QR-19						6.000	3.173	2.827	213.0	AI	
DWC-343QR-20						7.000	3.636	3.364	179.6	AI	
DWC-343QR-21						8.000	4.081	3.919	156.0	AI	
DWC-343QR-22						9.000	4.545	4.455	137.3	AJ	
DWC-343QR-23						10.000	5.042	4.958	121.6	AJ	

Note: Wire Dia. up to .098" is Music Wire (MW); .105" and over is Oil Tempered Wire (OT). For prices from 1 to 100 see Price Index. Please inquire if you need a size not listed above.

STOCK COMPRESSION SPRINGS

Music Wire/Oil Tempered
(See Below)

Ends Squared and Ground Ends to
be Square Within 3 Degrees of Axis

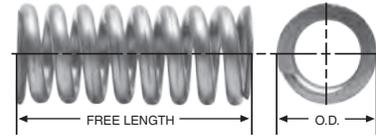

DIAMOND WIRE SPRING STOCK NO.	OUTSIDE DIAMETER	TO WORK IN HOLE DIA.	TO WORK OVER ROD DIA.	WIRE DIA.	APPROX. LOAD AT SOLID HT.	FREE LENGTH	SOLID HT.	TOTAL DEFLECTION	SPRING RATE	PRICE GROUP	
	IN.	IN.	IN.	IN.	LB.	IN.	IN.	IN.	LB./IN.	OT/MW	SS
DWC-362QR-16	2.687	2.750	1.875	0.362	718.000	4.000	2.353	1.647	436.5	AH	
DWC-362QR-18						5.000	2.851	2.149	334.3	AH	
DWC-362QR-19						6.000	3.348	2.652	271.0	AI	
DWC-362QR-20						7.000	3.846	3.154	227.7	AI	
DWC-362QR-21						8.000	4.344	3.656	196.4	AJ	
DWC-362QR-22						9.000	4.842	4.158	172.6	AJ	
DWC-362QR-23						10.000	5.340	4.660	154.0	AK	
DWC-375QR-16	2.687	2.750	1.875	0.375	804.000	4.000	2.437	1.563	511.1	AH	
DWC-375QR-18						5.000	2.953	2.047	391.5	AH	
DWC-375QR-19						6.000	3.469	2.531	317.3	AI	
DWC-375QR-20						7.000	3.984	3.016	266.7	AI	
DWC-375QR-21						8.000	4.500	3.500	230.0	AJ	
DWC-375QR-22						9.000	5.015	3.985	202.2	AJ	
DWC-375QR-23						10.000	5.531	4.469	180.4	AK	
DWC-393QR-16	2.687	2.750	1.750	0.393	912.000	4.000	2.550	1.450	631.2	AH	
DWC-393QR-18						5.000	3.105	1.895	481.4	AI	
DWC-393QR-19						6.000	3.655	2.345	389.1	AJ	
DWC-393QR-20						7.000	4.205	2.795	326.5	AJ	
DWC-393QR-21						8.000	4.755	3.245	281.2	AK	
DWC-393QR-22						9.000	5.305	3.695	247.0	AK	
DWC-393QR-23						10.000	5.856	4.144	220.2	AK	
DWC-406QR-17	2.687	2.750	1.750	0.406	972.000	4.500	2.943	1.557	626.8	AI	
DWC-406QR-18						5.000	3.248	1.752	548.5	AJ	
DWC-406QR-19						6.000	3.816	2.184	444.7	AJ	
DWC-406QR-20						7.000	4.384	2.616	374.0	AK	
DWC-406QR-21						8.000	4.973	3.027	321.1	AL	
DWC-406QR-22						9.000	5.532	3.468	283.1	AL	
DWC-406QR-23						10.000	6.131	3.869	251.2	AN	
DWC-437QR-17	2.687	2.750	1.750	0.437	1156.000	4.500	3.168	1.332	876.6	AJ	
DWC-437QR-18						5.000	3.496	1.504	767.0	AJ	
DWC-437QR-19						6.000	4.130	1.870	617.8	AK	
DWC-437QR-20						7.000	4.763	2.237	517.1	AK	
DWC-437QR-21						8.000	5.397	2.603	444.7	AL	
DWC-437QR-22						9.000	6.031	2.969	390.0	AO	
DWC-437QR-23						10.000	6.664	3.336	347.3	AO	
DWC-468QR-17	2.687	2.750	1.625	0.468	1548.000	4.500	3.276	1.224	1262.2	AO	
DWC-468QR-18						5.000	3.604	1.396	1107.2	AP	
DWC-468QR-19						6.000	4.258	1.742	890.0	AP	
DWC-468QR-20						7.000	4.914	2.086	742.5	AR	
DWC-468QR-21						8.000	5.569	2.431	637.5	AR	
DWC-468QR-22						9.000	6.224	2.776	558.5	AT	
DWC-468QR-23						10.000	6.879	3.121	497.0	AT	
DWC-281R-16	2.906	3.000	2.218	0.281	260.000	4.000	1.756	2.244	116.0	AF	
DWC-281R-18						5.000	2.107	2.893	90.0	AF	
DWC-281R-19						6.000	2.459	3.541	73.0	AG	
DWC-281R-20						7.000	2.810	4.190	62.0	AG	
DWC-281R-21						8.000	3.161	4.839	53.0	AH	

Note: Wire Dia. up to .098" is Music Wire (MW); .105" and over is Oil Tempered Wire (OT). For prices from 1 to 100 see Price Index. Please inquire if you need a size not listed above.

STOCK COMPRESSION SPRINGS

Music Wire/Oil Tempered
(See Below)

Ends Squared and Ground Ends to
be Square Within 3 Degrees of Axis

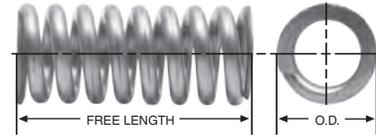

COMPRESSION SPRINGS

DIAMOND WIRE SPRING STOCK NO.	OUTSIDE DIAMETER	TO WORK IN HOLE DIA.	TO WORK OVER ROD DIA.	WIRE DIA.	APPROX. LOAD AT SOLID HT.	FREE LENGTH	SOLID HT.	TOTAL DEFLECTION	SPRING RATE	PRICE GROUP	
	IN.	IN.	IN.	IN.	LB.	IN.	IN.	IN.	LB./IN.	OT/MW	SS
DWC-281R-22	2.906	3.000	2.218	0.281	260.000	9.000	3.524	5.476	47.0	AH	
DWC-281R-23						10.000	3.864	6.136	42.0	AH	
DWC-312R-16	2.906	3.000	2.156	0.312	378.000	4.000	1.950	2.050	184.0	AG	
DWC-312R-18						5.000	2.340	2.660	142.0	AG	
DWC-312R-19						6.000	2.730	3.270	116.0	AH	
DWC-312R-20						7.000	3.120	3.880	98.0	AH	
DWC-312R-21						8.000	3.510	4.490	84.0	AI	
DWC-312R-22						9.000	3.914	5.086	74.0	AJ	
DWC-312R-23						10.000	4.290	5.710	66.0	AJ	
DWC-343R-16	2.906	3.000	2.093	0.343	512.000	4.000	2.144	1.856	278.0	AH	
DWC-343R-18						5.000	2.607	2.393	211.0	AI	
DWC-343R-19						6.000	3.040	2.960	172.0	AI	
DWC-343R-20						7.000	3.473	3.527	145.0	AJ	
DWC-343R-21						8.000	3.902	4.098	126.0	AJ	
DWC-343R-22						9.000	4.371	4.629	110.0	AK	
DWC-343R-23						10.000	4.802	5.198	98.0	AK	
DWC-362R-16	2.906	3.000	2.062	0.362	613.000	4.000	2.262	1.738	352.0	AI	
DWC-362R-18						5.000	2.715	2.285	273.0	AI	
DWC-362R-19						6.000	3.212	2.788	218.0	AJ	
DWC-362R-20						7.000	3.665	3.335	184.0	AJ	
DWC-362R-21						8.000	4.163	3.837	158.0	AK	
DWC-362R-22						9.000	4.629	4.371	139.0	AL	
DWC-362R-23	10.000	5.068	4.932	125.0	AL						
DWC-375R-16	2.906	3.000	2.032	0.375	675.000	4.000	2.343	1.657	412.0	AI	
DWC-375R-18						5.000	2.859	2.141	312.0	AI	
DWC-375R-19						6.000	3.321	2.679	255.0	AJ	
DWC-375R-20						7.000	3.844	3.156	213.0	AJ	
DWC-375R-21						8.000	4.312	3.688	185.0	AK	
DWC-375R-22						9.000	4.898	4.102	158.5	AL	
DWC-375R-23	10.000	5.344	4.656	143.0	AM						
DWC-393R-16	2.906	3.000	2.000	0.393	780.000	4.000	2.456	1.544	508.0	AI	
DWC-393R-18						5.000	2.997	2.003	384.0	AJ	
DWC-393R-19						6.000	3.498	2.502	313.0	AJ	
DWC-393R-20						7.000	4.028	2.972	262.0	AK	
DWC-393R-21						8.000	4.520	3.480	227.0	AK	
DWC-393R-22						9.000	5.163	3.837	194.0	AN	
DWC-393R-23	10.000	5.600	4.400	176.0	AO						
DWC-406R-18	2.906	3.000	2.000	0.406	805.000	5.000	3.146	1.854	435.0	AJ	
DWC-406R-19						6.000	3.705	2.295	351.0	AK	
DWC-406R-20						7.000	4.263	2.737	294.0	AK	
DWC-406R-21						8.000	4.821	3.179	253.0	AM	
DWC-406R-22						9.000	5.363	3.637	223.0	AN	
DWC-406R-23						10.000	5.937	4.063	198.0	AO	
DWC-406R-25	12.000	7.054	4.946	163.0	AP						
DWC-437R-18	2.906	3.000	1.875	0.437	1075.000	5.000	3.277	1.723	633.0	AJ	
DWC-437R-19						6.000	3.878	2.122	507.0	AK	
DWC-437R-20						7.000	4.479	2.521	422.0	AM	

Note: Wire Dia. up to .098" is Music Wire (MW); .105" and over is Oil Tempered Wire (OT). For prices from 1 to 100 see Price Index. Please inquire if you need a size not listed above.

STOCK COMPRESSION SPRINGS

Music Wire/Oil Tempered
(See Below)

Ends Squared and Ground Ends to
be Square Within 3 Degrees of Axis

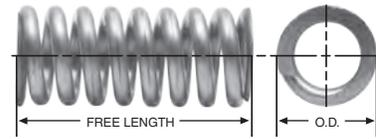

DIAMOND WIRE SPRING STOCK NO.	OUTSIDE DIAMETER	TO WORK IN HOLE DIA.	TO WORK OVER ROD DIA.	WIRE DIA.	APPROX. LOAD AT SOLID HT.	FREE LENGTH	SOLID HT.	TOTAL DEFLECTION	SPRING RATE	PRICE GROUP	
	IN.	IN.	IN.	IN.	LB.	IN.	IN.	IN.	LB./IN.	OT/MW	SS
DWC-437R-21	2.906	3.000	1.875	0.437	1075.000	8.000	5.025	2.975	367.0	AM	
DWC-437R-22						9.000	5.816	3.184	308.0	AN	
DWC-437R-23						10.000	6.227	3.773	284.0	AO	
DWC-437R-25						12.000	7.429	4.571	232.0	AP	
DWC-468R-18	2.906	3.000	1.875	0.468	1280.000	5.000	3.510	1.490	865.0	AP	
DWC-468R-19						6.000	4.153	1.847	692.0	AP	
DWC-468R-20						7.000	4.797	2.203	577.0	AR	
DWC-468R-21						8.000	5.440	2.560	494.0	AR	
DWC-468R-22						9.000	6.176	2.824	425.0	AS	
DWC-468R-23						10.000	6.669	3.331	388.0	AT	
DWC-468R-25	12.000	7.965	4.035	317.0	AW						
DWC-500R-18	2.906	3.000	1.750	0.500	1671.000	5.000	3.625	1.375	1228.0	AP	
DWC-500R-19						6.000	4.300	1.700	977.0	AR	
DWC-500R-20						7.000	4.937	2.063	819.0	AR	
DWC-500R-21						8.000	5.625	2.375	697.0	AT	
DWC-500R-22						9.000	6.331	2.669	605.0	AU	
DWC-500R-23						10.000	6.937	3.063	543.0	AW	
DWC-500R-25	12.000	8.250	3.750	445.0	AW						
DWC-531R-18	2.906	3.000	1.750	0.531	1847.000	5.000	3.850	1.150	1625.0	AR	
DWC-531R-19						6.000	4.580	1.420	1288.0	AR	
DWC-531R-20						7.000	5.283	1.717	1073.0	AT	
DWC-531R-22						9.000	6.760	2.240	795.0	AU	
DWC-531R-21						8.000	5.974	2.026	922.0	AW	
DWC-531R-23						10.000	7.434	2.566	711.0	AZ	
DWC-531R-25	12.000	8.828	3.172	583.0	AZ						
DWC-343RS-18	3.156	3.250	2.250	0.343	468.000	5.000	2.400	2.600	178.8	AI	
DWC-343RS-19						6.000	2.787	3.213	146.0	AI	
DWC-343RS-20						7.000	3.173	3.827	123.3	AJ	
DWC-343RS-21						8.000	3.601	4.399	105.2	AJ	
DWC-343RS-22						9.000	4.055	4.945	91.0	AK	
DWC-343RS-23						10.000	4.373	5.627	83.1	AK	
DWC-343RS-25	12.000	5.145	6.855	68.7	AM						
DWC-362RS-18	3.156	3.250	2.250	0.362	565.000	5.000	2.534	2.466	226.3	AI	
DWC-362RS-19						6.000	2.941	3.059	184.8	AI	
DWC-362RS-20						7.000	3.348	3.652	156.1	AJ	
DWC-362RS-21						8.000	3.801	4.199	133.1	AK	
DWC-362RS-22						9.000	4.287	4.713	115.0	AK	
DWC-362RS-23						10.000	4.615	5.385	105.3	AK	
DWC-362RS-25	12.000	5.520	6.480	85.4	AM						
DWC-375RS-18	3.156	3.250	2.343	0.375	626.000	5.000	2.625	2.375	264.3	AI	
DWC-375RS-19						6.000	3.093	2.907	211.5	AJ	
DWC-375RS-20						7.000	3.515	3.485	179.2	AJ	
DWC-375RS-21						8.000	3.937	4.063	155.5	AK	
DWC-375RS-22						9.000	4.477	4.523	133.0	AL	
DWC-375RS-23						10.000	4.824	5.176	121.5	AM	
DWC-375RS-25	12.000	5.718	6.282	99.7	AO						

Note: Wire Dia. up to .098" is Music Wire (MW); .105" and over is Oil Tempered Wire (OT). For prices from 1 to 100 see Price Index. Please inquire if you need a size not listed above.

STOCK COMPRESSION SPRINGS

Music Wire/Oil Tempered
(See Below)

Ends Squared and Ground Ends to
be Square Within 3 Degrees of Axis

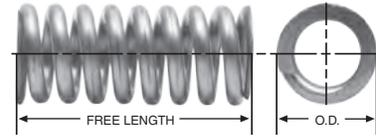

COMPRESSION SPRINGS

DIAMOND WIRE SPRING STOCK NO.	OUTSIDE DIAMETER	TO WORK IN HOLE DIA.	TO WORK OVER ROD DIA.	WIRE DIA.	APPROX. LOAD AT SOLID HT.	FREE LENGTH	SOLID HT.	TOTAL DEFLECTION	SPRING RATE	PRICE GROUP	
	IN.	IN.	IN.	IN.	LB.	IN.	IN.	IN.	LB./IN.	OT/MW	SS
DWC-393RS-18	3.156	3.250	2.343	0.393	737.000	5.000	2.751	2.249	325.1	AJ	
DWC-393RS-19						6.000	3.222	2.778	260.1	AJ	
DWC-393RS-20						7.000	3.684	3.316	220.4	AK	
DWC-393RS-21						8.000	4.126	3.874	191.2	AK	
DWC-393RS-22						9.000	4.730	4.270	162.0	AL	
DWC-393RS-23						10.000	5.060	4.940	149.5	AM	
DWC-393RS-25	12.000	5.993	6.007	122.7	AO						
DWC-406RS-18	3.156	3.250	2.250	0.406	809.000	5.000	2.842	2.158	375.6	AJ	
DWC-406RS-19						6.000	3.329	2.671	350.0	AJ	
DWC-406RS-20						7.000	3.806	3.194	254.6	AK	
DWC-406RS-21						8.000	4.503	3.497	218.4	AM	
DWC-406RS-22						9.000	4.934	4.066	185.0	AN	
DWC-406RS-23						10.000	5.278	4.722	170.7	AO	
DWC-406RS-25	12.000	6.252	5.748	140.1	AP						
DWC-437RS-18	3.156	3.250	2.187	0.437	1019.000	5.000	3.059	1.941	521.6	AJ	
DWC-437RS-19						6.000	3.583	2.417	420.6	AK	
DWC-437RS-20						7.000	4.108	2.892	352.4	AM	
DWC-437RS-21						8.000	4.632	3.368	303.5	AO	
DWC-437RS-22						9.000	5.309	3.691	257.0	AP	
DWC-437RS-23						10.000	5.681	4.319	237.1	AP	
DWC-437RS-25	12.000	6.773	5.227	193.2	AP						
DWC-468RS-18	3.156	3.250	2.125	0.468	1215.000	5.000	3.276	1.724	710.0	AP	
DWC-468RS-19						6.000	3.861	2.139	568.1	AP	
DWC-468RS-20						7.000	4.446	2.554	473.4	AR	
DWC-468RS-21						8.000	5.008	2.992	408.1	AT	
DWC-468RS-22						9.000	5.725	3.275	347.0	AT	
DWC-468RS-23						10.000	6.177	3.823	317.0	AT	
DWC-468RS-25	12.000	7.312	4.688	260.1	AW						
DWC-500RS-18	3.156	3.250	2.00	0.500	1438.000	5.000	3.500	1.500	959.0	AP	
DWC-500RS-19						6.000	4.125	1.875	767.2	AR	
DWC-500RS-20						7.000	4.750	2.250	639.4	AT	
DWC-500RS-21						8.000	5.375	2.625	548.0	AT	
DWC-500RS-22						9.000	6.090	2.910	471.0	AU	
DWC-500RS-23						10.000	6.625	3.375	426.2	AW	
DWC-500RS-25	12.000	7.875	4.125	348.7	AZ						
DWC-531RS-18	3.156	3.250	2.000	0.531	1636.000	5.000	3.717	1.283	1263.6	AR	
DWC-531RS-19						6.000	4.381	1.619	1011.0	AT	
DWC-531RS-20						7.000	5.044	1.956	842.4	AW	
DWC-531RS-21						8.000	5.735	2.265	718.0	AW	
DWC-531RS-22						9.000	6.430	2.570	625.0	AX	
DWC-531RS-23						10.000	7.062	2.938	559.1	AZ	
DWC-531RS-25	12.000	8.416	3.584	456.2	AXC						
DWC-343S-19	3.406	3.500	2.593	0.343	424.000	6.000	2.572	3.428	121.0	AJ	
DWC-343S-20						7.000	2.948	4.052	105.0	AJ	
DWC-343S-21						8.000	3.344	4.656	89.0	AJ	
DWC-343S-22						9.000	3.692	5.308	79.0	AL	
DWC-343S-23						10.000	4.030	5.970	71.0	AM	

Note: Wire Dia. up to .098" is Music Wire (MW); .105" and over is Oil Tempered Wire (OT). For prices from 1 to 100 see Price Index. Please inquire if you need a size not listed above.

STOCK COMPRESSION SPRINGS

Music Wire/Oil Tempered
(See Below)

Ends Squared and Ground Ends to
be Square Within 3 Degrees of Axis

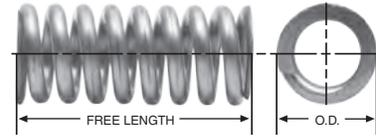

DIAMOND WIRE SPRING STOCK NO.	OUTSIDE DIAMETER	TO WORK IN HOLE DIA.	TO WORK OVER ROD DIA.	WIRE DIA.	APPROX. LOAD AT SOLID HT.	FREE LENGTH	SOLID HT.	TOTAL DEFLECTION	SPRING RATE	PRICE GROUP	
	IN.	IN.	IN.	IN.	LB.	IN.	IN.	IN.	LB./IN.	OT/MW	SS
DWC-343S-25	3.406	3.500	2.593	0.343	424.000	12.000	4.716	7.284	59.0	AM	
DWC-343S-27						14.000	5.486	8.514	49.0	AO	
DWC-343S-29						16.000	6.174	9.826	43.0	AO	
DWC-362S-19	3.406	3.500	2.562	0.362	480.000	6.000	2.805	3.195	152.0	AJ	
DWC-362S-20						7.000	3.219	3.781	127.0	AK	
DWC-362S-21						8.000	3.620	4.380	109.0	AK	
DWC-362S-22						9.000	4.024	4.976	96.0	AL	
DWC-362S-23						10.000	4.434	5.566	85.0	AM	
DWC-362S-25						12.000	5.158	6.842	71.0	AO	
DWC-362S-27						14.000	5.882	8.118	59.0	AP	
DWC-362S-29						16.000	6.787	9.213	52.0	AP	
DWC-375S-19	3.406	3.500	2.531	0.375	540.000	6.000	2.906	3.094	177.0	AJ	
DWC-375S-20						7.000	3.337	3.663	148.0	AK	
DWC-375S-21						8.000	3.750	4.250	127.0	AK	
DWC-375S-22						9.000	4.168	4.832	112.0	AL	
DWC-375S-23						10.000	4.594	5.406	100.0	AM	
DWC-375S-25						12.000	5.437	6.563	82.0	AO	
DWC-375S-27						14.000	6.281	7.719	69.0	AP	
DWC-375S-29						16.000	7.031	8.969	61.0	AR	
DWC-393S-19	3.406	3.500	2.500	0.393	607.000	6.000	3.144	2.856	209.0	AL	
DWC-393S-20						7.000	3.585	3.415	176.0	AM	
DWC-393S-21						8.000	4.028	3.972	152.0	AM	
DWC-393S-22						9.000	4.463	4.537	134.0	AN	
DWC-393S-23						10.000	4.912	5.088	119.0	AO	
DWC-393S-25						12.000	5.797	6.203	98.0	AP	
DWC-393S-27						14.000	6.681	7.319	84.0	AP	
DWC-393S-29						16.000	7.565	8.435	73.0	AR	
DWC-406S-19	3.406	3.500	2.468	0.406	669.000	6.000	3.248	2.752	241.0	AK	
DWC-406S-20						7.000	3.720	3.280	202.0	AL	
DWC-406S-21						8.000	4.161	3.839	175.0	AM	
DWC-406S-22						9.000	4.651	4.349	153.0	AN	
DWC-406S-23						10.000	5.075	4.925	138.0	AO	
DWC-406S-25						12.000	6.039	5.961	112.0	AP	
DWC-406S-27						14.000	7.000	7.000	95.0	AR	
DWC-406S-29						16.000	7.917	8.083	83.0	AT	
DWC-437S-19	3.406	3.500	2.406	0.437	865.000	6.000	3.441	2.559	341.0	AM	
DWC-437S-20						7.000	3.978	3.022	282.0	AN	
DWC-437S-21						8.000	4.479	3.521	243.0	AO	
DWC-437S-22						9.000	5.003	3.997	212.0	AP	
DWC-437S-23						10.000	5.462	4.538	191.0	AP	
DWC-437S-25						12.000	6.446	5.554	157.0	AR	
DWC-437S-27						14.000	7.484	6.516	132.0	AT	
DWC-437S-29						16.000	8.467	7.533	115.0	AW	
DWC-468S-19	3.406	3.500	2.375	0.468	1131.000	6.000	3.627	2.373	473.0	AR	
DWC-468S-20						7.000	4.303	2.697	378.0	AR	
DWC-468S-21						8.000	4.680	3.320	340.0	AR	
DWC-468S-22						9.000	5.279	3.721	293.0	AS	

Note: Wire Dia. up to .098" is Music Wire (MW); .105" and over is Oil Tempered Wire (OT). For prices from 1 to 100 see Price Index. Please inquire if you need a size not listed above.

STOCK COMPRESSION SPRINGS

Music Wire/Oil Tempered
(See Below)

Ends Squared and Ground Ends to
be Square Within 3 Degrees of Axis

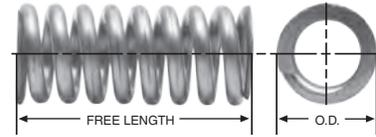

COMPRESSION SPRINGS

DIAMOND WIRE SPRING STOCK NO.	OUTSIDE DIAMETER	TO WORK IN HOLE DIA.	TO WORK OVER ROD DIA.	WIRE DIA.	APPROX. LOAD AT SOLID HT.	FREE LENGTH	SOLID HT.	TOTAL DEFLECTION	SPRING RATE	PRICE GROUP	
	IN.	IN.	IN.	IN.	LB.	IN.	IN.	IN.	LB./IN.	OT/MW	SS
DWC-468S-23	3.406	3.500	2.375	0.468	1131.000	10.000	5.733	4.267	265.0	AT	
DWC-468S-25						12.000	6.786	5.214	218.0	AW	
DWC-468S-27						14.000	7.839	6.161	184.0	AZ	
DWC-468S-29						16.000	8.892	7.108	160.0	AZ	
DWC-500S-19	3.406	3.500	2.312	0.500	1354.000	6.000	3.875	2.125	637.0	AR	
DWC-500S-20						7.000	4.596	2.404	509.0	AS	
DWC-500S-21						8.000	5.000	3.000	457.0	AT	
DWC-500S-22						9.000	5.634	3.366	395.0	AU	
DWC-500S-23						10.000	6.187	3.813	353.0	AW	
DWC-500S-25						12.000	7.312	4.688	290.0	AZ	
DWC-500S-27						14.000	8.500	5.500	244.0	AXC	
DWC-500S-29						16.000	9.625	6.375	212.0	AXE	
DWC-531S-19	3.406	3.500	2.218	0.531	1661.000	6.000	4.049	1.951	855.0	AT	
DWC-531S-20						7.000	4.726	2.274	697.0	AU	
DWC-531S-21						8.000	5.257	2.743	608.0	AW	
DWC-531S-22						9.000	5.973	3.027	520.0	AX	
DWC-531S-23						10.000	6.505	3.495	469.0	AZ	
DWC-531S-25						12.000	7.700	4.300	385.0	AXC	
DWC-531S-27						14.000	8.894	5.106	326.0	AXE	
DWC-531S-29						16.000	10.089	5.911	283.0	AXI	
DWC-562S-19	3.406	3.500	2.125	0.562	1868.000	6.000	4.300	1.700	1103.0	AW	
DWC-562S-20						7.000	4.995	2.005	905.0	AX	
DWC-562S-21						8.000	5.620	2.380	779.0	AZ	
DWC-562S-22						9.000	6.314	2.686	675.0	AXB	
DWC-562S-23						10.000	6.885	3.115	608.0	AXC	
DWC-562S-25						12.000	8.219	3.781	494.0	AXE	
DWC-562S-27						14.000	9.554	4.446	416.0	AXI	
DWC-562S-29						16.000	10.818	5.182	361.0	AXK	
DWC-593S-19	3.406	3.500	2.095	0.593	2319.000	6.000	4.418	1.582	1465.0	AZ	
DWC-593S-20						7.000	5.186	1.814	1184.0	AZ	
DWC-593S-21						8.000	5.752	2.248	1037.0	AZ	
DWC-593S-22						9.000	6.537	2.463	885.0	AXC	
DWC-593S-23						10.000	7.116	2.884	798.0	AXE	
DWC-593S-25						12.000	8.450	3.550	652.0	AXI	
DWC-593S-27						14.000	9.785	4.215	551.0	AXK	
DWC-593S-29						16.000	11.119	4.881	477.0	AXL	
DWC-362ST-19	3.656	3.750	2.875	0.362	469.000	6.000	2.534	3.466	138.1	AJ	
DWC-362ST-20						7.000	2.896	4.104	115.1	AK	
DWC-362ST-21						8.000	3.258	4.742	98.6	AK	
DWC-362ST-22						9.000	3.665	5.335	85.0	AL	
DWC-362ST-23						10.000	3.909	6.091	78.4	AM	
DWC-362ST-25						12.000	4.615	7.385	64.2	AO	
DWC-362ST-27						14.000	5.340	8.660	54.2	AO	
DWC-362ST-29						16.000	6.063	9.937	46.8	AP	
DWC-375ST-19	3.656	3.750	2.750	0.375	550.000	6.000	2.625	3.375	161.0	AJ	
DWC-375ST-20						7.000	3.047	3.953	131.4	AK	

Note: Wire Dia. up to .098" is Music Wire (MW); .105" and over is Oil Tempered Wire (OT). For prices from 1 to 100 see Price Index. Please inquire if you need a size not listed above.

STOCK COMPRESSION SPRINGS

Music Wire/Oil Tempered
(See Below)

Ends Squared and Ground Ends to
be Square Within 3 Degrees of Axis

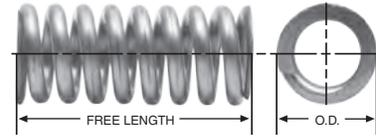

DIAMOND WIRE SPRING STOCK NO.	OUTSIDE DIAMETER	TO WORK IN HOLE DIA.	TO WORK OVER ROD DIA.	WIRE DIA.	APPROX. LOAD AT SOLID HT.	FREE LENGTH	SOLID HT.	TOTAL DEFLECTION	SPRING RATE	PRICE GROUP	
	IN.	IN.	IN.	IN.	LB.	IN.	IN.	IN.	LB./IN.	OT/MW	SS
DWC-375ST-21	3.656	3.750	2.750	0.375	550.000	8.000	3.337	4.663	116.6	AK	
DWC-375ST-22						9.000	3.768	5.232	100.0	AL	
DWC-375ST-23						10.000	4.012	5.988	92.5	AM	
DWC-375ST-25						12.000	4.734	7.266	75.7	AO	
DWC-375ST-27						14.000	5.484	8.516	63.7	AP	
DWC-375ST-29						16.000	6.187	9.813	55.5	AR	
DWC-393ST-19	3.656	3.750	2.750	0.393	642.000	6.000	2.751	3.249	197.4	AK	
DWC-393ST-20						7.000	3.242	3.758	157.9	AL	
DWC-393ST-21						8.000	3.498	4.502	143.0	AM	
DWC-393ST-22						9.000	4.018	4.982	120.0	AN	
DWC-393ST-23						10.000	4.244	5.756	112.1	AO	
DWC-393ST-25						12.000	5.011	6.989	91.8	AO	
DWC-393ST-27						14.000	5.777	8.223	77.7	AP	
DWC-393ST-29						16.000	6.533	9.467	67.5	AR	
DWC-406ST-19	3.656	3.750	2.750	0.406	722.000	6.000	2.842	3.158	227.5	AK	
DWC-406ST-20						7.000	3.400	3.600	178.5	AL	
DWC-406ST-21						8.000	3.613	4.387	164.9	AM	
DWC-406ST-22						9.000	4.184	4.816	137.0	AN	
DWC-406ST-23						10.000	4.385	5.615	129.3	AO	
DWC-406ST-25						12.000	5.176	6.824	105.8	AP	
DWC-406ST-27						14.000	5.968	8.032	89.6	AR	
DWC-406ST-29						16.000	6.750	9.250	77.8	AT	
DWC-437ST-19	3.656	3.750	2.718	0.437	855.000	6.000	3.168	2.832	299.4	AM	
DWC-437ST-20						7.000	3.715	3.286	241.8	AN	
DWC-437ST-21						8.000	4.042	3.958	216.8	AO	
DWC-437ST-22						9.000	4.627	4.373	183.0	AP	
DWC-437ST-23						10.000	4.938	5.062	169.0	AP	
DWC-437ST-25						12.000	5.834	6.166	138.5	AR	
DWC-437ST-27						14.000	6.708	7.292	117.7	AT	
DWC-437ST-29						16.000	7.604	8.396	102.0	AW	
DWC-468ST-19	3.656	3.750	2.656	0.468	1056.000	6.000	3.393	2.607	405.4	AR	
DWC-468ST-20						7.000	4.037	2.964	321.3	AS	
DWC-468ST-21						8.000	4.352	3.648	291.6	AT	
DWC-468ST-22						9.000	4.920	4.080	250.0	AU	
DWC-468ST-23						10.000	5.335	4.665	226.4	AW	
DWC-468ST-25						12.000	6.318	5.682	185.0	AW	
DWC-468ST-27						14.000	7.254	6.746	157.6	AZ	
DWC-468ST-29						16.000	8.236	7.764	136.4	AXC	
DWC-500ST-19	3.656	3.750	2.500	0.500	1302.000	6.000	3.625	2.375	544.4	AR	
DWC-500ST-20						7.000	4.375	2.625	423.4	AS	
DWC-500ST-21						8.000	4.675	3.325	388.8	AT	
DWC-500ST-22						9.000	5.304	3.696	332.0	AU	
DWC-500ST-23						10.000	5.700	4.300	304.0	AW	
DWC-500ST-25						12.000	6.750	5.250	248.5	AZ	
DWC-500ST-27						14.000	7.800	6.200	210.1	AXC	
DWC-500ST-29						16.000	8.875	7.125	181.5	AXE	

Note: Wire Dia. up to .098" is Music Wire (MW); .105" and over is Oil Tempered Wire (OT). For prices from 1 to 100 see Price Index. Please inquire if you need a size not listed above.

STOCK COMPRESSION SPRINGS

Music Wire/Oil Tempered
(See Below)

Ends Squared and Ground Ends to
be Square Within 3 Degrees of Axis

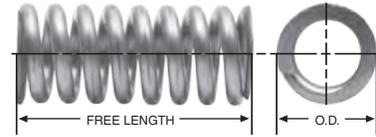

COMPRESSION SPRINGS

DIAMOND WIRE SPRING STOCK NO.	OUTSIDE DIAMETER	TO WORK IN HOLE DIA.	TO WORK OVER ROD DIA.	WIRE DIA.	APPROX. LOAD AT SOLID HT.	FREE LENGTH	SOLID HT.	TOTAL DEFLECTION	SPRING RATE	PRICE GROUP	
	IN.	IN.	IN.	IN.	LB.	IN.	IN.	IN.	LB./IN.	OT/MW	SS
DWC-531ST-19	3.656	3.750	2.437	0.531	1534.000	6.000	3.850	2.150	713.3	AU	
DWC-531ST-20						7.000	4.646	2.354	554.8	AU	
DWC-531ST-21						8.000	4.991	3.009	506.0	AU	
DWC-531ST-22						9.000	5.602	3.398	438.0	AX	
DWC-531ST-23						10.000	6.106	3.894	394.2	AZ	
DWC-531ST-25						12.000	7.222	4.778	322.8	AXC	
DWC-531ST-27						14.000	8.363	5.637	272.3	AXE	
DWC-531ST-29						16.000	9.478	6.522	236.3	AXI	
DWC-562ST-19	3.656	3.750	2.437	0.562	1779.000	6.000	4.074	1.926	922.2	AW	
DWC-562ST-20						7.000	4.918	2.083	717.3	AX	
DWC-562ST-21						8.000	5.269	2.731	656.5	AXA	
DWC-562ST-22						9.000	5.940	3.060	565.0	AXC	
DWC-562ST-23						10.000	6.491	3.509	507.0	AXD	
DWC-562ST-25						12.000	7.727	4.273	412.0	AXF	
DWC-562ST-27						14.000	8.922	5.078	349.0	AXI	
DWC-562ST-29						16.000	10.116	5.884	302.6	AXK	
DWC-593ST-19	3.656	3.750	2.406	0.593	2148.000	6.000	4.225	1.775	1207.0	AZ	
DWC-593ST-20						7.000	5.189	1.811	916.4	AXB	
DWC-593ST-21						8.000	5.485	2.515	853.2	AXC	
DWC-593ST-22						9.000	3.665	5.335	85.0	AXD	
DWC-593ST-23						10.000	6.745	3.255	659.8	AXE	
DWC-593ST-25						12.000	8.005	3.995	537.9	AXI	
DWC-593ST-27						14.000	9.265	4.735	454.0	AXK	
DWC-593ST-29						16.000	10.526	5.474	392.7	AXM	
DWC-375T-19	3.906	4.000	3.031	0.375	476.000	6.000	2.531	3.469	136.0	AM	
DWC-375T-20						7.000	2.837	4.163	116.0	AM	
DWC-375T-21						8.000	3.187	4.813	99.0	AM	
DWC-375T-22						9.000	3.599	5.401	85.0	AO	
DWC-375T-23						10.000	3.844	6.156	78.0	AP	
DWC-375T-25						12.000	4.500	7.500	65.0	AP	
DWC-375T-27						14.000	5.250	8.750	54.0	AR	
DWC-375T-29						16.000	5.906	10.094	47.0	AS	
DWC-393T-19	3.906	4.000	3.000	0.393	567.000	6.000	2.604	3.396	171.0	AM	
DWC-393T-20						7.000	3.006	3.994	140.0	AN	
DWC-393T-21						8.000	3.340	4.660	122.0	AO	
DWC-393T-22						9.000	3.833	5.167	102.0	AP	
DWC-393T-23						10.000	4.028	5.972	96.0	AP	
DWC-393T-25						12.000	4.716	7.284	79.0	AQ	
DWC-393T-27						14.000	5.502	8.498	66.0	AR	
DWC-393T-29						16.000	6.190	9.810	57.0	AT	
DWC-406T-19	3.906	4.000	2.968	0.406	612.000	6.000	2.740	3.260	190.0	AM	
DWC-406T-20						7.000	3.248	3.752	151.8	AN	
DWC-406T-21						8.000	3.502	4.498	136.0	AO	
DWC-406T-22						9.000	3.946	5.054	118.0	AP	
DWC-406T-23						10.000	4.263	5.737	107.0	AQ	
DWC-406T-25						12.000	4.973	7.027	88.0	AR	

Note: Wire Dia. up to .098" is Music Wire (MW); .105" and over is Oil Tempered Wire (OT). For prices from 1 to 100 see Price Index. Please inquire if you need a size not listed above.

STOCK COMPRESSION SPRINGS

Music Wire/Oil Tempered
(See Below)

Ends Squared and Ground Ends to
be Square Within 3 Degrees of Axis

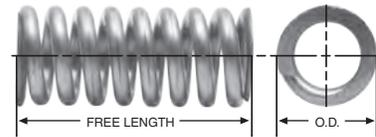

DIAMOND WIRE SPRING STOCK NO.	OUTSIDE DIAMETER	TO WORK IN HOLE DIA.	TO WORK OVER ROD DIA.	WIRE DIA.	APPROX. LOAD AT SOLID HT.	FREE LENGTH	SOLID HT.	TOTAL DEFLECTION	SPRING RATE	PRICE GROUP	
	IN.	IN.	IN.	IN.	LB.	IN.	IN.	IN.	LB./IN.	OT/MW	SS
DWC-406T-27	3.906	4.000	2.968	0.406	612.000	14.000	5.785	8.215	74.0	AT	
DWC-406T-29						16.000	6.496	9.504	64.0	AW	
DWC-437T-19	3.906	4.000	2.906	0.437	770.000	6.000	3.084	2.916	258.0	AM	
DWC-437T-20						7.000	3.496	3.504	209.3	AN	
DWC-437T-21						8.000	3.824	4.176	186.0	AO	
DWC-437T-22						9.000	4.369	4.631	157.0	AP	
DWC-437T-23						10.000	4.698	5.302	143.0	AQ	
DWC-437T-25						12.000	5.462	6.538	120.0	AR	
DWC-437T-27						14.000	6.336	7.664	100.0	AT	
DWC-437T-29						16.000	7.210	8.790	87.0	AW	
DWC-468T-19	3.906	4.000	2.844	0.468	915.000	6.000	3.276	2.724	339.0	AR	
DWC-468T-20						7.000	3.861	3.139	271.5	AS	
DWC-468T-21						8.000	4.212	3.788	242.0	AT	
DWC-468T-22						9.000	4.682	4.318	212.0	AU	
DWC-468T-23						10.000	5.148	4.852	189.0	AW	
DWC-468T-25						12.000	6.084	5.916	154.0	AZ	
DWC-468T-27						14.000	7.020	6.980	131.0	AZ	
DWC-468T-29						16.000	7.956	8.044	113.0	AXC	
DWC-500T-19	3.906	4.000	2.781	0.500	1137.000	6.000	3.500	2.500	455.0	AT	
DWC-500T-20						7.000	4.125	2.875	363.8	AU	
DWC-500T-21						8.000	4.500	3.500	325.0	AW	
DWC-500T-22						9.000	5.090	3.910	278.0	AX	
DWC-500T-23						10.000	5.500	4.500	253.0	AW	
DWC-500T-25						12.000	6.500	5.500	207.0	AZ	
DWC-500T-27						14.000	7.500	6.500	175.0	AXC	
DWC-500T-29						16.000	8.500	7.500	152.0	AXE	
DWC-531T-19	3.906	4.000	2.718	0.531	1372.000	6.000	3.717	2.283	595.0	AW	
DWC-531T-20						7.000	4.447	2.553	466.3	AX	
DWC-531T-21						8.000	4.779	3.221	425.0	AW	
DWC-531T-22						9.000	5.387	3.613	365.0	AX	
DWC-531T-23						10.000	5.841	4.159	330.0	AZ	
DWC-531T-25						12.000	6.903	5.097	270.0	AXC	
DWC-531T-27						14.000	7.965	6.035	229.0	AXE	
DWC-531T-29						16.000	9.027	6.973	198.0	AXI	
DWC-562T-19	3.906	4.000	2.656	0.562	1587.000	6.000	3.934	2.066	767.0	AX	
DWC-562T-20						7.000	4.637	2.364	613.6	AZ	
DWC-562T-21						8.000	5.058	2.942	548.0	AXB	
DWC-562T-22						9.000	5.729	3.271	468.0	AXC	
DWC-562T-23						10.000	6.252	3.748	420.0	AXD	
DWC-562T-25						12.000	7.376	4.624	345.0	AXH	
DWC-562T-27						14.000	8.570	5.430	289.0	AXJ	
DWC-562T-29						16.000	9.695	6.305	251.0	AXL	
DWC-593T-19	3.906	4.000	2.594	0.593	1836.000	6.000	4.151	1.849	978.0	AZ	
DWC-593T-20						7.000	4.892	2.108	782.1	AXB	
DWC-593T-21						8.000	5.337	2.663	699.0	AXC	
DWC-593T-22						9.000	6.001	2.999	602.0	AXE	
DWC-593T-23						10.000	6.597	3.403	536.0	AXF	

Note: Wire Dia. up to .098" is Music Wire (MW); .105" and over is Oil Tempered Wire (OT). For prices from 1 to 100 see Price Index. Please inquire if you need a size not listed above.

STOCK COMPRESSION SPRINGS

Music Wire/Oil Tempered
(See Below)

Ends Squared and Ground Ends to
be Square Within 3 Degrees of Axis

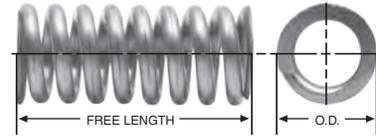

COMPRESSION SPRINGS

DIAMOND WIRE SPRING STOCK NO.	OUTSIDE DIAMETER	TO WORK IN HOLE DIA.	TO WORK OVER ROD DIA.	WIRE DIA.	APPROX. LOAD AT SOLID HT.	FREE LENGTH	SOLID HT.	TOTAL DEFLECTION	SPRING RATE	PRICE GROUP	
	IN.	IN.	IN.	IN.	LB.	IN.	IN.	IN.	LB./IN.	OT/MW	SS
DWC-593T-25	3.906	4.000	2.594	0.593	1836.000	12.000	7.783	4.217	439.0	AXJ	
DWC-593T-27						14.000	9.043	4.957	369.0	AXL	
DWC-593T-29						16.000	10.229	5.771	321.0	AXN	
DWC-625T-19	3.906	4.000	2.531	0.625	2328.000	6.000	4.218	1.782	1307.0	AXB	
DWC-625T-20						7.000	4.922	2.078	1057.1	AXD	
DWC-625T-21						8.000	5.468	2.532	920.0	AXE	
DWC-625T-22						9.000	6.226	2.774	780.0	AXH	
DWC-625T-23						10.000	6.718	3.282	710.0	AXI	
DWC-625T-25						12.000	7.968	4.032	578.0	AXK	
DWC-625T-27						14.000	9.218	4.782	487.0	AXN	
DWC-625T-29						16.000	10.468	5.532	421.0	AXQ	
DWC-375TU-19	4.156	4.250	3.343	0.375	457.000	6.000	2.344	3.656	123.7	AM	
DWC-375TU-20						7.000	2.719	4.281	100.2	AN	
DWC-375TU-21						8.000	2.925	5.075	90.7	AN	
DWC-375TU-22						9.000	3.246	5.754	79.0	AO	
DWC-375TU-23						10.000	3.562	6.438	70.1	AP	
DWC-375TU-25						12.000	4.172	7.828	57.6	AQ	
DWC-375TU-27						14.000	4.781	9.219	48.9	AQ	
DWC-375TU-29						16.000	5.343	10.657	42.9	AS	
DWC-393TU-19	4.156	4.250	3.343	0.393	537.000	6.000	2.456	3.544	151.4	AL	
DWC-393TU-20						7.000	2.898	4.102	119.7	AM	
DWC-393TU-21						8.000	3.095	4.905	109.5	AO	
DWC-393TU-22						9.000	3.448	5.552	95.0	AP	
DWC-393TU-23						10.000	3.733	6.267	85.8	AP	
DWC-393TU-25						12.000	4.372	7.628	70.5	AQ	
DWC-393TU-27						14.000	5.011	8.989	59.8	AR	
DWC-393TU-29						16.000	5.698	10.302	51.5	AT	
DWC-406TU-19	4.156	4.250	3.281	0.406	553.000	6.000	2.639	3.361	164.5	AM	
DWC-406TU-20						7.000	3.045	3.955	134.7	AN	
DWC-406TU-21						8.000	3.350	4.650	118.5	AO	
DWC-406TU-22						9.000	3.703	5.297	104.0	AP	
DWC-406TU-23						10.000	4.060	5.940	92.6	AP	
DWC-406TU-25						12.000	4.770	7.230	76.0	AQ	
DWC-406TU-27						14.000	5.430	8.570	65.1	AS	
DWC-406TU-29						16.000	6.141	9.859	56.4	AT	
DWC-437TU-19	4.156	4.250	3.218	0.437	717.000	6.000	2.840	3.160	226.5	AO	
DWC-437TU-20						7.000	3.332	3.668	181.2	AP	
DWC-437TU-21						8.000	3.605	4.395	163.0	AP	
DWC-437TU-22						9.000	4.011	4.989	142.0	AQ	
DWC-437TU-23						10.000	4.370	5.630	127.4	AQ	
DWC-437TU-25						12.000	5.135	6.865	104.5	AS	
DWC-437TU-27						14.000	5.900	8.100	88.6	AT	
DWC-437TU-29						16.000	6.664	9.336	76.9	AW	
DWC-468TU-19	4.156	4.250	3.156	0.468	914.000	6.000	3.040	2.960	305.5	AT	
DWC-468TU-20						7.000	3.569	3.432	244.4	AU	
DWC-468TU-21						8.000	3.861	4.139	220.0	AU	
DWC-468TU-22						9.000	4.377	4.623	187.0	AW	

Note: Wire Dia. up to .098" is Music Wire (MW); .105" and over is Oil Tempered Wire (OT). For prices from 1 to 100 see Price Index. Please inquire if you need a size not listed above.

STOCK COMPRESSION SPRINGS

Music Wire/Oil Tempered
(See Below)

Ends Squared and Ground Ends to
be Square Within 3 Degrees of Axis

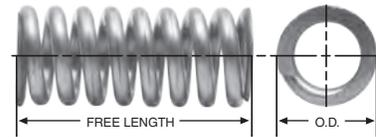

DIAMOND WIRE SPRING STOCK NO.	OUTSIDE DIAMETER	TO WORK IN HOLE DIA.	TO WORK OVER ROD DIA.	WIRE DIA.	APPROX. LOAD AT SOLID HT.	FREE LENGTH	SOLID HT.	TOTAL DEFLECTION	SPRING RATE	PRICE GROUP	
	IN.	IN.	IN.	IN.	LB.	IN.	IN.	IN.	LB./IN.	OT/MW	SS
DWC-468TU-23	4.156	4.250	3.156	0.468	914.000	10.000	4.680	5.320	171.8	AX	
DWC-468TU-25						12.000	5.500	6.500	141.0		
DWC-468TU-27						14.000	6.318	7.682	119.5		
DWC-468TU-29						16.000	7.137	8.863	103.7		
DWC-500TU-19	4.156	4.250	3.000	0.500	1023.000	6.000	3.375	2.625	387.0	AU	
DWC-500TU-20						7.000	3.875	3.125	319.7		
DWC-500TU-21						8.000	4.312	3.688	277.5		
DWC-500TU-22						9.000	4.799	4.201	242.0		
DWC-500TU-23						10.000	5.250	4.750	216.3		
DWC-500TU-25						12.000	6.250	5.750	175.1		
DWC-500TU-27						14.000	7.125	6.875	150.1		
DWC-500TU-29						16.000	8.125	7.875	129.0		
DWC-531TU-19	4.156	4.250	2.968	0.531	1365.000	6.000	3.451	2.549	533.2	AW	
DWC-531TU-20						7.000	4.182	2.818	408.4		
DWC-531TU-21						8.000	4.407	3.593	380.1		
DWC-531TU-22						9.000	4.982	4.018	325.0		
DWC-531TU-23						10.000	5.376	4.624	295.3		
DWC-531TU-25						12.000	6.372	5.628	240.0		
DWC-531TU-27						14.000	7.301	6.699	204.2		
DWC-531TU-29						16.000	8.284	7.716	176.4		
DWC-562TU-19	4.156	4.250	2.968	0.562	1613.000	6.000	3.653	2.347	686.4	AZ	
DWC-562TU-20						7.000	4.426	2.574	525.8		
DWC-562TU-21						8.000	4.707	3.293	484.5		
DWC-562TU-22						9.000	5.307	3.693	415.0		
DWC-562TU-23						10.000	5.732	4.268	376.7		
DWC-562TU-25						12.000	6.744	5.256	309.0		
DWC-562TU-27						14.000	7.798	6.202	260.1		
DWC-562TU-29						16.000	8.851	7.149	224.6		
DWC-593TU-19	4.156	4.250	2.875	0.593	1868.000	6.000	3.954	2.046	873.3	AXB	
DWC-593TU-20						7.000	4.596	2.404	683.5		
DWC-593TU-21						8.000	4.966	3.034	616.4		
DWC-593TU-22						9.000	5.583	3.417	530.0		
DWC-593TU-23						10.000	6.078	3.922	476.3		
DWC-593TU-25						12.000	7.190	4.810	388.1		
DWC-593TU-27						14.000	8.302	5.698	327.5		
DWC-593TU-29						16.000	9.414	6.586	283.2		
DWC-437U-19	4.406	4.500	3.406	0.437	654.000	6.000	2.731	3.269	197.0	AO	
DWC-437U-20						7.000	3.168	3.832	159.7		
DWC-437U-21						8.000	3.441	4.559	143.0		
DWC-437U-22						9.000	3.759	5.241	127.0		
DWC-437U-23						10.000	4.151	5.849	112.0		
DWC-437U-25						12.000	4.807	7.193	93.0		
DWC-437U-27						14.000	5.572	8.428	78.0		
DWC-437U-29						16.000	6.336	9.664	67.0		
DWC-468U-19	4.406	4.500	3.343	0.468	808.000	6.000	2.925	3.075	266.0	AT	
DWC-468U-20						7.000	3.393	3.607	215.1		
DWC-468U-21						8.000	3.744	4.256	188.0		

Note: Wire Dia. up to .098" is Music Wire (MW); .105" and over is Oil Tempered Wire (OT). For prices from 1 to 100 see Price Index. Please inquire if you need a size not listed above.

STOCK COMPRESSION SPRINGS

Music Wire/Oil Tempered
(See Below)

Ends Squared and Ground Ends to
be Square Within 3 Degrees of Axis

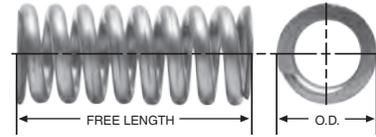

COMPRESSION SPRINGS

DIAMOND WIRE SPRING STOCK NO.	OUTSIDE DIAMETER	TO WORK IN HOLE DIA.	TO WORK OVER ROD DIA.	WIRE DIA.	APPROX. LOAD AT SOLID HT.	FREE LENGTH	SOLID HT.	TOTAL DEFLECTION	SPRING RATE	PRICE GROUP	
	IN.	IN.	IN.	IN.	LB.	IN.	IN.	IN.	LB./IN.	OT/MW	SS
DWC-468U-22	4.406	4.500	3.343	0.468	808.000	9.000	4.100	4.900	167.0	AX	
DWC-468U-23						10.000	4.563	5.437	146.0	AX	
DWC-468U-25						12.000	5.265	6.735	122.0	AZ	
DWC-468U-27						14.000	6.084	7.916	103.0	AXB	
DWC-468U-29						16.000	6.903	9.097	89.0	AXD	
DWC-500U-19	4.406	4.500	3.281	0.500	1007.000	6.000	3.125	2.875	355.0	AU	
DWC-500U-20						7.000	3.688	3.313	280.5	AX	
DWC-500U-21						8.000	4.000	4.000	251.0	AX	
DWC-500U-22						9.000	4.426	4.574	220.0	AZ	
DWC-500U-23						10.000	4.875	5.125	195.0	AXA	
DWC-500U-25						12.000	5.750	6.250	159.0	AXC	
DWC-500U-27						14.000	6.562	7.438	136.0	AXE	
DWC-500U-29						16.000	7.375	8.625	118.0	AXH	
DWC-531U-19	4.406	4.500	3.218	0.531	1228.000	6.000	3.319	2.681	462.0	AX	
DWC-531U-20						7.000	3.983	3.018	357.1	AZ	
DWC-531U-21						8.000	4.248	3.752	327.0	AXA	
DWC-531U-22						9.000	4.747	4.253	283.0	AXB	
DWC-531U-23						10.000	5.177	4.823	253.0	AXC	
DWC-531U-25						12.000	6.040	5.960	210.0	AXE	
DWC-531U-27						14.000	7.036	6.964	175.0	AXI	
DWC-531U-29						16.000	7.965	8.035	151.0	AXK	
DWC-562U-19	4.406	4.500	3.156	0.562	1472.000	6.000	3.512	2.488	594.0	AZ	
DWC-562U-20						7.000	4.215	2.785	459.0	AXB	
DWC-562U-21						8.000	4.496	3.504	421.0	AXC	
DWC-562U-22						9.000	5.033	3.967	363.0	AXD	
DWC-562U-23						10.000	5.480	4.520	326.0	AXE	
DWC-562U-25						12.000	6.463	5.537	266.0	AXI	
DWC-562U-27						14.000	7.446	6.554	224.0	AXK	
DWC-562U-29						16.000	8.430	7.570	194.0	AXM	
DWC-593U-19	4.406	4.500	3.094	0.593	1745.000	6.000	3.706	2.294	754.0	AXB	
DWC-593U-20						7.000	4.299	2.701	610.8	AXC	
DWC-593U-21						8.000	4.744	3.256	534.0	AXD	
DWC-593U-22						9.000	5.320	3.680	460.0	AXG	
DWC-593U-23						10.000	5.782	4.218	414.0	AXH	
DWC-593U-25						12.000	6.820	5.180	338.0	AXK	
DWC-593U-27						14.000	7.875	6.125	285.0	AXM	
DWC-593U-29						16.000	8.895	7.105	246.0	AXO	
DWC-625U-19	4.406	4.500	3.032	0.625	2000.000	6.000	3.906	2.094	955.0	AXF	
DWC-625U-20						7.000	4.531	2.469	772.9	AXG	
DWC-625U-21						8.000	5.000	3.000	676.0	AXJ	
DWC-625U-22						9.000	5.608	3.392	582.0	AXK	
DWC-625U-23						10.000	6.094	3.906	524.0	AXL	
DWC-625U-25						12.000	7.266	4.734	422.0	AXO	
DWC-625U-27						14.000	8.437	5.563	353.0	AXR	
DWC-625U-29						16.000	9.531	6.469	306.0	AXS	
DWC-393UV-19	4.687	4.750	3.750	0.393	473.000	6.000	2.161	3.839	123.7	AL	
DWC-393UV-20						7.000	2.505	4.495	99.0	AN	

Note: Wire Dia. up to .098" is Music Wire (MW); .105" and over is Oil Tempered Wire (OT). For prices from 1 to 100 see Price Index. Please inquire if you need a size not listed above.

STOCK COMPRESSION SPRINGS

Music Wire/Oil Tempered
(See Below)

Ends Squared and Ground Ends to
be Square Within 3 Degrees of Axis

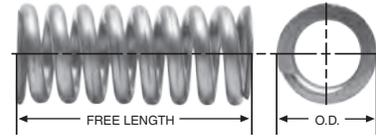

DIAMOND WIRE SPRING STOCK NO.	OUTSIDE DIAMETER	TO WORK IN HOLE DIA.	TO WORK OVER ROD DIA.	WIRE DIA.	APPROX. LOAD AT SOLID HT.	FREE LENGTH	SOLID HT.	TOTAL DEFLECTION	SPRING RATE	PRICE GROUP	
	IN.	IN.	IN.	IN.	LB.	IN.	IN.	IN.	LB./IN.	OT/MW	SS
DWC-393UV-21	4.687	4.750	3.750	0.393	473.000	8.000	2.702	5.298	88.8	AO	
DWC-393UV-22						9.000	2.968	6.032	78.0	AP	
DWC-393UV-23						10.000	3.242	6.758	69.3	AP	
DWC-393UV-25						12.000	3.733	8.267	57.7	AQ	
DWC-393UV-27						14.000	4.274	9.726	48.8	AR	
DWC-393UV-29						16.000	4.814	11.186	42.3	AS	
DWC-406UV-19	4.687	4.750	3.750	0.406	515.000	6.000	2.284	3.716	137.3	AM	
DWC-406UV-20						7.000	2.639	4.361	110.6	AN	
DWC-406UV-21						8.000	2.842	5.158	99.6	AO	
DWC-406UV-22						9.000	3.109	5.891	88.0	AP	
DWC-406UV-23						10.000	3.400	6.600	78.1	AP	
DWC-406UV-25						12.000	3.958	8.042	64.2	AQ	
DWC-406UV-27						14.000	4.567	9.433	53.8	AS	
DWC-406UV-29						16.000	5.075	10.925	47.4	AT	
DWC-437UV-19	4.687	4.750	3.750	0.437	625.000	6.000	2.513	3.487	182.1	AO	
DWC-437UV-20						7.000	2.950	4.050	143.8	AP	
DWC-437UV-21						8.000	3.168	4.832	130.1	AP	
DWC-437UV-22						9.000	3.492	5.508	114.0	AQ	
DWC-437UV-23						10.000	3.823	6.177	101.2	AQ	
DWC-437UV-25						12.000	4.479	7.521	82.8	AS	
DWC-437UV-27						14.000	5.135	8.865	70.0	AT	
DWC-437UV-29						16.000	5.790	10.210	60.7	AW	
DWC-468UV-19	4.687	4.750	3.625	0.468	804.000	6.000	2.691	3.309	244.8	AT	
DWC-468UV-20						7.000	3.159	3.841	193.3	AU	
DWC-468UV-21						8.000	3.393	4.607	174.9	AU	
DWC-468UV-22						9.000	3.820	5.180	149.0	AX	
DWC-468UV-23						10.000	4.095	5.905	136.0	AX	
DWC-468UV-25						12.000	4.797	7.203	111.3	AZ	
DWC-468UV-27						14.000	5.500	8.500	94.2	AXB	
DWC-468UV-29						16.000	6.201	9.799	81.6	AXD	
DWC-500UV-19	4.687	4.750	3.625	0.500	1020.000	6.000	2.875	3.125	326.4	AU	
DWC-500UV-20						7.000	3.375	3.625	257.7	AU	
DWC-500UV-21						8.000	3.625	4.375	233.1	AW	
DWC-500UV-22						9.000	4.221	4.779	190.0	AX	
DWC-500UV-23						10.000	4.375	5.625	181.3	AZ	
DWC-500UV-25						12.000	5.125	6.875	148.4	AXC	
DWC-500UV-27						14.000	5.875	8.125	125.5	AXD	
DWC-500UV-29						16.000	6.625	9.375	108.8	AXG	
DWC-531UV-19	4.687	4.750	3.500	0.531	1118.000	6.000	3.086	2.914	398.0	AX	
DWC-531UV-20						7.000	3.651	3.349	326.6	AZ	
DWC-531UV-21						8.000	4.049	3.951	283.0	AXA	
DWC-531UV-22						9.000	4.499	4.501	246.0	AXB	
DWC-531UV-23						10.000	4.912	5.088	219.6	AXC	
DWC-531UV-25						12.000	5.775	6.225	179.4	AXE	
DWC-531UV-27						14.000	6.637	7.363	151.6	AXI	
DWC-531UV-29						16.000	7.500	8.500	131.3	AXK	

Note: Wire Dia. up to .098" is Music Wire (MW); .105" and over is Oil Tempered Wire (OT). For prices from 1 to 100 see Price Index. Please inquire if you need a size not listed above.

STOCK COMPRESSION SPRINGS

Music Wire/Oil Tempered
(See Below)

Ends Squared and Ground Ends to
be Square Within 3 Degrees of Axis

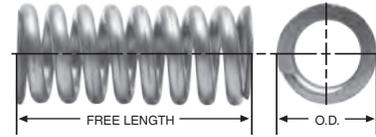

COMPRESSION SPRINGS

DIAMOND WIRE SPRING STOCK NO.	OUTSIDE DIAMETER	TO WORK IN HOLE DIA.	TO WORK OVER ROD DIA.	WIRE DIA.	APPROX. LOAD AT SOLID HT.	FREE LENGTH	SOLID HT.	TOTAL DEFLECTION	SPRING RATE	PRICE GROUP	
	IN.	IN.	IN.	IN.	LB.	IN.	IN.	IN.	LB./IN.	OT/MW	SS
DWC-562UV-19	4.687	4.750	3.500	0.562	1353.000	6.000	3.372	2.628	510.7	AXA	
DWC-562UV-20						7.000	3.934	3.066	408.6	AXC	
DWC-562UV-21						8.000	4.285	3.715	363.2	AXE	
DWC-562UV-22						9.000	4.769	4.231	315.0	AXF	
DWC-562UV-23						10.000	5.198	4.802	281.8	AXF	
DWC-562UV-25						12.000	6.112	5.888	230.2	AXJ	
DWC-562UV-27						14.000	7.025	6.975	194.6	AXK	
DWC-562UV-29						16.000	7.938	8.062	168.5	AXM	
DWC-593UV-19	4.687	4.750	3.375	0.593	1576.000	6.000	3.558	2.442	647.6	AXB	
DWC-593UV-20						7.000	4.151	2.849	518.1	AXC	
DWC-593UV-21						8.000	4.521	3.479	460.5	AXD	
DWC-593UV-22						9.000	5.026	3.974	400.0	AXF	
DWC-593UV-23						10.000	5.559	4.441	351.2	AXH	
DWC-593UV-25						12.000	6.523	5.477	287.8	AXK	
DWC-593UV-27						14.000	7.487	6.513	243.8	AXM	
DWC-593UV-29						16.000	8.524	7.476	209.3	AXP	
DWC-625UV-19	4.687	4.750	3.375	0.625	1837.000	6.000	3.750	2.250	818.1	AXG	
DWC-625UV-20						7.000	4.375	2.625	654.5	AXH	
DWC-625UV-21						8.000	4.912	3.088	574.2	AXK	
DWC-625UV-22						9.000	5.325	3.675	502.0	AXL	
DWC-625UV-23						10.000	5.859	4.141	443.7	AXM	
DWC-625UV-25						12.000	6.906	5.094	361.6	AXO	
DWC-625UV-27						14.000	7.968	6.032	304.4	AXR	
DWC-625UV-29						16.000	9.032	6.968	262.9	AXS	
DWC-468V-19	4.906	5.000	3.843	0.468	690.000	6.000	2.691	3.309	210.0	AT	
DWC-468V-20						7.000	3.276	3.724	183.7	AU	
DWC-468V-21						8.000	3.393	4.607	150.0	AU	
DWC-468V-22						9.000	3.651	5.349	136.0	AW	
DWC-468V-23						10.000	4.095	5.905	117.0	AX	
DWC-468V-25						12.000	4.797	7.203	96.0	AXA	
DWC-468V-27						14.000	5.500	8.500	81.0	AXC	
DWC-468V-29						16.000	6.201	9.799	70.0	AXE	
DWC-500V-19	4.906	5.000	3.781	0.500	875.000	6.000	2.875	3.125	280.0	AU	
DWC-500V-20						7.000	3.563	3.438	238.8	AX	
DWC-500V-21						8.000	3.625	4.375	200.0	AX	
DWC-500V-22						9.000	4.018	4.982	174.0	AXA	
DWC-500V-23						10.000	4.375	5.625	156.0	AXA	
DWC-500V-25						12.000	5.125	6.875	127.0	AXD	
DWC-500V-27						14.000	5.875	8.125	108.0	AXE	
DWC-500V-29						16.000	6.625	9.375	93.0	AXH	
DWC-531V-19	4.906	5.000	3.718	0.531	1081.000	6.000	3.050	2.950	364.0	AX	
DWC-531V-20						7.000	3.783	3.217	310.6	AXA	
DWC-531V-21						8.000	3.850	4.150	260.0	AXA	
DWC-531V-22						9.000	4.213	4.787	230.0	AXB	
DWC-531V-23						10.000	4.646	5.354	202.0	AXC	
DWC-531V-25						12.000	5.143	6.857	165.0	AXE	

Note: Wire Dia. up to .098" is Music Wire (MW); .105" and over is Oil Tempered Wire (OT). For prices from 1 to 100 see Price Index. Please inquire if you need a size not listed above.

STOCK COMPRESSION SPRINGS

Music Wire/Oil Tempered
(See Below)

Ends Squared and Ground Ends to
be Square Within 3 Degrees of Axis

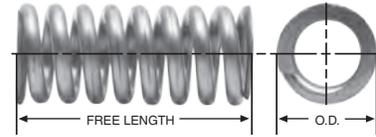

DIAMOND WIRE SPRING STOCK NO.	OUTSIDE DIAMETER	TO WORK IN HOLE DIA.	TO WORK OVER ROD DIA.	WIRE DIA.	APPROX. LOAD AT SOLID HT.	FREE LENGTH	SOLID HT.	TOTAL DEFLECTION	SPRING RATE	PRICE GROUP	
	IN.	IN.	IN.	IN.	LB.	IN.	IN.	IN.	LB./IN.	OT/MW	SS
DWC-531V-27	4.906	5.000	3.718	0.531	1081.000	14.000	6.239	7.761	140.0	AXI	
DWC-531V-29						16.000	7.036	8.964	121.0	AXK	
DWC-562V-19	4.906	5.000	3.656	0.562	1273.000	6.000	3.232	2.768	466.0	AXA	
DWC-562V-20						7.000	4.004	2.996	398.6	AXC	
DWC-562V-21						8.000	4.075	3.925	333.0	AXE	
DWC-562V-22						9.000	4.550	4.450	287.0	AXF	
DWC-562V-23						10.000	5.058	4.942	250.0	AXF	
DWC-562V-25						12.000	5.901	6.099	206.0	AXJ	
DWC-562V-27						14.000	6.744	7.256	175.0	AXK	
DWC-562V-29						16.000	7.587	8.413	152.0	AXM	
DWC-593V-19	4.906	5.000	3.593	0.593	1554.000	6.000	3.410	2.590	591.0	AXB	
DWC-593V-20						7.000	4.151	2.849	518.1	AXC	
DWC-593V-21						8.000	4.299	3.701	422.0	AXD	
DWC-593V-22						9.000	4.846	4.154	359.0	AXF	
DWC-593V-23						10.000	5.189	4.811	328.0	AXH	
DWC-593V-25						12.000	6.078	5.922	268.0	AXK	
DWC-593V-27						14.000	7.116	6.884	222.0	AXM	
DWC-593V-29						16.000	8.006	7.994	193.0	AXP	
DWC-625V-19	4.906	5.000	3.531	0.625	1764.000	6.000	3.594	2.406	746.0	AXG	
DWC-625V-20						7.000	4.453	2.547	638.6	AXI	
DWC-625V-21						8.000	4.609	3.391	520.0	AXK	
DWC-625V-22						9.000	5.133	3.867	450.0	AXL	
DWC-625V-23						10.000	5.625	4.375	399.0	AXM	
DWC-625V-25						12.000	6.563	5.437	329.0	AXO	
DWC-625V-27						14.000	7.656	6.344	273.0	AXR	
DWC-625V-29						16.000	8.594	7.406	238.0	AXS	

COMPRESSION SPRINGS

Note: Wire Dia. up to .098" is Music Wire (MW); .105" and over is Oil Tempered Wire (OT). For prices from 1 to 100 see Price Index. Please inquire if you need a size not listed above.

STOCK EXTENSION SPRINGS

Introduction

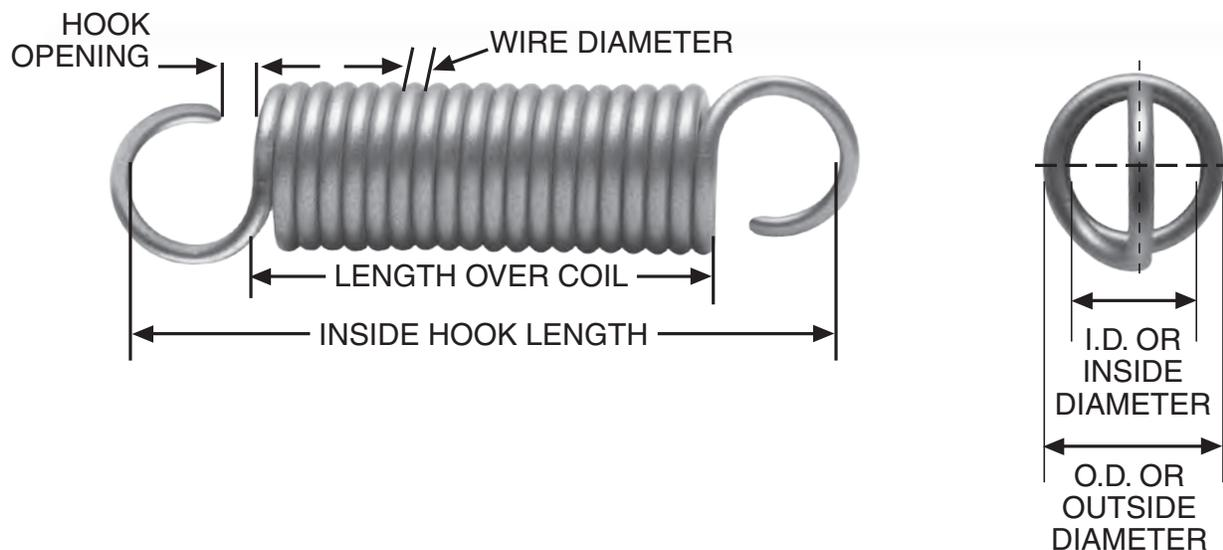

General Information

Blunt end springs are carried in stock in various lengths. When ordered they are cut to length and looped according to your specifications. Please refer to the sketch and order by stating:

- Part number
- Standard machine hooks
- Length inside hooks
- Length over coils

Inside hook length is calculated by using the formula:
 Length over coils + 2 times I.D. of spring.

Design Information

The figures stated on the adjacent page are based on a spring being 1" length over coils. The maximum load a spring can withstand and its initial tension remain fairly constant for any given length; however, the rate per inch and maximum extension varies with actual length.

P/N DWE-062G Is Used In The Following Examples:

A. To Find Rate (R') for a spring other than 1" length over coils, divide the given rate by desired length over coils, use the formula $R' = \text{Given } R / \text{L.O.C.}$
 Example: If one desires a length over coils of 4" on PIN DWE-062G, then 16# given rate / 4" length = 4# rate. This spring will still hold approximately 3.3# initial tension and a total load of 17#.

B. To Find Load at Any Given Working Length one would multiply the rate x deflection plus initial tension, use the formula $P = (R' \times F) + \text{I.T.}$ Example: If PIN DWE-062G is extended from 4" length to 4.750" then to calculate the load at this deflection. (4# rate x .750" deflection) + 3.3 I.T. = 6.3# load.

C. To Find Maximum Extension one would subtract initial tension from maximum load and divide by rate Use the formula $\text{Max Ext} = (\text{Max Load} - \text{I.T.}) / R'$
 Example: (17# max load - 3.3# I.T.) / 4# rate = 3.43" total extension or deflection.

L.O.C. = Length Over Coil
 F = Deflection
 I.T. = Initial Tension
 R = Rate (#) per Inch

We are equipped to manufacture extension springs up to .625" diameter wire. Please call and discuss your requirements.

STOCK EXTENSION SPRINGS

Cut to Length and Looped to Order

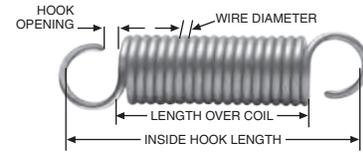

DIAMOND SPRING STOCK NO.	OUTSIDE DIA.	WIRE DIA.	*SAFE MAX. LOAD	SAFE MAX. EXT.	APPROX. INITIAL TENSION	(RATE) LB. PER IN. EXT.	STRESS MAX. LOAD	PRICE CODE
	IN.	IN.	IN.	IN.	LBS.	LB./IN.	LBS./THOUS.	
DWE-012A	0.125	0.012	0.6	1.9	0.07	0.27	100	DEB
DWE-016A		0.016	1.3	0.9	0.2	1.2	93	DEA
DWE-023A		0.023	4.2	0.35	0.9	9	90	DEA
DWE-012AA	0.156	0.012	0.47	3.5	0.01	0.12	100	DEB
DWE-016AA		0.016	1.1	1.7	0.15	0.55	93	DEA
DWE-023AA		0.023	3.2	0.7	0.5	3.9	90	DEA
DWE-016B	0.187	0.016	0.87	2.5	0.1	0.3	93	DEA
DWE-023B		0.023	2.6	1	0.4	2.2	90	DEB
DWE-031B		0.031	6.5	0.45	1.5	10.7	88	DEB
DWE-016BB	0.218	0.016	0.75	4	0.01	0.18	93	DEA
DWE-023BB		0.023	2.3	1.6	0.32	1.2	90	DEB
DWE-031BB		0.031	5.5	0.7	1	6.5	88	DEC
DWE-023C	0.25	0.023	1.8	1.9	0.26	0.8	90	DEB
DWE-031C		0.031	4.7	1	0.75	3.8	88	DEC
DWE-047C		0.047	16	0.3	3.5	40	83	DEC
DWE-023D	0.312	0.023	1.5	3.5	0.16	0.38	90	DEC
DWE-031D		0.031	3.6	1.6	0.55	1.9	88	DEC
DWE-047D		0.047	12.5	0.9	2.2	10.8	83	DED
DWE-031E	0.375	0.031	2.9	2.5	0.37	1	88	DEC
DWE-047E		0.047	10.5	0.9	1.7	9.5	83	DED
DWE-062E		0.062	23	0.39	5.3	45	79	DED
DWE-031F	0.437	0.031	2.5	3.5	0.26	0.63	88	DED
DWE-047F		0.047	8.5	1.2	1.4	5.7	83	DED
DWE-062F		0.062	20	0.6	4.3	26	79	DEE
DWE-047G	0.5	0.047	7.3	1.6	1.1	3.7	83	DEE
DWE-062G		0.062	17	0.8	3.3	16	79	DEE
DWE-078G		0.078	34	0.45	8	57	77	DEF
DWE-094G		0.094	57	0.25	16	160	74	DEF
DWE-047H	0.625	0.047	6	3	0.7	1.7	83	DEE
DWE-062H		0.062	13.3	1.4	2.1	7.6	79	DEF
DWE-078H		0.078	27	0.9	5.2	23	77	DEG
DWE-094H		0.094	45	0.4	11	73	74	DEH
DWE-062I	0.75	0.062	10.5	2.2	1.5	4.1	79	DEG
DWE-078I		0.072	22	1.3	3.5	14	77	DEH
DWE-094I		0.094	36	0.7	8	38	74	DEK
DWE-125I		0.125	85	0.3	22	180	69	DEL
DWE-062J	0.875	0.062	9.2	3.3	1.1	2.4	79	DEH
DWE-078J		0.078	18	1.7	2.6	8.7	77	DEJ
DWE-094J		0.094	31	1	6	25	74	DEK
DWE-125J		0.125	72	0.5	17	107	69	DEL
DWE-078K	1	0.078	16	2.5	2	5.5	77	DEJ
DWE-094K		0.094	26	1.5	4.5	13.7	74	DEL
DWE-125K		0.125	65	0.75	14	68	69	DEM
DWE-187K		0.187	200	0.23	60	600	63	DEN
DWE-094M	1.25	0.094	21	2.6	2.8	6.8	74	DEM
DWE-125M		0.125	47	1.2	9	31	69	DEN
DWE-187M		0.187	148	0.3	40	290	63	DEO

*SAFE MAX LOAD INCLUDES INITIAL TENSION.

Note: Wire Dia. up to .098" is Music Wire (MW); .105" and over is Oil Tempered Wire (OT).
For prices from 1 to 100 see Price Index. Please inquire if you need a size not listed above.

STOCK EXTENSION SPRINGS

Cut to Length and Looped to Order

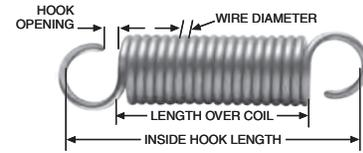

DIAMOND SPRING STOCK NO.	OUTSIDE DIA.	WIRE DIA.	*SAFE MAX. LOAD	SAFE MAX. EXT.	APPROX. INITIAL TENSION	(RATE) LB. PER IN. EXT.	STRESS MAX. LOAD	PRICE CODE
	IN.	IN.	IN.	IN.	LBS.	LB./IN.	LBS./THOUS.	
DWE-125N	1.5	0.125	39	1.9	6	17	69	DEN
DWE-187N		0.187	122	0.6	33	150	63	DEP
DWE-250N		0.25	290	0.24	90	720	60	DES
DWE-187O	1.75	0.187	118	1.35	30	88	63	DER
DWE-250O		0.25	270	0.45	80	416	60	DES
DWE-312O		0.312	560	0.26	200	1400	68	DES
DWE-187P	2	0.187	90	1.3	20	54	63	DES
DWE-250P		0.25	210	0.6	55	260	60	DES
DWE-312P		0.312	435	0.31	160	871	61	DET
DWE-250Q	2.5	0.25	170	1.06	40	123	60	DET
DWE-312Q		0.312	350	0.63	100	400	64	DEU
DWE-375Q		0.375	640	0.4	200	1075	66	DEW
DWE-312R	3	0.312	270	0.93	70	215	61	DEW
DWE-375R		0.375	500	0.63	140	570	63	DEX

EXTENSION SPRINGS

*SAFE MAX LOAD INCLUDES INITIAL TENSION.

Note: Wire Dia. up to .098" is Music Wire (MW); .105" and over is Oil Tempered Wire (OT).
For prices from 1 to 100 see Price Index. Please inquire if you need a size not listed above.

**STOCK EXTENSION
SPRINGS**
Music Wire or Stainless
Loops in Random Position

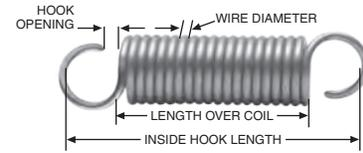

DIAMOND SPRING STOCK NO.	OUTSIDE DIA.	WIRE DIA.	INSIDE HOOK LENGTH	SAFE MAX. LOAD	SAFE MAX. EXTENSION	~INITIAL TENSION	RATE - LB / IN. EXTENSION	PRICE CODE					
	IN.	IN.	IN.	LBS.	IN.	LBS.	LB. / IN.	MW/OT	S S				
DWX-014A-4	0.125	0.014	1/2	1.1	0.490	0.12	2.00	E	F				
DWX-014A-5			5/8		0.700		1.40	E	F				
DWX-014A-6			3/4		0.907		1.08	D	E				
DWX-014A-7			7/8		1.130		0.88	D	E				
DWX-014A-8			1		1.306		0.75	D	E				
DWX-014A-8.5			1 1/8		1.524		0.64	D	E				
DWX-014A-9			1 1/4		1.734		0.56	D	E				
DWX-014A-9.5			1 3/8		1.944		0.50	E	F				
DWX-014A-10			1 1/2		2.150		0.45	E	F				
DWX-016A-4			0.125		0.016		1/2	1.6	0.341	0.2	4.10	E	F
DWX-016A-5	5/8	0.490		2.86		E	F						
DWX-016A-6	3/4	0.667		2.10		D	E						
DWX-016A-7	7/8	0.800		1.75		D	E						
DWX-016A-8	1	0.933		1.50		D	E						
DWX-016A-8.5	1 1/8	1.077		1.30		D	E						
DWX-016A-9	1 1/4	1.167		1.20		E	F						
DWX-016A-9.5	1 3/8	1.400		1.00		E	F						
DWX-016A-10	1 1/2	1.556		0.90		E	F						
DWX-016A-11	1 3/4	1.795		0.78		E	F						
DWX-016A-12	2	2.074		0.68		E	F						
DWX-018A-4	0.125	0.018		1/2		2.2	0.250		0.3		7.58	F	H
DWX-018A-5			5/8	0.355	5.35		F	H					
DWX-018A-6			3/4	0.475	4.00		E	F					
DWX-018A-7			7/8	0.576	3.30		E	F					
DWX-018A-8			1	0.655	2.90		E	F					
DWX-018A-8.5			1 1/8	0.760	2.50		E	F					
DWX-018A-9			1 1/4	0.863	2.20		E	F					
DWX-018A-9.5			1 3/8	0.950	2.00		E	F					
DWX-018A-10			1 1/2	1.055	1.80		F	H					
DWX-018A-11			1 3/4	1.267	1.50		F	H					
DWX-018A-12			2	1.462	1.30		F	H					
DWX-018A-12.5			2 1/4	1.681	1.13		F	H					
DWX-020A-4	0.125	0.02	1/2	2.9	0.187	0.4	13.38	E	F				
DWX-020A-5			5/8		0.265		9.42	E	F				
DWX-020A-6			3/4		0.333		7.50	D	E				
DWX-020A-7			7/8		0.417		6.00	D	E				
DWX-020A-8			1		0.490		5.10	D	E				
DWX-020A-8.5			1 1/8		0.568		4.40	D	E				
DWX-020A-9			1 1/4		0.641		3.90	D	E				
DWX-020A-9.5			1 3/8		0.714		3.50	D	E				
DWX-020A-10			1 1/2		0.781		3.20	D	E				
DWX-020A-11			1 3/4		0.926		2.70	E	F				
DWX-020A-12			2		1.087		2.30	E	F				
DWX-020A-12.5			2 1/4		1.250		2.00	E	F				
DWX-022A-5			0.125		0.022		5/8	3.9	0.214	0.45	16.10	E	F
DWX-022A-6							3/4		0.278		12.40	D	E
DWX-022A-7	7/8	0.338		10.20		D	E						
DWX-022A-8	1	0.397		8.70		D	E						

EXTENSION SPRINGS

Note: Wire Dia. up to .098" is Music Wire (MW); .105" and over is Oil Tempered Wire (OT). Above rates and loads are multiplied by .833 when using stainless. For prices from 1 to 100 see Price Index. Please inquire if you need a size not listed above.

STOCK EXTENSION SPRINGS

Music Wire or Stainless

Loops in Random Position

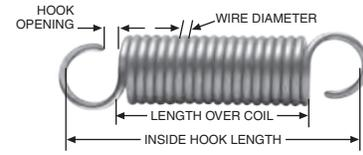

EXTENSION SPRINGS

DIAMOND SPRING STOCK NO.	OUTSIDE DIA.	WIRE DIA.	INSIDE HOOK LENGTH	SAFE MAX. LOAD	SAFE MAX. EXTENSION	~INITIAL TENSION	RATE - LB / IN. EXTENSION	PRICE CODE	
	IN.	IN.	IN.	LBS.	IN.	LBS.	LB. / IN.	MW/OT	S S
DWX-022A-8.5	0.125	0.022	1 1/8	3.9	0.460	0.45	7.50	D	E
DWX-022A-9			1 1/4		0.523		6.60	E	F
DWX-022A-9.5			1 3/8		0.575		6.00	E	F
DWX-022A-10			1 1/2		0.639		5.40	E	F
DWX-022A-11			1 3/4		0.767		4.50	E	F
DWX-022A-12			2		0.885		3.90	E	F
DWX-022A-12.5			2 1/4		1.009		3.42	E	F
DWX-022A-13			2 1/2		1.131		3.05	E	F
DWX-014B-5	0.188	0.014	5/8	0.8	1.434	0.04	0.530	D	E
DWX-014B-7			7/8		2.714		0.280	C	D
DWX-014B-8			1		0.330		2.300	C	D
DWX-014B-8.5			1 1/8		4.000		0.190	C	D
DWX-014B-9			1 1/4		4.471		0.170	C	D
DWX-014B-9.5			1 3/8		5.067		0.150	C	D
DWX-014B-10			1 1/2		5.846		0.130	C	D
DWX-014B-10.5			1 5/8		6.333		0.120	D	E
DWX-014B-11			1 3/4		6.909		0.110	D	E
DWX-014B-11.5			1 7/8		7.600		0.100	D	E
DWX-014B-12			2		8.444		0.090	D	E
DWX-014B-12.5			2 1/4		9.500		0.080	E	F
DWX-014B-13			2 1/2		10.857		0.070	E	F
DWX-016B-5	0.188	0.016	5/8	1.2	1.082	0.075	1.040	D	E
DWX-016B-7			7/8		1.974		0.570	C	D
DWX-016B-8			1		2.446		0.460	C	D
DWX-016B-8.5			1 1/8		2.885		0.390	C	D
DWX-016B-9			1 1/4		3.309		0.340	C	D
DWX-016B-9.5			1 3/8		3.750		0.300	C	D
DWX-016B-10			1 1/2		4.327		0.260	C	D
DWX-016B-10.5			1 5/8		4.688		0.240	D	E
DWX-016B-11			1 3/4		5.114		0.220	D	E
DWX-016B-11.5			1 7/8		5.625		0.200	D	E
DWX-016B-12			2		6.250		0.180	D	E
DWX-016B-12.5			2 1/4		7.031		0.160	E	F
DWX-016B-13			2 1/2		8.036		0.140	E	F
DWX-018B-5	0.188	0.018	5/8	1.5	0.716	0.14	1.900	D	E
DWX-018B-7			7/8		1.295		1.050	C	D
DWX-018B-8			1		1.581		0.860	C	D
DWX-018B-8.5			1 1/8		1.863		0.730	C	D
DWX-018B-9			1 1/4		2.159		0.630	C	D
DWX-018B-9.5			1 3/8		2.473		0.550	C	D
DWX-018B-10			1 1/2		2.720		0.500	C	D
DWX-018B-10.5			1 5/8		3.022		0.450	D	E
DWX-018B-11			1 3/4		3.317		0.410	D	E
DWX-018B-11.5			1 7/8		3.579		0.380	D	E
DWX-018B-12			2		3.886		0.350	D	E
DWX-018B-12.5			2 1/4		4.488		0.303	E	F
DWX-018B-13			2 1/2		5.037		0.270	E	F

Note: Wire Dia. up to .098" is Music Wire (MW); .105" and over is Oil Tempered Wire (OT). Above rates and loads are multiplied by .833 when using stainless. For prices from 1 to 100 see Price Index. Please inquire if you need a size not listed above.

STOCK EXTENSION SPRINGS

Music Wire or Stainless

Loops in Random Position

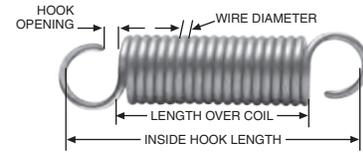

DIAMOND SPRING STOCK NO.	OUTSIDE DIA.	WIRE DIA.	INSIDE HOOK LENGTH	SAFE MAX. LOAD	SAFE MAX. EXTENSION	~INITIAL TENSION	RATE - LB / IN. EXTENSION	PRICE CODE	
	IN.	IN.	IN.	LBS.	IN.	LBS.	LB. / IN.	MW/OT	S S
DWX-020B-5	0.188	0.02	5/8	2	0.539	0.22	3.300	D	E
DWX-020B-7			7/8		0.989		1.800	C	D
DWX-020B-8			1		1.187		1.500	C	D
DWX-020B-8.5			1 1/8		1.369		1.300	C	D
DWX-020B-9			1 1/4		1.618		1.100	C	D
DWX-020B-9.5			1 3/8		1.835		0.970	C	D
DWX-020B-10			1 1/2		2.046		0.870	C	D
DWX-020B-10.5			1 5/8		2.253		0.790	D	E
DWX-020B-11			1 3/4		2.472		0.720	D	E
DWX-020B-11.5			1 7/8		2.697		0.660	D	E
DWX-020B-12			2		2.918		0.610	D	E
DWX-020B-12.5			2 1/4		3.352		0.531	E	F
DWX-020B-13			2 1/2		3.787		0.470	E	F
DWX-022B-4	0.188	0.022	1/2	2.5	0.253	0.3	8.700	D	E
DWX-022B-5			5/8		0.407		5.400	D	E
DWX-022B-6			3/4		0.579		3.800	C	D
DWX-022B-7			7/8		0.688		3.200	C	D
DWX-022B-8			1		0.880		2.500	C	D
DWX-022B-8.5			1 1/8		1.048		2.100	C	D
DWX-022B-9			1 1/4		1.222		1.800	C	D
DWX-022B-9.5			1 3/8		1.375		1.600	C	D
DWX-022B-10			1 1/2		1.571		1.400	D	E
DWX-022B-11			1 3/4		1.833		1.200	D	E
DWX-022B-12			2		2.200		1.000	D	E
DWX-022B-12.5			2 1/4		2.472		0.890	D	E
DWX-022B-13			2 1/2		2.821		0.780	D	E
DWX-024B-5	0.188	0.024	5/8	3.4	0.353	0.4	8.500	D	E
DWX-024B-6			3/4		0.500		6.000	C	D
DWX-024B-7			7/8		0.625		4.800	C	D
DWX-024B-8			1		0.750		4.000	C	D
DWX-024B-8.5			1 1/8		0.893		3.360	C	D
DWX-024B-9			1 1/4		1.031		2.910	C	D
DWX-024B-9.5			1 3/8		1.167		2.570	C	D
DWX-024B-10			1 1/2		1.304		2.300	C	D
DWX-024B-11			1 3/4		1.579		1.900	C	D
DWX-024B-12			2		1.852		1.620	C	D
DWX-024B-12.5			2 1/4		2.113		1.420	C	D
DWX-024B-13			2 1/2		2.381		1.260	C	D
DWX-026B-4			0.188		0.026		1/2	4.3	0.185
DWX-026B-5	5/8	0.301		12.630		D	E		
DWX-026B-6	3/4	0.400		9.500		C	D		
DWX-026B-7	7/8	0.514		7.400		C	D		
DWX-026B-8	1	0.623		6.100		C	D		
DWX-026B-8.5	1 1/8	0.745		5.100		C	D		
DWX-026B-9	1 1/4	0.844		4.500		C	D		
DWX-026B-9.5	1 3/8	0.950		4.000		C	D		
DWX-026B-10	1 1/2	1.086		3.500		C	D		
DWX-026B-11	1 3/4	1.310		2.900		C	D		

EXTENSION SPRINGS

Note: Wire Dia. up to .098" is Music Wire (MW); .105" and over is Oil Tempered Wire (OT). Above rates and loads are multiplied by .833 when using stainless. For prices from 1 to 100 see Price Index. Please inquire if you need a size not listed above.

STOCK EXTENSION SPRINGS

Music Wire or Stainless

Loops in Random Position

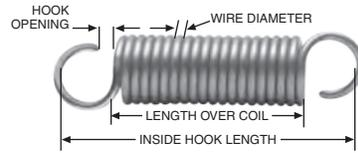

EXTENSION SPRINGS

DIAMOND SPRING STOCK NO.	OUTSIDE DIA.	WIRE DIA.	INSIDE HOOK LENGTH	SAFE MAX. LOAD	SAFE MAX. EXTENSION	~INITIAL TENSION	RATE - LB / IN. EXTENSION	PRICE CODE					
	IN.	IN.	IN.	LBS.	IN.	LBS.	LB. / IN.	MW/OT	S S				
DWX-026B-12	0.188	0.026	2	4.3	1.520	0.5	2.500	C	D				
DWX-026B-12.5			2 1/4		1.727		2.200	C	D				
DWX-026B-13			2 1/2		1.969		1.930	C	D				
DWX-029B-5	0.188	0.029	5/8	5.8	0.225	0.75	22.400	D	E				
DWX-029B-6			3/4		0.301		16.800	C	D				
DWX-029B-7			7/8		0.385		13.100	C	D				
DWX-029B-8			1		0.459		11.000	C	D				
DWX-029B-8.5			1 1/8		0.544		9.280	D	E				
DWX-029B-9			1 1/4		0.624		8.090	D	E				
DWX-029B-9.5			1 3/8		0.704		7.170	D	E				
DWX-029B-10			1 1/2		0.784		6.440	D	E				
DWX-029B-11			1 3/4		0.947		5.330	D	E				
DWX-029B-12			2		1.107		4.560	D	E				
DWX-029B-12.5			2 1/4		1.259		4.010	D	E				
DWX-029B-13			2 1/2		1.427		3.540	D	E				
DWX-031B-4			0.188		0.031		1/2	7	0.117	0.9	52.000	D	E
DWX-031B-5	5/8	0.192		31.720		D	E						
DWX-031B-6	3/4	0.253		24.100		C	D						
DWX-031B-7	7/8	0.321		19.000		C	D						
DWX-031B-8	1	0.386		15.800		C	D						
DWX-031B-8.5	1 1/8	0.452		13.500		C	D						
DWX-031B-9	1 1/4	0.521		11.700		C	D						
DWX-031B-9.5	1 3/8	0.587		10.400		C	D						
DWX-031B-10	1 1/2	0.663		9.200		C	D						
DWX-031B-11	1 3/4	0.792		7.700		C	D						
DWX-031B-12	2	0.924		6.600		C	D						
DWX-031B-12.5	2 1/4	1.070		5.700		D	E						
DWX-031B-13	2 1/2	1.196		5.100		D	E						
DWX-031B-13.5	2 3/4	1.356		4.500		D	E						
DWX-034B-5	0.188	0.034		5/8		9	0.153		0.85		53.300	D	E
DWX-034B-6			3/4	0.204	40.000		C	D					
DWX-034B-7			7/8	0.263	31.000		C	D					
DWX-034B-8			1	0.313	26.000		C	D					
DWX-034B-8.5			1 1/8	0.364	22.400		C	D					
DWX-034B-9			1 1/4	0.422	19.300		C	D					
DWX-034B-9.5			1 3/8	0.474	17.200		C	D					
DWX-034B-10			1 1/2	0.526	15.500		D	E					
DWX-034B-11			1 3/4	0.632	12.900		D	E					
DWX-034B-12			2	0.741	11.000		D	E					
DWX-034B-12.5			2 1/4	0.849	9.600		D	E					
DWX-034B-13			2 1/2	0.959	8.500		D	E					
DWX-034B-13.5			2 3/4	1.072	7.600		D	E					
DWX-018C-5			0.25	0.018	5/8		1.1	0.787		0.1	1.270	D	E
DWX-018C-6					3/4			1.333			0.750	D	E
DWX-018C-7	7/8	1.887			0.530	C		D					
DWX-018C-8	1	2.439			0.410	C		D					
DWX-018C-8.5	1 1/8	3.030			0.330	C		D					
DWX-018C-9	1 1/4	3.571			0.280	D		E					

Note: Wire Dia. up to .098" is Music Wire (MW); .105" and over is Oil Tempered Wire (OT). Above rates and loads are multiplied by .833 when using stainless. For prices from 1 to 100 see Price Index. Please inquire if you need a size not listed above.

STOCK EXTENSION SPRINGS

Music Wire or Stainless

Loops in Random Position

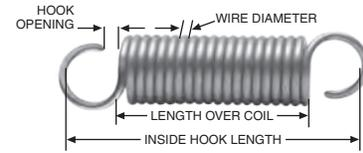

DIAMOND SPRING STOCK NO.	OUTSIDE DIA.	WIRE DIA.	INSIDE HOOK LENGTH	SAFE MAX. LOAD	SAFE MAX. EXTENSION	~INITIAL TENSION	RATE - LB / IN. EXTENSION	PRICE CODE	
	IN.	IN.	IN.	LBS.	IN.	LBS.	LB. / IN.	MW/OT	S S
DWX-018C-9.5	0.25	0.018	1 3/8	1.1	4.167	0.1	0.240	D	E
DWX-018C-10			1 1/2		4.545		0.220	D	E
DWX-018C-11			1 3/4		5.882		0.170	D	E
DWX-018C-12			2		6.667		0.150	D	E
DWX-018C-12.5			2 1/4		7.692		0.130	D	E
DWX-018C-13			2 1/2		9.091		0.110	D	E
DWX-018C-13.5			2 3/4		10.000		0.100	D	E
DWX-022C-5	0.25	0.022	5/8	2.1	0.576	0.2	3.300	D	E
DWX-022C-6			3/4		0.950		2.000	D	E
DWX-022C-7			7/8		1.267		1.500	C	D
DWX-022C-8			1		1.667		1.140	C	D
DWX-022C-8.5			1 1/8		2.021		0.940	C	D
DWX-022C-9			1 1/4		2.375		0.800	D	E
DWX-022C-9.5			1 3/8		2.714		0.700	D	E
DWX-022C-10			1 1/2		3.167		0.600	D	E
DWX-022C-11			1 3/4		3.800		0.500	D	E
DWX-022C-12			2		4.750		0.400	D	E
DWX-022C-12.5			2 1/4		5.278		0.360	D	E
DWX-022C-13			2 1/2		5.938		0.320	D	E
DWX-022C-13.5			2 3/4		6.786		0.280	D	E
DWX-026C-4	0.25	0.026	1/2	3.1	0.133	0.4	20.300	D	E
DWX-026C-5			5/8		0.355		7.600	D	E
DWX-026C-6			3/4		0.563		4.800	C	D
DWX-026C-7			7/8		0.771		3.500	C	D
DWX-026C-8			1		0.964		2.800	C	D
DWX-026C-8.5			1 1/8		1.174		2.300	C	D
DWX-026C-9			1 1/4		1.421		1.900	C	D
DWX-026C-9.5			1 3/8		1.588		1.700	C	D
DWX-026C-10			1 1/2		1.800		1.500	C	D
DWX-026C-11			1 3/4		2.250		1.200	D	E
DWX-026C-12			2		2.700		1.000	D	E
DWX-026C-12.5			2 1/4		3.140		0.860	D	E
DWX-026C-13			2 1/2		3.553		0.760	D	E
DWX-026C-13.5			2 3/4		3.971		0.680	D	E
DWX-026C-14	3	4.500	0.600	D	E				
DWX-029C-5	0.25	0.029	5/8	4.3	0.286	0.55	13.100	D	E
DWX-029C-6			3/4		0.475		7.900	D	E
DWX-029C-7			7/8		0.625		6.000	C	D
DWX-029C-8			1		0.798		4.700	C	D
DWX-029C-8.5			1 1/8		0.962		3.900	C	D
DWX-029C-9			1 1/4		1.103		3.400	C	D
DWX-029C-9.5			1 3/8		1.293		2.900	C	D
DWX-029C-10			1 1/2		1.471		2.550	D	E
DWX-029C-11			1 3/4		1.786		2.100	D	E
DWX-029C-12			2		2.083		1.800	D	E
DWX-029C-12.5			2 1/4		2.344		1.600	D	E
DWX-029C-13			2 1/2		2.737		1.370	D	E

EXTENSION SPRINGS

Note: Wire Dia. up to .098" is Music Wire (MW); .105" and over is Oil Tempered Wire (OT). Above rates and loads are multiplied by .833 when using stainless. For prices from 1 to 100 see Price Index. Please inquire if you need a size not listed above.

STOCK EXTENSION SPRINGS

Music Wire or Stainless

Loops in Random Position

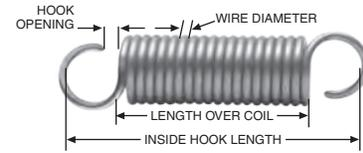

DIAMOND SPRING STOCK NO.	OUTSIDE DIA.	WIRE DIA.	INSIDE HOOK LENGTH	SAFE MAX. LOAD	SAFE MAX. EXTENSION	~INITIAL TENSION	RATE - LB / IN. EXTENSION	PRICE CODE	
	IN.	IN.	IN.	LBS.	IN.	LBS.	LB. / IN.	MW/OT	S S
DWX-029C-13.5	0.25	0.029	2 3/4	4.3	3.074	0.55	1.220	D	E
DWX-029C-14			3		3.409		1.100	D	E
DWX-031C-5	0.25	0.031	5/8	5.2	0.239	0.7	18.840	D	E
DWX-031C-6			3/4		0.375		12.000	D	E
DWX-031C-7			7/8		0.511		8.800	C	D
DWX-031C-8			1		0.652		6.900	C	D
DWX-031C-8.5			1 1/8		0.789		5.700	C	D
DWX-031C-9			1 1/4		0.918		4.900	C	D
DWX-031C-9.5			1 3/8		1.047		4.300	C	D
DWX-031C-10			1 1/2		1.184		3.800	C	D
DWX-031C-11			1 3/4		1.500		3.000	D	E
DWX-031C-12			2		1.731		2.600	D	E
DWX-031C-12.5			2 1/4		2.045		2.200	D	E
DWX-031C-13			2 1/2		2.250		2.000	D	E
DWX-031C-13.5			2 3/4		2.571		1.750	D	E
DWX-031C-14			3		2.866		1.570	D	E
DWX-034C-5	0.25	0.034	5/8	6.8	0.210	0.85	28.400	D	E
DWX-034C-6			3/4		0.334		17.800	D	E
DWX-034C-7			7/8		0.441		13.500	C	D
DWX-034C-8			1		0.551		10.800	C	D
DWX-034C-8.5			1 1/8		0.654		9.100	C	D
DWX-034C-9			1 1/4		0.753		7.900	C	D
DWX-034C-9.5			1 3/8		0.888		6.700	C	D
DWX-034C-10			1 1/2		0.975		6.100	D	E
DWX-034C-11			1 3/4		1.214		4.900	D	E
DWX-034C-12			2		1.417		4.200	D	E
DWX-034C-12.5			2 1/4		1.653		3.600	D	E
DWX-034C-13			2 1/2		1.859		3.200	E	F
DWX-034C-13.5			2 3/4		2.088		2.850	E	F
DWX-034C-14			3		2.288		2.600	E	F
DWX-037C-5	0.25	0.037	5/8	8.5	0.168	1	44.700	D	E
DWX-037C-6			3/4		0.258		29.100	C	D
DWX-037C-8			1		0.424		17.700	C	D
DWX-037C-8.5			1 1/8		0.500		15.000	C	D
DWX-037C-9			1 1/4		0.591		12.700	C	D
DWX-037C-9.5			1 3/8		0.682		11.000	C	D
DWX-037C-10			1 1/2		0.773		9.700	C	D
DWX-037C-11			1 3/4		0.938		8.000	D	E
DWX-037C-12			2		1.119		6.700	D	E
DWX-037C-12.5			2 1/4		1.293		5.800	D	E
DWX-037C-13			2 1/2		1.471		5.100	E	F
DWX-037C-13.5			2 3/4		1.630		4.600	E	F
DWX-037C-14			3		1.829		4.100	E	F
DWX-037C-14.5			3 1/4		2.000		3.750	E	F
DWX-037C-15	3 1/2	2.193	3.420	E	F				
DWX-041C-6	0.25	0.041	3/4	11.7	0.206	1.05	51.600	D	E
DWX-041C-8			1		0.355		30.000	D	E
DWX-041C-8.5			1 1/8		0.426		25.000	D	E

Note: Wire Dia. up to .098" is Music Wire (MW); .105" and over is Oil Tempered Wire (OT). Above rates and loads are multiplied by .833 when using stainless. For prices from 1 to 100 see Price Index. Please inquire if you need a size not listed above.

EXTENSION SPRINGS

STOCK EXTENSION SPRINGS

Music Wire or Stainless

Loops in Random Position

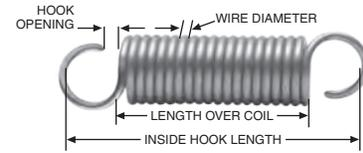

DIAMOND SPRING STOCK NO.	OUTSIDE DIA.	WIRE DIA.	INSIDE HOOK LENGTH	SAFE MAX. LOAD	SAFE MAX. EXTENSION	~INITIAL TENSION	RATE - LB / IN. EXTENSION	PRICE CODE	
	IN.	IN.	IN.	LBS.	IN.	LBS.	LB. / IN.	MW/OT	S S
DWX-041C-9	0.25	0.041	1 1/4	11.7	0.495	1.05	21.500	D	E
DWX-041C-9.5			1 3/8		0.561		19.000	D	E
DWX-041C-10			1 1/2		0.634		16.800	D	E
DWX-041C-11			1 3/4		0.772		13.800	E	F
DWX-041C-12			2		0.910		11.700	E	F
DWX-041C-12.5			2 1/4		1.054		10.100	E	F
DWX-041C-13			2 1/2		1.197		8.900	E	F
DWX-041C-13.5			2 3/4		1.331		8.000	E	F
DWX-041C-14			3		1.469		7.250	E	F
DWX-041C-15			3.5		1.746		6.100	E	F
DWX-030D-8	0.312	0.03	1	4	1.029	0.4	3.500	B	C
DWX-030D-8.5			1 1/8		1.333		2.700	B	C
DWX-030D-9			1 1/4		1.565		2.300	B	C
DWX-030D-9.5			1 3/8		1.895		1.900	B	C
DWX-030D-10			1 1/2		2.118		1.700	B	C
DWX-030D-11			1 3/4		2.769		1.300	C	D
DWX-030D-12			2		3.273		1.100	D	E
DWX-030D-12.5			2 1/4		3.830		0.940	D	E
DWX-030D-13	2 1/2	4.337	0.830	D	E				
DWX-037D-8	0.312	0.037	1	7	0.686	0.83	9.000	B	C
DWX-037D-8.5			1 1/8		0.881		7.000	B	C
DWX-037D-9			1 1/4		1.028		6.000	B	C
DWX-037D-9.5			1 3/8		1.187		5.200	B	C
DWX-037D-10			1 1/2		1.341		4.600	B	C
DWX-037D-11			1 3/4		1.714		3.600	C	D
DWX-037D-12			2		1.990		3.100	D	E
DWX-037D-12.5			2 1/4		2.373		2.600	D	E
DWX-037D-13			2 1/2		2.571		2.400	D	E
DWX-037D-13.5			2 3/4		2.938		2.100	E	F
DWX-037D-14	3	3.247	1.900	E	F				
DWX-043D-8	0.312	0.043	1	10.25	0.399	1.3	22.430	C	D
DWX-043D-8.5			1 1/8		0.498		17.980	C	D
DWX-043D-9			1 1/4		0.597		15.000	C	D
DWX-043D-9.5			1 3/8		0.695		12.870	C	D
DWX-043D-10			1 1/2		0.794		11.270	C	D
DWX-043D-11			1 3/4		0.991		9.030	D	E
DWX-043D-12			2		1.189		7.530	D	E
DWX-043D-12.5			2 1/4		1.385		6.460	E	D
DWX-043D-13			2 1/2		1.584		5.650	G	H
DWX-043D-13.5			2 3/4		1.783		5.020	G	H
DWX-043D-14	3	1.980	4.520	G	H				
DWX-049D-8	0.312	0.049	1	15	0.367	1.8	36.000	C	D
DWX-049D-8.5			1 1/8		0.440		30.000	C	D
DWX-049D-9			1 1/4		0.508		26.000	C	D
DWX-049D-9.5			1 3/8		0.574		23.000	C	D
DWX-049D-10			1 1/2		0.629		21.000	C	D
DWX-049D-11			1 3/4		0.800		16.500	D	E
DWX-049D-12			2		0.943		14.000	D	E

EXTENSION SPRINGS

Note: Wire Dia. up to .098" is Music Wire (MW); .105" and over is Oil Tempered Wire (OT). Above rates and loads are multiplied by .833 when using stainless. For prices from 1 to 100 see Price Index. Please inquire if you need a size not listed above.

STOCK EXTENSION SPRINGS

Music Wire or Stainless

Loops in Random Position

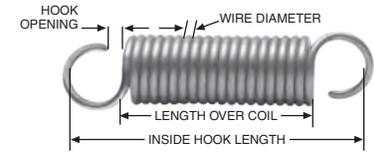

EXTENSION SPRINGS

DIAMOND SPRING STOCK NO.	OUTSIDE DIA.	WIRE DIA.	INSIDE HOOK LENGTH	SAFE MAX. LOAD	SAFE MAX. EXTENSION	~INITIAL TENSION	RATE - LB / IN. EXTENSION	PRICE CODE	
	IN.	IN.	IN.	LBS.	IN.	LBS.	LB. / IN.	MW/OT	S S
DWX-049D-12.5	0.312	0.049	2 1/4	15	1.100	1.8	12.000	E	F
DWX-049D-13			2 1/2		1.200		11.000	G	H
DWX-049D-13.5			2 3/4		1.320		10.000	G	H
DWX-049D-14			3		1.467		9.000	G	H
DWX-055D-8	0.312	0.055	1	21	0.219	3	82.210	D	E
DWX-055D-8.5			1 1/8		0.270		66.780	D	E
DWX-055D-9			1 1/4		0.320		56.220	D	E
DWX-055D-9.5			1 3/8		0.371		48.550	D	E
DWX-055D-10			1 1/2		0.421		42.720	D	E
DWX-055D-11			1 3/4		0.522		34.450	E	F
DWX-055D-12			2		0.624		28.850	E	F
DWX-055D-12.5			2 1/4		0.725		24.830	F	H
DWX-055D-13			2 1/2		0.826		21.790	H	I
DWX-055D-13.5			2 3/4		0.927		19.410	H	I
DWX-055D-14			3		1.029		17.500	H	I
DWX-026E-8	0.375	0.026	1	2.3	1.600	0.22	1.300	B	C
DWX-026E-8.5			1 1/8		2.261		0.920	B	C
DWX-026E-9			1 1/4		2.889		0.720	B	C
DWX-026E-9.5			1 3/8		3.467		0.600	B	C
DWX-026E-10			1 1/2		4.160		0.500	B	C
DWX-026E-11			1 3/4		5.333		0.390	B	C
DWX-031E-7	0.375	0.031	7/8	3.4	0.638	0.3	4.860	C	D
DWX-031E-8			1		1.000		3.100	B	C
DWX-031E-8.5			1 1/8		1.348		2.300	B	C
DWX-031E-9			1 1/4		1.722		1.800	B	C
DWX-031E-9.5			1 3/8		2.067		1.500	B	C
DWX-031E-10			1 1/2		2.385		1.300	B	C
DWX-031E-11			1 3/4		3.236		0.958	B	C
DWX-031E-12			2		3.974		0.780	B	C
DWX-031E-12.5			2 1/4		4.697		0.660	B	C
DWX-031E-13			2 1/2		5.439		0.570	B	C
DWX-031E-13.5			2 3/4		6.151		0.504	C	D
DWX-031E-14	3	6.874	0.451	C	D				
DWX-034E-8	0.375	0.034	1	4.6	0.854	0.5	4.800	B	C
DWX-034E-8.5			1 1/8		1.139		3.600	B	C
DWX-034E-9			1 1/4		1.464		2.800	B	C
DWX-034E-9.5			1 3/8		1.708		2.400	B	C
DWX-034E-10			1 1/2		2.050		2.000	B	C
DWX-034E-11			1 3/4		2.563		1.600	C	D
DWX-034E-12			2		3.154		1.300	D	E
DWX-037E-6	0.375	0.037	3/4	5.8	0.210	0.7	24.300	C	D
DWX-037E-8			1		0.662		7.700	B	C
DWX-037E-8.5			1 1/8		0.911		5.600	B	C
DWX-037E-9			1 1/4		1.159		4.400	B	C
DWX-037E-9.5			1 3/8		1.378		3.700	B	C
DWX-037E-10			1 1/2		1.594		3.200	B	C
DWX-037E-11			1 3/4		2.125		2.400	C	D
DWX-037E-12			2		2.550		2.000	D	E

Note: Wire Dia. up to .098" is Music Wire (MW); .105" and over is Oil Tempered Wire (OT). Above rates and loads are multiplied by .833 when using stainless. For prices from 1 to 100 see Price Index. Please inquire if you need a size not listed above.

STOCK EXTENSION SPRINGS

Music Wire or Stainless

Loops in Random Position

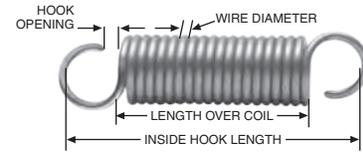

DIAMOND SPRING STOCK NO.	OUTSIDE DIA.	WIRE DIA.	INSIDE HOOK LENGTH	SAFE MAX. LOAD	SAFE MAX. EXTENSION	~INITIAL TENSION	RATE - LB / IN. EXTENSION	PRICE CODE	
	IN.	IN.	IN.	LBS.	IN.	LBS.	LB. / IN.	MW/OT	S S
DWX-037E-12.5	0.375	0.037	2 1/4	5.8	3.000	0.7	1.700	D	E
DWX-037E-13			2 1/2		3.643		1.400	D	E
DWX-037E-13.5			2 3/4		4.048		1.260	D	E
DWX-037E-14			3		4.474		1.140	D	E
DWX-039E-8	0.375	0.039	1	6.8	0.625	0.8	9.600	B	C
DWX-039E-8.5			1 1/8		0.857		7.000	B	C
DWX-039E-9			1 1/4		1.053		5.700	B	C
DWX-039E-9.5			1 3/8		1.250		4.800	B	C
DWX-039E-10			1 1/2		1.463		4.100	B	C
DWX-039E-11			1 3/4		1.875		3.200	C	D
DWX-039E-12			2		2.308		2.600	D	E
DWX-039E-12.5			2 1/4		2.727		2.200	D	E
DWX-039E-13			2 1/2		3.158		1.9	E	F
DWX-039E-13.5			2 3/4		3.550		1.69	E	F
DWX-039E-14	3	3.974	1.51	F	H				
DWX-041E-6	0.375	0.041	3/4	7.8	0.182	0.9	38.000	C	D
DWX-041E-8			1		0.543		12.700	B	C
DWX-041E-8.5			1 1/8		0.726		9.500	B	C
DWX-041E-9			1 1/4		0.908		7.600	B	C
DWX-041E-9.5			1 3/8		1.078		6.400	B	C
DWX-041E-10			1 1/2		1.255		5.500	B	C
DWX-041E-11			1 3/4		1.643		4.200	C	D
DWX-041E-12			2		2.029		3.400	D	E
DWX-041E-12.5			2 1/4		2.379		2.900	D	E
DWX-041E-13			2 1/2		2.760		2.500	E	F
DWX-041E-13.5			2 3/4		3.151		2.190	F	H
DWX-041E-14	3	3.520	1.960	G	H				
DWX-041E-15	3 1/2	4.233	1.630	G	H				
DWX-045E-6	0.375	0.045	3/4	10	0.154	1.2	57.000	C	D
DWX-045E-8			1		0.436		20.200	B	C
DWX-045E-8.5			1 1/8		0.564		15.600	B	C
DWX-045E-9			1 1/4		0.721		12.200	B	C
DWX-045E-9.5			1 3/8		0.871		10.100	B	C
DWX-045E-10			1 1/2		1.000		8.800	B	C
DWX-045E-11			1 3/4		1.173		7.500	C	D
DWX-045E-12			2		1.571		5.600	C	D
DWX-045E-12.5			2 1/4		1.833		4.800	D	E
DWX-045E-13			2 1/2		2.146		4.100	E	F
DWX-045E-13.5			2 3/4		2.444		3.600	E	F
DWX-045E-14			3		2.750		3.200	E	F
DWX-045E-15			3 1/2		3.385		2.600	F	G
DWX-045E-16	4	3.911	2.250	F	G				
DWX-045E-17	4 1/2	4.444	1.980	G	H				
DWX-049E-8	0.375	0.049	1	13	0.383	1.5	30.000	C	D
DWX-049E-8.5			1 1/8		0.485		23.700	C	D
DWX-049E-9			1 1/4		0.605		19.000	C	D
DWX-049E-9.5			1 3/8		0.719		16.000	C	D
DWX-049E-10			1 1/2		0.827		13.900	C	D

EXTENSION SPRINGS

Note: Wire Dia. up to .098" is Music Wire (MW); .105" and over is Oil Tempered Wire (OT). Above rates and loads are multiplied by .833 when using stainless. For prices from 1 to 100 see Price Index. Please inquire if you need a size not listed above.

STOCK EXTENSION SPRINGS
Music Wire or Stainless
Loops in Random Position

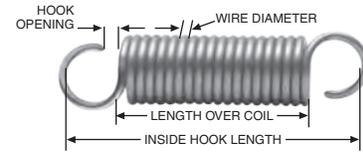

EXTENSION SPRINGS

DIAMOND SPRING STOCK NO.	OUTSIDE DIA.	WIRE DIA.	INSIDE HOOK LENGTH	SAFE MAX. LOAD	SAFE MAX. EXTENSION	~INITIAL TENSION	RATE - LB / IN. EXTENSION	PRICE CODE	
	IN.	IN.	IN.	LBS.	IN.	LBS.	LB. / IN.	MW/OT	S S
DWX-049E-11	0.375	0.049	1 3/4	13	1.065	1.5	10.800	D	E
DWX-049E-12			2		1.278		9.000	D	E
DWX-049E-12.5			2 1/4		1.533		7.500	E	F
DWX-049E-13			2 1/2		1.797		6.400	G	H
DWX-049E-13.5			2 3/4		1.983		5.800	G	H
DWX-049E-14			3		2.212		5.200	G	H
DWX-049E-15			3 1/2		2.738		4.200	G	H
DWX-049E-16			4		3.194		3.600	H	I
DWX-049E-17			4 1/2		3.594		3.200	I	K
DWX-049E-18	5	4.152	2.770	J	N				
DWX-052E-8	0.375	0.052	1	15.5	0.338	1.75	40.700	D	E
DWX-052E-8.5			1 1/8		0.444		31.000	D	E
DWX-052E-9			1 1/4		0.550		25.000	D	E
DWX-052E-9.5			1 3/8		0.634		21.700	D	E
DWX-052E-10			1 1/2		0.739		18.600	D	E
DWX-052E-11			1 3/4		0.948		14.500	D	E
DWX-052E-12			2		1.050		13.100	D	E
DWX-052E-12.5			2 1/4		1.348		10.200	E	F
DWX-052E-13			2 1/2		1.563		8.800	G	H
DWX-052E-13.5	2 3/4	1.763	7.800	G	H				
DWX-052E-14	3	1.964	7.000	G	H				
DWX-055E-8	0.375	0.055	1	17.5	0.278	2	55.800	D	E
DWX-055E-9			1 1/4		0.445		34.800	D	E
DWX-055E-9.5			1 3/8		0.520		29.800	D	E
DWX-055E-10			1 1/2		0.610		25.400	D	E
DWX-055E-11			1 3/4		0.779		19.900	D	E
DWX-055E-12			2		0.945		16.400	E	F
DWX-055E-12.5			2 1/4		1.115		13.900	G	H
DWX-055E-13			2 1/2		1.303		11.900	G	H
DWX-055E-13.5			2 3/4		1.462		10.600	G	H
DWX-055E-14			3		1.632		9.500	G	H
DWX-055E-15			3 1/2		1.962		7.900	G	H
DWX-055E-16			4		2.279		6.800	H	I
DWX-055E-17			4 1/2		2.627		5.900	I	K
DWX-055E-18			5		2.925		5.300	J	N
DWX-055E-18.5	5 1/2	3.312	4.680	K	O				
DWX-055E-19	6	3.664	4.230	L	Q				
DWX-058E-8	0.375	0.058	1	20	0.246	2.5	71.100	E	F
DWX-058E-8.5			1 1/8		0.312		56.100	E	F
DWX-058E-9			1 1/4		0.394		44.400	E	F
DWX-058E-9.5			1 3/8		0.459		38.100	E	F
DWX-058E-10			1 1/2		0.526		33.300	E	F
DWX-058E-11			1 3/4		0.673		26.000	E	F
DWX-058E-12			2		0.803		21.800	E	F
DWX-058E-12.5			2 1/4		0.951		18.400	F	H
DWX-058E-13			2 1/2		1.101		15.900	H	I
DWX-058E-13.5			2 3/4		1.232		14.200	H	I
DWX-058E-14			3		1.378		12.700	I	K

Note: Wire Dia. up to .098" is Music Wire (MW); .105" and over is Oil Tempered Wire (OT). Above rates and loads are multiplied by .833 when using stainless. For prices from 1 to 100 see Price Index. Please inquire if you need a size not listed above.

STOCK EXTENSION SPRINGS

Music Wire or Stainless

Loops in Random Position

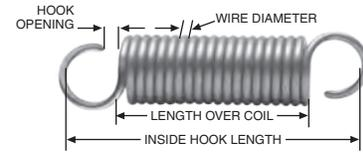

DIAMOND SPRING STOCK NO.	OUTSIDE DIA.	WIRE DIA.	INSIDE HOOK LENGTH	SAFE MAX. LOAD	SAFE MAX. EXTENSION	~INITIAL TENSION	RATE - LB / IN. EXTENSION	PRICE CODE	
	IN.	IN.	IN.	LBS.	IN.	LBS.	LB. / IN.	MW/OT	S S
DWX-037F-8	0.437	0.037	1	5.5	1.303	0.55	3.800	D	E
DWX-037F-8.5			1 1/8		1.650		3.000	D	E
DWX-037F-9			1 1/4		2.063		2.400	D	E
DWX-037F-9.5			1 3/8		2.475		2.000	E	F
DWX-037F-10			1 1/2		2.829		1.750	F	H
DWX-037F-11			1 3/4		3.536		1.400	H	I
DWX-037F-12			2		4.500		1.100	H	I
DWX-037F-12.5			2 1/4		5.103		0.970	I	K
DWX-037F-13			2 1/2		5.824		0.850	I	K
DWX-037F-13.5			2 3/4		6.600		0.750	J	N
DWX-037F-14	3	7.500	0.660	J	N				
DWX-046F-8	0.437	0.046	1	10	0.481	1	18.700	E	F
DWX-046F-8.5			1 1/8		0.682		13.200	E	F
DWX-046F-9			1 1/4		0.923		9.750	E	F
DWX-046F-9.5			1 3/8		1.125		8.000	E	F
DWX-046F-10			1 1/2		1.324		6.800	E	F
DWX-046F-11			1 3/4		1.765		5.100	F	H
DWX-046F-12			2		2.195		4.100	I	K
DWX-046F-12.5			2 1/4		2.647		3.400	I	K
DWX-046F-13			2 1/2		3.103		2.900	I	K
DWX-046F-13.5			2 3/4		3.529		2.550	J	N
DWX-046F-14	3	4.000	2.250	K	O				
DWX-055F-8	0.437	0.055	1	15	0.466	1.5	29.000	E	F
DWX-055F-8.5			1 1/8		0.600		22.500	E	F
DWX-055F-9			1 1/4		0.711		19.000	E	F
DWX-055F-9.5			1 3/8		0.844		16.000	E	F
DWX-055F-10			1 1/2		0.964		14.000	E	F
DWX-055F-11			1 3/4		1.227		11.000	F	H
DWX-055F-12			2		1.452		9.300	I	K
DWX-055F-12.5			2 1/4		1.688		8	I	K
DWX-055F-13			2 1/2		1.985		6.8	I	K
DWX-055F-13.5			2 3/4		2.250		6	J	N
DWX-055F-14	3	2.500	5.4	K	O				
DWX-034G-9	0.5	0.034	1 1/4	3.6	1.746	0.3	1.890	D	E
DWX-034G-9.5			1 3/8		2.324		1.420	D	E
DWX-034G-10			1 1/2		3.000		1.100	D	E
DWX-034G-11			1 3/4		4.161		0.793	E	F
DWX-034G-12			2		5.410		0.610	F	H
DWX-034G-12.5			2 1/4		6.653		0.496	F	H
DWX-037G-9	0.5	0.037	1 1/4	4.3	1.300	0.4	3.000	D	E
DWX-037G-9.5			1 3/8		1.773		2.200	D	E
DWX-037G-10			1 1/2		2.294		1.700	D	E
DWX-037G-11			1 3/4		3.250		1.200	E	F
DWX-037G-12			2		4.333		0.900	F	H
DWX-037G-12.5			2 1/4		5.091		0.766	G	H
DWX-041G-9	0.5	0.041	1 1/4	5.8	1.082	0.5	4.900	D	E
DWX-041G-9.5			1 3/8		2.409		2.200	D	E
DWX-041G-10			1 1/2		3.118		1.700	D	E

EXTENSION SPRINGS

Note: Wire Dia. up to .098" is Music Wire (MW); .105" and over is Oil Tempered Wire (OT). Above rates and loads are multiplied by .833 when using stainless. For prices from 1 to 100 see Price Index. Please inquire if you need a size not listed above.

STOCK EXTENSION SPRINGS

Music Wire or Stainless

Loops in Random Position

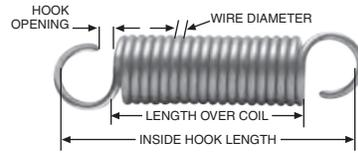

EXTENSION SPRINGS

DIAMOND SPRING STOCK NO.	OUTSIDE DIA.	WIRE DIA.	INSIDE HOOK LENGTH	SAFE MAX. LOAD	SAFE MAX. EXTENSION	~INITIAL TENSION	RATE - LB / IN. EXTENSION	PRICE CODE	
	IN.	IN.	IN.	LBS.	IN.	LBS.	LB. / IN.	MW/OT	S S
DWX-041G-11	0.5	0.041	1 3/4	5.8	4.417	0.5	1.200	E	F
DWX-041G-12			2		5.889		0.900	F	H
DWX-041G-12.5			2 1/4		6.919		0.766	G	H
DWX-045G-8	0.5	0.045	1	7.5	0.312	0.7	21.800	D	E
DWX-045G-9			1 1/4		0.883		7.700	D	E
DWX-045G-9.5			1 3/8		1.193		5.700	D	E
DWX-045G-10			1 1/2		1.447		4.700	D	E
DWX-045G-11			1 3/4		2.000		3.400	E	F
DWX-045G-12			2		2.615		2.600	E	F
DWX-045G-12.5			2 1/4		3.238		2.100	G	H
DWX-045G-13			2 1/2		3.778		1.800	G	H
DWX-045G-13.5			2 3/4		4.387		1.550	G	H
DWX-045G-14			3		4.964		1.370	G	H
DWX-049G-9	0.5	0.049	1 1/4	10	0.773	0.88	11.800	E	F
DWX-049G-10			1 1/2		1.256		7.260	E	F
DWX-049G-11			1 3/4		1.740		5.240	E	F
DWX-049G-12			2		2.280		4.000	E	F
DWX-049G-12.5			2 1/4		2.764		3.300	E	F
DWX-049G-13			2 1/2		3.257		2.800	E	F
DWX-049G-13.5			2 3/4		3.800		2.400	F	H
DWX-049G-14			3		4.262		2.140	G	H
DWX-049G-15			3 1/2		5.211		1.750	H	I
DWX-049G-16	4	6.204	1.470	I	K				
DWX-055G-9	0.5	0.055	1 1/4	13.2	0.577	1.3	20.640	E	F
DWX-055G-9.5			1 3/8		0.763		15.600	E	F
DWX-055G-10			1 1/2		0.915		13.000	E	F
DWX-055G-11			1 3/4		1.266		9.400	E	F
DWX-055G-12			2		1.608		7.400	E	F
DWX-055G-12.5			2 1/4		1.951		6.100	E	F
DWX-055G-13			2 1/2		2.288		5.200	F	H
DWX-055G-13.5			2 3/4		2.644		4.500	H	I
DWX-055G-14			3		3.051		3.900	I	K
DWX-055G-15			3 1/2		3.719		3.200	I	K
DWX-055G-16	4	4.407	2.700	J	N				
DWX-055G-17	4 1/2	5.174	2.300	K	O				
DWX-055G-18	5	5.749	2.070	L	Q				
DWX-063G-9	0.5	0.063	1 1/4	19	0.418	2	40.630	E	F
DWX-063G-9.5			1 3/8		0.541		31.400	E	F
DWX-063G-10			1 1/2		0.661		25.700	E	F
DWX-063G-11			1 3/4		0.899		18.900	E	F
DWX-063G-12			2		1.141		14.900	E	F
DWX-063G-12.5			2 1/4		1.382		12.300	E	F
DWX-063G-13			2 1/2		1.589		10.700	F	H
DWX-063G-13.5			2 3/4		1.868		9.100	H	I
DWX-063G-14			3		2.073		8.200	I	K
DWX-063G-15			3 1/2		2.537		6.700	I	K
DWX-063G-16	4	3.036	5.600	J	N				

Note: Wire Dia. up to .098" is Music Wire (MW); .105" and over is Oil Tempered Wire (OT). Above rates and loads are multiplied by .833 when using stainless. For prices from 1 to 100 see Price Index. Please inquire if you need a size not listed above.

STOCK EXTENSION SPRINGS

Music Wire or Stainless

Loops in Random Position

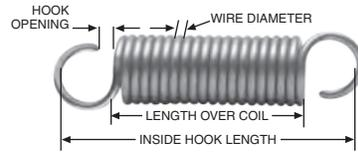

DIAMOND SPRING STOCK NO.	OUTSIDE DIA.	WIRE DIA.	INSIDE HOOK LENGTH	SAFE MAX. LOAD	SAFE MAX. EXTENSION	~INITIAL TENSION	RATE - LB / IN. EXTENSION	PRICE CODE	
	IN.	IN.	IN.	LBS.	IN.	LBS.	LB. / IN.	MW/OT	S S
DWX-063G-17	0.5	0.063	4 1/2	19	3.542	2	4.800	K	O
DWX-063G-18			5		3.953		4.300	L	Q
DWX-067G-9	0.5	0.067	1 1/4	24	0.371	3.5	55.300	F	H
DWX-067G-10			1 1/2		0.576		35.600	F	H
DWX-067G-11			1 3/4		0.782		26.200	F	H
DWX-067G-12			2		0.986		20.800	F	H
DWX-067G-12.5			2 1/4		1.192		17.200	F	H
DWX-067G-13			2 1/2		1.395		14.700	G	H
DWX-067G-13.5			2 3/4		1.602		12.800	I	K
DWX-067G-14			3		1.814		11.300	J	N
DWX-067G-15			3 1/2		2.228		9.200	J	N
DWX-067G-16			4		2.628		7.800	K	O
DWX-067G-17			4 1/2		3.060		6.700	L	Q
DWX-067G-18	5	3.475	5.900	M	T				
DWX-075G-9	0.5	0.075	1 1/4	35	0.307	5	97.620	G	H
DWX-075G-10			1 1/2		0.469		63.960	G	H
DWX-075G-11			1 3/4		0.631		47.560	G	H
DWX-075G-12			2		0.793		37.850	G	H
DWX-075G-12.5			2 1/4		0.954		31.440	G	H
DWX-075G-13			2 1/2		1.116		26.880	H	I
DWX-075G-13.5			2 3/4		1.278		23.480	J	N
DWX-075G-14			3		1.440		20.840	K	O
DWX-075G-15			3 1/2		1.763		17.020	K	O
DWX-075G-16			4		2.086		14.380	L	Q
DWX-075G-17	4 1/2	2.410	12.450	M	T				
DWX-075G-18	5	2.735	10.970	N	U				
DWX-055H-10	0.625	0.055	1 1/2	10.5	0.967	1	9.820	F	H
DWX-055H-11			1 3/4		1.550		6.130	F	H
DWX-055H-12			2		2.111		4.500	F	H
DWX-055H-12.5			2 1/4		2.714		3.500	F	H
DWX-055H-13			2 1/2		3.276		2.900	H	I
DWX-055H-13.5			2 3/4		3.800		2.500	H	I
DWX-055H-14			3		4.524		2.100	I	K
DWX-055H-15			3 1/2		5.588		1.700	J	N
DWX-055H-16	4	6.786	1.400	K	O				
DWX-063H-12	0.625	0.063	2	15	1.517	1.5	8.900	G	H
DWX-063H-12.5			2 1/4		2.015		6.700	G	H
DWX-063H-13			2 1/2		2.328		5.800	H	I
DWX-063H-13.5			2 3/4		2.755		4.900	H	I
DWX-063H-14			3		3.140		4.300	I	K
DWX-063H-15			3 1/2		3.971		3.4	J	N
DWX-063H-16			4		4.655		2.9	K	O
DWX-063H-17			4 1/2		5.625		2.4	L	Q
DWX-063H-18	5	6.338	2.13	M	T				
DWX-069H-12	0.625	0.069	2	19	1.206	2	14.100	G	H
DWX-069H-12.5			2 1/4		1.504		11.300	G	H
DWX-069H-13			2 1/2		1.809		9.400	H	I
DWX-069H-13.5			2 3/4		2.099		8.100	H	I

Note: Wire Dia. up to .098" is Music Wire (MW); .105" and over is Oil Tempered Wire (OT). Above rates and loads are multiplied by .833 when using stainless. For prices from 1 to 100 see Price Index. Please inquire if you need a size not listed above.

EXTENSION SPRINGS

STOCK EXTENSION SPRINGS

Music Wire or Stainless

Loops in Random Position

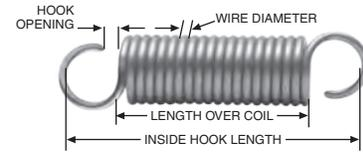

DIAMOND SPRING STOCK NO.	OUTSIDE DIA.	WIRE DIA.	INSIDE HOOK LENGTH	SAFE MAX. LOAD	SAFE MAX. EXTENSION	~INITIAL TENSION	RATE - LB / IN. EXTENSION	PRICE CODE	
	IN.	IN.	IN.	LBS.	IN.	LBS.	LB. / IN.	MW/OT	S S
DWX-069H-14	0.625	0.069	3	19	2.394	2	7.100	I	K
DWX-069H-15			3 1/2		3.036		5.600	J	N
DWX-069H-16			4		3.696		4.600	K	O
DWX-069H-17			4 1/2		4.250		4.000	L	Q
DWX-069H-18			5		4.899		3.470	M	T
DWX-049I-12	0.75	0.049	2	6.6	2.613	0.59	2.300	G	H
DWX-049I-12.5			2 1/4		4.007		1.500	H	I
DWX-049I-13			2 1/2		5.008		1.200	I	K
DWX-049I-13.5			2 3/4		6.678		0.900	J	N
DWX-049I-14			3		7.513		0.800	J	N
DWX-049I-14.5	3 1/4	8.586	0.700	K	O				
DWX-049I-15	3 1/2	10.017	0.600	L	Q				
DWX-055I-12	0.75	0.055	2	8.8	2.353	0.8	3.400	H	I
DWX-055I-12.5			2 1/4		3.200		2.500	I	K
DWX-055I-13			2 1/2		4.000		2.000	I	K
DWX-055I-13.5			2 3/4		5.000		1.600	J	N
DWX-055I-14			3		5.714		1.400	J	N
DWX-055I-15	3 1/2	8.000	1.000	L	Q				
DWX-063I-12	0.75	0.063	2	12.8	1.758	1.2	6.600	G	H
DWX-063I-12.5			2 1/4		2.367		4.900	H	I
DWX-063I-13			2 1/2		3.053		3.800	H	I
DWX-063I-13.5			2 3/4		3.625		3.200	I	K
DWX-063I-14			3		4.296		2.700	I	K
DWX-063I-15			3 1/2		5.524		2.100	K	O
DWX-063I-16			4		6.824		1.700	L	Q
DWX-063I-17			4 1/2		8.286		1.400	M	T
DWX-063I-18			5		9.667		1.200	O	W
DWX-063I-18.5	5 1/2	10.545	1.100	O	W				
DWX-069I-12	0.75	0.069	2	16.5	1.454	1.6	10.250	H	I
DWX-069I-12.5			2 1/4		1.935		7.700	H	I
DWX-069I-13			2 1/2		2.423		6.150	I	K
DWX-069I-13.5			2 3/4		2.904		5.130	I	K
DWX-069I-14			3		3.457		4.310	J	N
DWX-069I-15			3 1/2		4.421		3.370	L	Q
DWX-069I-16			4		5.458		2.730	M	T
DWX-069I-17			4 1/2		6.422		2.320	N	U
DWX-069I-18			5		7.450		2.000	O	W
DWX-069I-18.5	5 1/2	8.418	1.770	P	Z				
DWX-075I-12	0.75	0.075	2	20.7	1.154	2	16.200	H	I
DWX-075I-12.5			2 1/4		1.585		11.800	H	I
DWX-075I-13			2 1/2		2.011		9.300	I	K
DWX-075I-13.5			2 3/4		2.367		7.900	I	K
DWX-075I-14			3		2.791		6.700	J	N
DWX-075I-15			3 1/2		3.596		5.200	L	Q
DWX-075I-16			4		4.349		4.300	M	T
DWX-075I-17			4 1/2		5.194		3.600	N	U
DWX-075I-18			5		6.032		3.100	O	W

Note: Wire Dia. up to .098" is Music Wire (MW); .105" and over is Oil Tempered Wire (OT). Above rates and loads are multiplied by .833 when using stainless. For prices from 1 to 100 see Price Index. Please inquire if you need a size not listed above.

EXTENSION SPRINGS

STOCK EXTENSION SPRINGS

Music Wire or Stainless

Loops in Random Position

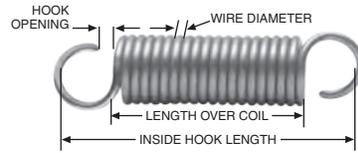

DIAMOND SPRING STOCK NO.	OUTSIDE DIA.	WIRE DIA.	INSIDE HOOK LENGTH	SAFE MAX. LOAD	SAFE MAX. EXTENSION	~INITIAL TENSION	RATE - LB / IN. EXTENSION	PRICE CODE	
	IN.	IN.	IN.	LBS.	IN.	LBS.	LB. / IN.	MW/OT	S S
DWX-075I-18.5	0.75	0.075	5 1/2	20.7	6.850	2	2.730	P	Z
DWX-075I-19			6		7.633		2.45	T	Z
DWX-085I-12	0.75	0.085	2	31.5	0.915	2.8	31.36	I	K
DWX-085I-12.5			2 1/4		1.238		23.18	I	K
DWX-085I-13			2 1/2		1.561		18.38	J	N
DWX-085I-13.5			2 3/4		1.938		14.81	J	N
DWX-085I-14			3		2.208		13	K	O
DWX-085I-15			3 1/2		2.870		10	M	T
DWX-085I-16			4		3.500		8.2	N	U
DWX-085I-17			4 1/2		4.147		6.92	O	W
DWX-085I-18	5	4.736	6.06	P	Z				
DWX-093I-12	0.75	0.093	2	40	0.802	3.5	45.500	J	N
DWX-093I-12.5			2 1/4		1.037		35.200	J	N
DWX-093I-13			2 1/2		1.322		27.600	K	O
DWX-093I-13.5			2 3/4		1.553		23.500	L	Q
DWX-093I-14			3		1.789		20.400	M	T
DWX-093I-15			3 1/2		2.310		15.800	N	U
DWX-093I-16			4		2.829		12.900	O	W
DWX-093I-17			4 1/2		3.349		10.900	P	Z
DWX-093I-18	5	3.802	9.600	Q	Z				
DWX-105I-12	0.75	0.105	2	56	0.596	6	83.900	K	O
DWX-105I-12.5			2 1/4		0.779		64.200	K	O
DWX-105I-13			2 1/2		0.962		52.000	L	Q
DWX-105I-13.5			2 3/4		1.144		43.700	M	T
DWX-105I-14			3		1.326		37.700	N	U
DWX-105I-15			3 1/2		1.695		29.500	O	W
DWX-105I-16			4		2.058		24.300	P	Z
DWX-105I-17			4 1/2		2.427		20.600	Q	Z
DWX-105I-18	5	2.793	17.900	R	AA				
DWX-112I-12	0.75	0.112	2	69	0.523	8	116.690	L	Q
DWX-112I-12.5			2 1/4		0.679		89.830	L	Q
DWX-112I-13			2 1/2		0.835		73.020	M	T
DWX-112I-13.5			2 3/4		0.992		61.510	N	U
DWX-112I-14			3		1.148		53.130	O	W
DWX-112I-15			3 1/2		1.461		41.760	P	Z
DWX-112I-16			4		1.773		34.400	Q	Z
DWX-112I-17			4 1/2		2.086		29.240	R	AA
DWX-112I-18	5	2.399	25.430	S	AB				
DWX-055J-12	0.875	0.055	2	7.8	2.219	0.7	3.200	M	T
DWX-055J-12.5			2 1/4		3.381		2.100	M	T
DWX-055J-13			2 1/2		4.438		1.600	M	T
DWX-055J-13.5			2 3/4		5.917		1.200	M	T
DWX-063J-12.5	0.875	0.063	2 1/4	11.3	2.641	1	3.900	N	U
DWX-063J-13			2 1/2		3.552		2.900	N	U
DWX-063J-13.5			2 3/4		4.478		2.300	N	U
DWX-063J-14			3		5.421		1.900	O	W
DWX-063J-15			3 1/2		7.357		1.400	O	W

EXTENSION SPRINGS

Note: Wire Dia. up to .098" is Music Wire (MW); .105" and over is Oil Tempered Wire (OT). Above rates and loads are multiplied by .833 when using stainless. For prices from 1 to 100 see Price Index. Please inquire if you need a size not listed above.

STOCK EXTENSION SPRINGS

Music Wire or Stainless

Loops in Random Position

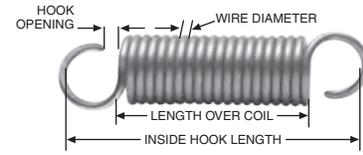

DIAMOND SPRING STOCK NO.	OUTSIDE DIA.	WIRE DIA.	INSIDE HOOK LENGTH	SAFE MAX. LOAD	SAFE MAX. EXTENSION	~INITIAL TENSION	RATE - LB / IN. EXTENSION	PRICE CODE	
	IN.	IN.	IN.	LBS.	IN.	LBS.	LB. / IN.	MW/OT	S S
DWX-075J-12.5	0.875	0.075	2 1/4	18.4	1.722	1.7	9.700	O	W
DWX-075J-13			2 1/2		2.227		7.500	O	W
DWX-075J-13.5			2 3/4		2.783		6.000	O	W
DWX-075J-14			3		3.340		5.000	O	W
DWX-075J-15			3 1/2		4.395		3.800	P	Z
DWX-075J-16			4		5.567		3.000	P	Z
DWX-075J-17			4 1/2		6.680		2.500	Q	Z
DWX-075J-17.5			4 3/4		7.261		2.300	Q	Z
DWX-075J-18			5		7.591		2.200	Q	Z
DWX-085J-12	0.875	0.085	2	25.9	0.870	2.4	27.000	P	Z
DWX-085J-12.5			2 1/4		1.224		19.200	P	Z
DWX-085J-13			2 1/2		1.679		14.000	P	Z
DWX-085J-13.5			2 3/4		2.117		11.100	P	Z
DWX-085J-14			3		2.474		9.500	P	Z
DWX-085J-15			3 1/2		3.219		7.300	R	AA
DWX-085J-16			4		4.052		5.800	R	AA
DWX-085J-17			4 1/2		4.796		4.900	R	AA
DWX-085J-17.5			4 3/4		5.222		4.500	R	AA
DWX-085J-18			5		5.732		4.1	R	AA
DWX-085J-18.5	5 1/2	6.528	3.6	R	AA				
DWX-085J-19	6	7.231	3.25	R	AA				
DWX-063K-13	1	0.063	2 1/2	9.7	3.385	0.9	2.600	P	Z
DWX-063K-13.5			2 3/4		4.632		1.900	P	Z
DWX-063K-14			3		5.867		1.500	P	Z
DWX-063K-14.5			3 1/4		7.333		1.200	P	Z
DWX-075K-13	1	0.075	2 1/2	15.7	2.270	1.4	6.300	Q	Z
DWX-075K-13.5			2 3/4		3.109		4.600	Q	Z
DWX-075K-14			3		3.972		3.600	Q	Z
DWX-075K-15			3 1/2		5.500		2.600	Q	Z
DWX-075K-16			4		7.150		2.000	R	AA
DWX-075K-17			4 1/2		8.412		1.700	S	AB
DWX-075K-18	5	10.214	1.400	S	AB				
DWX-085K-13.5	1	0.085	2 3/4	22.3	2.388	2	8.500	Q	Z
DWX-085K-14			3		2.985		6.800	Q	Z
DWX-085K-15			3 1/2		4.060		5.000	Q	Z
DWX-085K-16			4		5.205		3.900	R	AA
DWX-085K-17			4 1/2		6.344		3.200	T	AC
DWX-085K-18	5	7.519	2.700	T	AC				
DWX-095K-13.5	1	0.095	2 3/4	30	1.820	2.7	15.000	R	AA
DWX-095K-14			3		2.238		12.200	R	AA
DWX-095K-15			3 1/2		3.138		8.700	R	AA
DWX-095K-16			4		3.957		6.900	T	AC
DWX-095K-17			4 1/2		4.875		5.600	T	AC
DWX-095K-18			5		5.688		4.800	U	AD
DWX-095K-18.5			5 1/2		6.626		4.120	W	AE
DWX-095K-19			6		7.459		3.660	X	AF
DWX-095K-19.5			6 1/2		8.349		3.270	Y	AG
DWX-095K-20			7		9.223		2.960	Z	AI

Note: Wire Dia. up to .098" is Music Wire (MW); .105" and over is Oil Tempered Wire (OT). Above rates and loads are multiplied by .833 when using stainless. For prices from 1 to 100 see Price Index. Please inquire if you need a size not listed above.

EXTENSION SPRINGS

STOCK EXTENSION SPRINGS

Music Wire or Stainless

Loops in Random Position

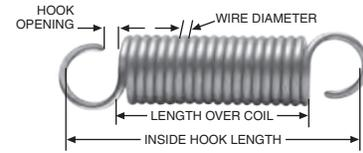

DIAMOND SPRING STOCK NO.	OUTSIDE DIA.	WIRE DIA.	INSIDE HOOK LENGTH	SAFE MAX. LOAD	SAFE MAX. EXTENSION	~INITIAL TENSION	RATE - LB / IN. EXTENSION	PRICE CODE	
	In.	In.	In.	Lbs.	In.	Lbs.	Lb. / In.	MW/OT	S S
DWX-105K-13.5	1	0.105	2 3/4	40	1.552	4	23.200	S	AB
DWX-105K-14			3		1.846		19.500	T	AC
DWX-105K-15			3 1/2		2.590		13.900	U	AD
DWX-105K-16			4		3.243		11.100	U	AD
DWX-105K-17			4 1/2		3.991		9.020	W	AE
DWX-105K-18			5		4.657		7.730	X	AG
DWX-105K-18.5			5 1/2		5.397		6.670	Y	AH
DWX-105K-19			6		6.133		5.870	Z	AI
DWX-105K-19.5			6 1/2		6.780		5.310	AA	AJ
DWX-105K-20			7		7.484		4.810	AB	AK
DWX-115K-13.5	1	0.115	2 3/4	50	1.178	5	38.200	T	AC
DWX-115K-14			3		1.490		30.200	T	AC
DWX-115K-15			3 1/2		1.982		22.700	U	AD
DWX-115K-16			4		2.542		17.700	W	AE
DWX-115K-17			4 1/2		3.103		14.500	X	AG
DWX-115K-18			5		3.600		12.500	Y	AH
DWX-115K-18.5			5 1/2		4.167		10.800	Z	AI
DWX-115K-19			6		4.737		9.500	AA	AJ
DWX-115K-19.5			6 1/2		5.233		8.600	AB	AK
DWX-115K-20			7		5.769		7.800	AC	AL
DWX-125K-13.5	1	0.125	2 3/4	70	1.082	7	58.210	U	AD
DWX-125K-14			3		1.323		47.620	U	AD
DWX-125K-15			3 1/2		1.804		34.920	V	AE
DWX-125K-16			4		2.285		27.570	X	AG
DWX-125K-17			4 1/2		2.766		22.780	Y	AH
DWX-125K-18			5		3.247		19.4	Z	AI
DWX-125K-18.5			5 1/2		3.728		16.9	AA	AJ
DWX-125K-19	6	4.208	14.97	AB	AK				
DWX-135K-13.5	1	0.135	2 3/4	85	0.881	9	86.230	V	AE
DWX-135K-14			3		1.072		70.880	V	AE
DWX-135K-15			3 1/2		1.454		52.280	W	AF
DWX-135K-16			4		1.835		41.410	Y	AG
DWX-135K-17			4 1/2		2.217		34.280	Z	AJ
DWX-135K-18			5		2.598		29.250	AA	AK
DWX-135K-18.5			5 1/2		2.980		25.500	AB	AL
DWX-135K-19	6	3.361	22.610	AC	AN				
DWX-085L-14	1.125	0.085	3	20.97	2.726	1.89	7.000	U	AD
DWX-085L-15			3 1/2		4.437		4.300	W	AF
DWX-085L-16			4		6.155		3.100	X	AG
DWX-085L-17			4 1/2		7.632		2.500	Y	AH
DWX-085L-18			5		9.540		2.000	Z	AJ
DWX-085L-18.5			5 1/2		11.224		1.700	AA	AK
DWX-085L-19			6		12.720		1.500	AC	AL
DWX-085L-19.5			6 1/2		14.677		1.300	AD	AM
DWX-085L-20			7		15.900		1.200	AE	AN
DWX-105L-14	1.125	0.105	3	37.8	1.755	3.4	19.600	W	AF
DWX-105L-15			3 1/2		2.752		12.500	W	AF
DWX-105L-16			4		3.739		9.200	Y	AG

EXTENSION SPRINGS

Note: Wire Dia. up to .098" is Music Wire (MW); .105" and over is Oil Tempered Wire (OT). Above rates and loads are multiplied by .833 when using stainless. For prices from 1 to 100 see Price Index. Please inquire if you need a size not listed above.

STOCK EXTENSION SPRINGS

Music Wire or Stainless

Loops in Random Position

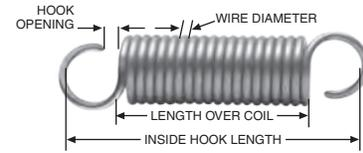

DIAMOND SPRING STOCK NO.	OUTSIDE DIA.	WIRE DIA.	INSIDE HOOK LENGTH	SAFE MAX. LOAD	SAFE MAX. EXTENSION	~INITIAL TENSION	RATE - LB / IN. EXTENSION	PRICE CODE					
	In.	In.	In.	Lbs.	In.	Lbs.	Lb. / In.	MW/OT	S S				
DWX-105L-17	1.125	0.105	4 1/2	37.8	4.712	3.4	7.300	Z	AH				
DWX-105L-18			5		5.733		6.000	AA	AK				
DWX-105L-18.5			5 1/2		6.745		5.100	AC	AL				
DWX-105L-19			6		7.644		4.500	AD	AM				
DWX-105L-19.5			6 1/2		8.821		3.900	AE	AO				
DWX-105L-20			7		9.829		3.500	AF	AP				
DWX-095M-14.5	1.25	0.095	3 1/4	26	3.249	2.35	7.280	V	AE				
DWX-095M-15			3 1/2		4.036		5.860	W	AF				
DWX-095M-16			4		5.462		4.330	Y	AG				
DWX-095M-17			4 1/2		7.167		3.300	Z	AH				
DWX-095M-18			5		8.727		2.710	AA	AI				
DWX-095M-18.5			5 1/2		10.283		2.300	AC	AK				
DWX-095M-19			6		11.884		1.990	AD	AL				
DWX-095M-19.5			6 1/2		13.438		1.760	AE	AM				
DWX-095M-20			7		15.064		1.570	AF	AN				
DWX-095M-20.5			7 1/2		16.538		1.430	AG	AO				
DWX-115M-14.5	1.25	0.115	3 1/4	45	2.256	4.25	18.060	AA	AI				
DWX-115M-15			3 1/2		2.772		14.700	AA	AI				
DWX-115M-16			4		3.801		10.720	AC	AK				
DWX-115M-17			4 1/2		4.834		8.430	AD	AL				
DWX-115M-18			5		5.863		6.950	AE	AM				
DWX-115M-18.5			5 1/2		6.895		5.910	AG	AO				
DWX-115M-19			6		7.928		5.140	AI	AQ				
DWX-115M-19.5			6 1/2		8.956		4.550	AJ	AS				
DWX-115M-20							7		9.988		4.080	AK	AT
DWX-115M-20.5			7 1/2		11.014		3.700	AL	AU				
DWX-135M-14.5	1.25	0.135	3 1/4	65	1.452	6.2	40.500	AD	AJ				
DWX-135M-15			3 1/2		1.709		34.400	AE	AK				
DWX-135M-16			4		2.306		25.500	AF	AL				
DWX-135M-17			4 1/2		2.985		19.700	AG	AM				
DWX-135M-18			5		3.585		16.400	AI	AO				
DWX-135M-18.5			5 1/2		4.324		13.600	AK	AO				
DWX-135M-19			6		4.941		11.9	AM	AP				
DWX-135M-19.5			6 1/2		5.547		10.6	AN	AR				
DWX-135M-20							7		6.189		9.5	AO	AT
DWX-135M-20.5			7 1/2		6.837		8.6	AP	AU				
DWX-125N-17	1.5	0.125	4 1/2	45	4.533	4.2	9	AI	AO				
DWX-125N-18			5		5.746		7.1	AJ	AP				
DWX-125N-18.5			5 1/2		6.951		5.87	AL	AR				
DWX-125N-19			6		8.160		5	AM	AS				
DWX-125N-19.5			6 1/2		9.379		4.35	AN	AT				
DWX-125N-20							7		10.570		3.86	AO	AU
DWX-125N-20.5							7 1/2		11.792		3.46	AP	AW
DWX-125N-21							8		12.994		3.14	AQ	AX

EXTENSION SPRINGS

Note: Wire Dia. up to .098" is Music Wire (MW); .105" and over is Oil Tempered Wire (OT). Above rates and loads are multiplied by .833 when using stainless. For prices from 1 to 100 see Price Index. Please inquire if you need a size not listed above.

**STOCK SNOW
PLOW SPRINGS**
Oil Tempered
Black Painted Finish



*Popular Plow Sizes
Extension Springs*

DIAMOND WIRE SPRING STOCK NO.	OUTSIDE DIAMETER	WIRE DIAMETER	INSIDE HOOK LENGTH	SAFE MAX. LOAD	SAFE MAX. EXTENSION	~INITIAL TENSION	RATE - LB / INCH EXTENSION	PRICE GROUP
	IN.	IN.	IN.	LBS.	IN.	LBS.	LB./IN.	
 DWS-PLOW-1B	2.375	0.383	14.000	600	17.500	190.000	135.000	AF
 DWS-PLOW-2SW	2.965	0.406	17.000	557	22.500	178.000	74.000	AP
 DWS-PLOW-3M	2.4	0.383	14.000	601	17.000	190.000	137.000	J
 DWS-PLOW-4D	3.1	0.375	9.000	451	13.000	119.000	88.000	J
 DWS-PLOW-5W	2.38	0.406	14	728	16.500	268.000	195.000	L

Compression and Torsion Springs

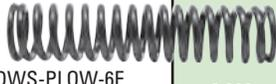
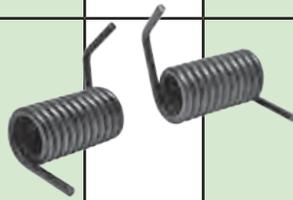
DIAMOND WIRE SPRING STOCK NO.	OUTSIDE DIAMETER	TO WORK IN HOLE DIA.	TO WORK OVER ROD DIA.	WIRE DIAMETER	APPROX. LOAD AT SOLID HT.	FREE LENGTH	SOLID HT.	TOTAL DEFLECTION	SPRING RATE	PRICE GROUP
	IN.	IN.	IN.	IN.	LB.	IN.	IN.	IN.	LB./IN.	
 DWS-PLOW-6F #87 SPRING	3.000	3.125	2.000	0.406	887.000	13.250	7.105	6.145	144.000	W
 DWS-PLOW-7D RIGHT OR LEFT TORSION	2.7		1.750	0.437		5.250				U

Please inquire if you need a size not listed above.

SNOW PLOW
SPRINGS

INDUSTRIAL STRENGTH DIE SPRINGS



Diamond Wire Spring provides you with a full line of rectangular wire die springs

- Spring tempered, rectangular-shaped chrome alloy wire
- Maximum fatigue life, achieved through stress relieving after coiling, preset and shot-peened
- Offered in a standard range of lengths, diameters and load specifications
- Patented color dipped end coding for easy identification of load range
- Designed heavy-duty to provide excellent quality, value, and service under severe conditions
- Can be custom made to match your specific requirements

Whatever your application, we pride ourselves on providing a spring that will meet your expectations for a long and dependable performance.

**STOCK DIE SPRINGS—
MEDIUM DUTY**
'Long Life' Alloy Die Springs
Rectangular Wire

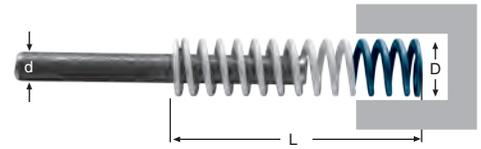

Color Code:
White With Blue Ends

Maximum Deflection*:
50% Of 'L'

Efficient Operating Range:
25% To 35% Of 'L'

D HOLE DIAMETER	d ROD DIAMETER	L FREE LENGTH	DIAMOND PART NUMBER	WIRE SIZE THICKNESS X WIDTH	SPRING RATE*	LOADS AT SOLID*	MAXIMUM DEFLECTION (APPROX.)
		IN.		IN.	LBS.	LBS.	IN.
3/8"	3/16"	1	M037-100	.039 X .070	56	31	0.500
		1 1/4	M037-125	.039 X .070	48	35	0.625
		1 1/2	M037-150	.039 X .070	38	34	0.750
		1 3/4	M037-175	.039 X .070	34	36	0.875
		2	M037-200	.039 X .070	28	35	1.000
		2 1/2	M037-250	.039 X .070	24	38	1.250
		3	M037-300	.039 X .070	18	35	1.500
		12	M037-1200	.039 X .070	6	48	6.000
1/2"	9/32"	1	M050-100	.052 X .093	100	58	0.500
		1 1/4	M050-125	.052 X .093	92	66	0.625
		1 1/2	M050-150	.052 X .093	76	68	0.750
		1 3/4	M050-175	.052 X .093	68	71	0.875
		2	M050-200	.052 X .093	64	79	1.000
		2 1/2	M050-250	.052 X .093	52	81	1.250
		3	M050-300	.052 X .093	40	76	1.500
		3 1/2	M050-350	.052 X .093	30	67	1.750
5/8"	11/32"	1	M062-100	.069 X .109	131	55	0.500
		1 1/4	M062-125	.069 X .109	128	79	0.625
		1 1/2	M062-150	.069 X .109	108	88	0.750
		1 3/4	M062-175	.069 X .109	96	93	0.875
		2	M062-200	.069 X .109	88	102	1.000
		2 1/2	M062-250	.069 X .109	60	87	1.250
		3	M062-300	.069 X .109	56	103	1.500
		3 1/2	M062-350	.069 X .109	48	104	1.750
3/4"	3/8"	1	M075-100	.075 X .165	312	170	0.500
		1 1/4	M075-125	.075 X .165	256	179	0.625
		1 1/2	M075-150	.075 X .165	200	171	0.750
		1 3/4	M075-175	.075 X .165	176	176	0.875
		2	M075-200	.075 X .165	144	167	1.000
		2 1/2	M075-250	.075 X .165	120	177	1.250
		3	M075-300	.075 X .165	96	171	1.500
		3 1/2	M075-350	.075 X .165	80	168	1.750
		4	M075-400	.075 X .165	72	173	2.000
		4 1/2	M075-450	.075 X .165	64	174	2.250
		5	M075-500	.075 X .165	56	169	2.500
		5 1/2	M075-550	.075 X .165	48	160	2.750
1"	1/2"	1	M100-100	.100 X .215	536	264	0.500
		1 1/4	M100-125	.100 X .215	436	272	0.625
		1 1/2	M100-150	.100 X .215	336	274	0.750
		1 3/4	M100-175	.100 X .215	288	272	0.875
		2	M100-200	.100 X .215	232	258	1.000
		2 1/2	M100-250	.100 X .215	200	282	1.250
		3	M100-300	.100 X .215	152	260	1.500

*Loads and Rate for reference only. Please inquire if you need a size not listed above.

**STOCK DIE SPRINGS—
MEDIUM DUTY**
'Long Life' Alloy Die Springs
Rectangular Wire

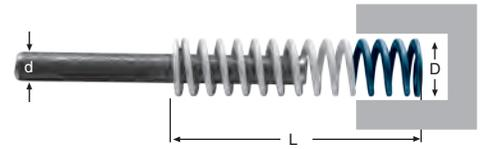

Color Code:
White With Blue Ends

Maximum Deflection*:
50% Of 'L'

Efficient Operating Range:
25% To 35% Of 'L'

D HOLE DIAMETER	d ROD DIAMETER	L FREE LENGTH	DIAMOND PART NUMBER	WIRE SIZE THICKNESS X WIDTH	SPRING RATE*	LOADS AT SOLID*	MAXIMUM DEFLECTION (APPROX.)		
		IN.						IN	LBS.
1"	1/2"	3 1/2	M100-350	.100 X .215	128	266	1.750		
		4	M100-400	.100 X .215	120	276	2.000		
		4 1/2	M100-450	.100 X .215	104	271	2.250		
		5	M100-500	.100 X .215	96	278	2.500		
		5 1/2	M100-550	.100 X .215	88	281	2.750		
		6	M100-600	.100 X .215	80	279	3.000		
		7	M100-700	.100 X .215	72	294	3.500		
		8	M100-800	.100 X .215	56	262	4.000		
		12	M100-1200	.100 X .215	40	282	6.000		
1 1/4"	5/8"	1 1/2	M125-150	.115 X .285	496	399	0.750		
		1 3/4	M125-175	.115 X .285	424	402	0.875		
		2	M125-200	.115 X .285	352	398	1.000		
		2 1/2	M125-250	.115 X .285	288	419	1.250		
		3	M125-300	.115 X .285	240	428	1.500		
		3 1/2	M125-350	.115 X .285	200	422	1.750		
		4	M125-400	.115 X .285	176	428	2.000		
		4 1/2	M125-450	.115 X .285	160	442	2.250		
		5	M125-500	.115 X .285	136	420	2.500		
		5 1/2	M125-550	.115 X .285	128	437	2.750		
		6	M125-600	.115 X .285	120	449	3.000		
		7	M125-700	.115 X .285	104	457	3.500		
		8	M125-800	.115 X .285	88	444	4.000		
		10	M125-1000	.115 X .285	72	457	5.000		
		12	M125-1200	.115 X .285	56	428	6.000		
1 1/2"	3/4"	2	M150-200	.135 X .345	448	500	1.000		
		2 1/2	M150-250	.135 X .345	368	532	1.250		
		3	M150-300	.135 X .345	336	597	1.500		
		3 1/2	M150-350	.135 X .345	264	547	1.750		
		4	M150-400	.135 X .345	216	526	2.000		
		4 1/2	M150-450	.135 X .345	208	575	2.250		
		5	M150-500	.135 X .345	200	619	2.500		
		5 1/2	M150-550	.135 X .345	168	576	2.750		
		6	M150-600	.135 X .345	144	541	3.000		
		7	M150-700	.135 X .345	136	601	3.500		
		8	M150-800	.135 X .345	128	650	4.000		
		10	M150-1000	.135 X .345	88	563	5.000		
				12	M150-1200	.135 X .345	80	606	6.000
		2"	1"	2 1/2	M200-250	.195 X .468	896	1179	1.250
3	M200-300			.195 X .468	768	1243	1.500		
3 1/2	M200-350			.195 X .468	648	1245	1.750		
4	M200-400			.195 X .468	552	1228	2.000		
4 1/2	M200-450			.195 X .468	472	1193	2.250		
5	M200-500			.195 X .468	416	1177	2.500		
5 1/2	M200-550			.195 X .468	392	1228	2.750		
6	M200-600			.195 X .468	352	1209	3.000		
7	M200-700			.195 X .468	312	1260	3.500		
8	M200-800			.195 X .468	256	1189	4.000		
10	M200-1000			.195 X .468	208	1218	5.000		
				12	M200-1200	.195 X .468	168	1187	6.000

*Loads and Rate for reference only. Please inquire if you need a size not listed above.

DIE SPRINGS

**STOCK DIE SPRINGS—
MEDIUM-HEAVY DUTY**
'Long Life' Alloy Die Springs
Rectangular Wire

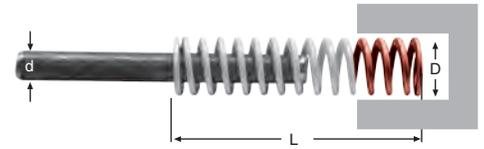

Color Code:
White With Red Ends

Maximum Deflection*:
37% Of 'L'

Efficient Operating Range:
20% To 25% Of 'L'

D HOLE DIAMETER	d ROD DIAMETER	L FREE LENGTH	DIAMOND PART NUMBER	WIRE SIZE THICKNESS X WIDTH	SPRING RATE*	LOADS AT SOLID*	MAXIMUM DEFLECTION (APPROX.)
		IN.					
3/8"	3/16"	1	MH037-100	.046 X .067	90	41	0.370
		1 1/4	MH037-125	.046 X .067	73	45	0.463
		1 1/2	MH037-150	.046 X .067	67	54	0.555
		1 3/4	MH037-175	.046 X .067	58	53	0.648
		2	MH037-200	.046 X .067	50	53	0.740
		2 1/2	MH037-250	.046 X .067	42	56	0.925
		3	MH037-300	.046 X .067	30	48	1.110
		12	MH037-1200	.046 X .067	9	64	4.440
1/2"	9/32"	1	MH050-100	.061 X .093	168	84	0.370
		1 1/4	MH050-125	.061 X .093	139	90	0.463
		1 1/2	MH050-150	.061 X .093	120	97	0.555
		1 3/4	MH050-175	.061 X .093	104	100	0.648
		2	MH050-200	.061 X .093	87	96	0.740
		2 1/2	MH050-250	.061 X .093	68	95	0.925
		3	MH050-300	.061 X .093	57	98	1.110
		3 1/2	MH050-350	.061 X .093	47	94	1.295
5/8"	11/32"	12	MH050-1200	.061 X .093	12	79	4.440
		1	MH062-100	.081 X .117	277	106	0.370
		1 1/4	MH062-125	.081 X .117	208	104	0.463
		1 1/2	MH062-150	.081 X .117	190	126	0.555
		1 3/4	MH062-175	.081 X .117	168	141	0.648
		2	MH062-200	.081 X .117	148	148	0.740
		2 1/2	MH062-250	.081 X .117	115	143	0.925
		3	MH062-300	.081 X .117	100	156	1.110
3/4"	3/8"	3 1/2	MH062-350	.081 X .117	85	155	1.295
		4	MH062-400	.081 X .117	76	166	1.480
		12	MH062-1200	.081 X .117	27	184	4.440
		1	MH075-100	.093 X .156	576	259	0.370
		1 1/4	MH075-125	.093 X .156	448	265	0.463
		1 1/2	MH075-150	.093 X .156	320	235	0.555
		1 3/4	MH075-175	.093 X .156	288	252	0.648
		2	MH075-200	.093 X .156	248	253	0.740
		2 1/2	MH075-250	.093 X .156	192	251	0.925
		3	MH075-300	.093 X .156	144	229	1.110
		3 1/2	MH075-350	.093 X .156	128	240	1.295
		1"	1/2"	4	MH075-400	.093 X .156	120
4 1/2	MH075-450			.093 X .156	112	274	1.665
5	MH075-500			.093 X .156	104	286	1.850
5 1/2	MH075-550			.093 X .156	96	289	2.035
6	MH075-600			.093 X .156	80	264	2.220
12	MH075-1200			.093 X .156	36	232	4.440
1	MH100-100			.115 X .218	720	297	0.370
1 1/4	MH100-125			.115 X .218	624	300	0.463
1 1/2	MH100-150	.115 X .218	496	350	0.555		
1 3/4	MH100-175	.115 X .218	440	364	0.648		
2	MH100-200	.115 X .218	368	368	0.740		
2 1/2	MH100-250	.115 X .218	288	373	0.925		
3	MH100-300	.115 X .218	232	369	1.110		

*Loads and Rate for reference only. Please inquire if you need a size not listed above.

**STOCK DIE SPRINGS—
MEDIUM-HEAVY DUTY**
'Long Life' Alloy Die Springs
Rectangular Wire

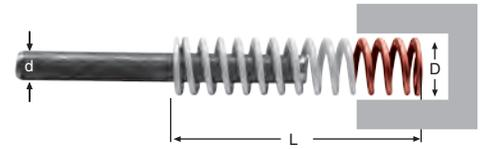

Color Code:
White With Red Ends

Maximum Deflection*:
37% Of 'L'

Efficient Operating Range:
20% To 25% Of 'L'

D HOLE DIAMETER	d ROD DIAMETER	L	DIAMOND PART NUMBER	WIRE SIZE THICKNESS X WIDTH	SPRING RATE*	LOADS AT SOLID*	MAXIMUM DEFLECTION (APPROX.)
		FREE LENGTH IN.					
1"	1/2"	3 1/2	MH100-350	.115 X .218	216	407	1.295
		4	MH100-400	.115 X .218	184	401	1.480
		4 1/2	MH100-450	.115 X .218	152	376	1.665
		5	MH100-500	.115 X .218	144	398	1.850
		5 1/2	MH100-550	.115 X .218	128	377	2.035
		6	MH100-600	.115 X .218	112	362	2.220
		7	MH100-700	.115 X .218	96	367	2.590
		8	MH100-800	.115 X .218	88	388	2.960
		12	MH100-1200	.115 X .218	56	379	4.440
1 1/4"	5/8"	1 1/2	MH125-150	.156 X .281	1144	752	0.555
		1 3/4	MH125-175	.156 X .281	1008	790	0.648
		2	MH125-200	.156 X .281	864	792	0.740
		2 1/2	MH125-250	.156 X .281	624	734	0.925
		3	MH125-300	.156 X .281	512	735	1.110
		3 1/2	MH125-350	.156 X .281	440	745	1.295
		4	MH125-400	.156 X .281	368	719	1.480
		4 1/2	MH125-450	.156 X .281	320	708	1.665
		5	MH125-500	.156 X .281	272	672	1.850
		5 1/2	MH125-550	.156 X .281	264	721	2.035
		6	MH125-600	.156 X .281	232	712	2.220
		7	MH125-700	.156 X .281	200	702	2.590
		8	MH125-800	.156 X .281	184	741	2.960
10	MH125-1000	.156 X .281	128	648	3.700		
12	MH125-1200	.156 X .281	112	683	4.440		
1 1/2"	3/4"	2	MH150-200	.187 X .312	1080	966	0.740
		2 1/2	MH150-250	.187 X .312	856	988	0.925
		3	MH150-300	.187 X .312	624	882	1.110
		3 1/2	MH150-350	.187 X .312	528	883	1.295
		4	MH150-400	.187 X .312	480	928	1.480
		4 1/2	MH150-450	.187 X .312	432	947	1.665
		5	MH150-500	.187 X .312	368	902	1.850
		5 1/2	MH150-550	.187 X .312	344	933	2.035
		6	MH150-600	.187 X .312	304	903	2.220
		7	MH150-700	.187 X .312	264	934	2.590
		8	MH150-800	.187 X .312	208	844	2.960
		10	MH150-1000	.187 X .312	176	907	3.700
12	MH150-1200	.187 X .312	144	883	4.440		
2"	1"	2 1/2	MH200-250	.225 X .437	1184	1326	0.925
		3	MH200-300	.225 X .437	960	1334	1.110
		3 1/2	MH200-350	.225 X .437	800	1328	1.295
		4	MH200-400	.225 X .437	664	1282	1.480
		4 1/2	MH200-450	.225 X .437	600	1320	1.665
		5	MH200-500	.225 X .437	560	1383	1.850
		5 1/2	MH200-550	.225 X .437	504	1381	2.035
		6	MH200-600	.225 X .437	472	1421	2.220
		7	MH200-700	.225 X .437	400	1420	2.590
		8	MH200-800	.225 X .437	352	1440	2.960
		10	MH200-1000	.225 X .437	240	1241	3.700
		12	MH200-1200	.225 X .437	224	1400	4.440

*Loads and Rate for reference only. Please inquire if you need a size not listed above.

DIE SPRINGS

**STOCK DIE SPRINGS—
HEAVY DUTY**
'Long Life' Alloy Die Springs
Rectangular Wire

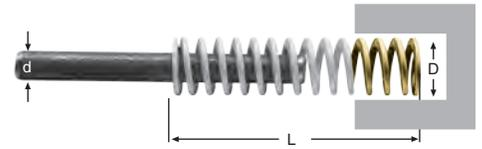

Color Code:
White With Gold Ends

Maximum Deflection*:
30% Of 'L'

Efficient Operating Range:
15% To 20% Of 'L'

D	d	L	DIAMOND PART NUMBER	WIRE SIZE THICKNESS X WIDTH	SPRING RATE*	LOADS AT SOLID*	MAXIMUM DEFLECTION (APPROX.)
HOLE DIAMETER	ROD DIAMETER	FREE LENGTH					
		IN.		IN.	LBS.	LBS.	IN.
3/8"	3/16"	1	H037-100	.054 X .072	124	44	0.300
		1 1/4	H037-125	.054 X .072	98	45	0.375
		1 1/2	H037-150	.054 X .072	96	55	0.450
		1 3/4	H037-175	.054 X .072	84	58	0.525
		2	H037-200	.054 X .072	72	57	0.600
		2 1/2	H037-250	.054 X .072	60	61	0.750
		3	H037-300	.054 X .072	42	51	0.900
		12	H037-1200	.054 X .072	12	70	3.600
1/2"	9/32"	1	H050-100	.070 X .093	236	107	0.300
		1 1/4	H050-125	.070 X .093	186	109	0.375
		1 1/2	H050-150	.070 X .093	164	121	0.450
		1 3/4	H050-175	.070 X .093	138	116	0.525
		2	H050-200	.070 X .093	110	110	0.600
		2 1/2	H050-250	.070 X .093	84	106	0.750
		3	H050-300	.070 X .093	74	113	0.900
		3 1/2	H050-350	.070 X .093	64	116	1.050
5/8"	11/32"	1	H062-100	.093 X .125	424	151	0.300
		1 1/4	H062-125	.093 X .125	296	140	0.375
		1 1/2	H062-150	.093 X .125	272	165	0.450
		1 3/4	H062-175	.093 X .125	240	175	0.525
		2	H062-200	.093 X .125	208	179	0.600
		2 1/2	H062-250	.093 X .125	170	190	0.750
		3	H062-300	.093 X .125	144	198	0.900
		3 1/2	H062-350	.093 X .125	122	199	1.050
3/4"	3/8"	1	H075-100	.125 X .165	1080	324	0.300
		1 1/4	H075-125	.125 X .165	880	358	0.375
		1 1/2	H075-150	.125 X .165	656	337	0.450
		1 3/4	H075-175	.125 X .165	600	361	0.525
		2	H075-200	.125 X .165	496	361	0.600
		2 1/2	H075-250	.125 X .165	376	354	0.750
		3	H075-300	.125 X .165	312	361	0.900
		3 1/2	H075-350	.125 X .165	264	361	1.050
		4	H075-400	.125 X .165	232	367	1.200
		4 1/2	H075-450	.125 X .165	200	359	1.350
		5	H075-500	.125 X .165	176	354	1.500
		5 1/2	H075-550	.125 X .165	160	356	1.650
6	H075-600	.125 X .165	144	351	1.800		
12	H075-1200	.125 X .165	72	382	3.600		
1"	1/2"	1	H100-100	.158 X .225	2080	614	0.300
		1 1/4	H100-125	.158 X .225	1712	539	0.375
		1 1/2	H100-150	.158 X .225	1184	598	0.450
		1 3/4	H100-175	.158 X .225	1040	655	0.525
		2	H100-200	.158 X .225	840	600	0.600
		2 1/2	H100-250	.158 X .225	680	628	0.750
		3	H100-300	.158 X .225	544	617	0.900

*Loads and Rate for reference only. Please inquire if you need a size not listed above.

**STOCK DIE SPRINGS—
HEAVY DUTY**
'Long Life' Alloy Die Springs
Rectangular Wire



Color Code: White With Gold Ends
Maximum Deflection*: 30% Of 'L'
Efficient Operating Range: 15% To 20% Of 'L'

D HOLE DIAMETER	d ROD DIAMETER	L FREE LENGTH IN.	DIAMOND PART NUMBER	WIRE SIZE THICKNESS X WIDTH IN.	SPRING RATE* LBS.	LOADS AT SOLID* LBS.	MAXIMUM DEFLECTION (APPROX.) IN.
1"	1/2"	3 1/2	H100-350	.158 X .225	456	612	1.050
		4	H100-400	.158 X .225	400	621	1.200
		4 1/2	H100-450	.158 X .225	352	621	1.350
		5	H100-500	.158 X .225	312	615	1.500
		5 1/2	H100-550	.158 X .225	288	628	1.650
		6	H100-600	.158 X .225	256	612	1.800
		7	H100-700	.158 X .225	224	630	2.100
		8	H100-800	.158 X .225	192	620	2.400
1 1/4"	5/8"	12	H100-1200	.158 X .225	120	589	3.600
		1 1/2	H125-150	.200 X .295	2120	954	0.450
		1 3/4	H125-175	.200 X .295	1816	1017	0.525
		2	H125-200	.200 X .295	1496	950	0.600
		2 1/2	H125-250	.200 X .295	1176	964	0.750
		3	H125-300	.200 X .295	952	957	0.900
		3 1/2	H125-350	.200 X .295	752	895	1.050
		4	H125-400	.200 X .295	664	913	1.200
		4 1/2	H125-450	.200 X .295	584	911	1.350
		5	H125-500	.200 X .295	496	866	1.500
		5 1/2	H125-550	.200 X .295	472	911	1.650
		6	H125-600	.200 X .295	424	897	1.800
		7	H125-700	.200 X .295	368	914	2.100
		8	H125-800	.200 X .295	328	936	2.400
1 1/2"	3/4"	10	H125-1000	.200 X .295	256	920	3.000
		12	H125-1200	.200 X .295	208	902	3.600
		2	H150-200	.225 X .350	1904	1346	0.600
		2 1/2	H150-250	.225 X .350	1488	1446	0.750
		3	H150-300	.225 X .350	1224	1443	0.900
		3 1/2	H150-350	.225 X .350	1064	1535	1.050
		4	H150-400	.225 X .350	912	1505	1.200
		4 1/2	H150-450	.225 X .350	784	1478	1.350
		5	H150-500	.225 X .350	712	1509	1.500
		5 1/2	H150-550	.225 X .350	640	1508	1.650
		6	H150-600	.225 X .350	584	1514	1.800
		7	H150-700	.225 X .350	496	1520	2.100
2"	1"	8	H150-800	.225 X .350	432	1527	2.400
		10	H150-1000	.225 X .350	344	1540	3.000
		12	H150-1200	.225 X .350	288	1561	3.600
		2 1/2	H200-250	.280 X .470	2200	1982	0.750
		3	H200-300	.280 X .470	1856	2129	0.900
		3 1/2	H200-350	.280 X .470	1600	2227	1.050
		4	H200-400	.280 X .470	1336	2188	1.200
		4 1/2	H200-450	.280 X .470	1176	2216	1.350
		5	H200-500	.280 X .470	1040	2214	1.500
		5 1/2	H200-550	.280 X .470	928	2204	1.650
		6	H200-600	.280 X .470	832	2181	1.800
		7	H200-700	.280 X .470	736	2290	2.100
8	H200-800	.280 X .470	640	2306	2.400		
10	H200-1000	.280 X .470	488	2238	3.000		
12	H200-1200	.280 X .470	400	2227	3.600		

*Loads and Rate for reference only. Please inquire if you need a size not listed above.

DIE SPRINGS

**STOCK DIE SPRINGS—
EXTRA-HEAVY DUTY**
'Long Life' Alloy Die Springs
Rectangular Wire

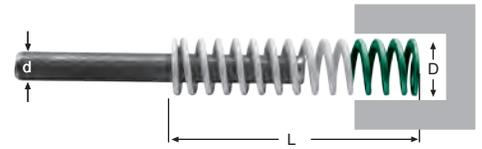

Color Code: White With Green Ends
Maximum Deflection*: 25% Of 'L'
Efficient Operating Range: 15% To 20% Of 'L'

D	d	L	DIAMOND PART NUMBER	WIRE SIZE THICKNESS X WIDTH	SPRING RATE*	LOADS AT SOLID*	MAXIMUM DEFLECTION (APPROX.)
HOLE DIAMETER	ROD DIAMETER	FREE LENGTH					
		IN.					
3/8"	3/16"	1	EH037-100	.059 X .080	220	61	0.250
		1 1/4	EH037-125	.059 X .080	170	60	0.313
		1 1/2	EH037-150	.059 X .080	145	64	0.375
		1 3/4	EH037-175	.059 X .080	115	55	0.438
		2	EH037-200	.059 X .080	100	60	0.500
		2 1/2	EH037-250	.059 X .080	80	62	0.625
		3	EH037-300	.059 X .080	65	60	0.750
		12	EH037-1200	.059 X .080	15	58	3.000
1/2"	9/32"	1	EH050-100	.084 X .097	320	94	0.250
		1 1/4	EH050-125	.084 X .097	240	86	0.313
		1 1/2	EH050-150	.084 X .097	200	94	0.375
		1 3/4	EH050-175	.084 X .097	170	90	0.438
		2	EH050-200	.084 X .097	140	95	0.500
		2 1/2	EH050-250	.084 X .097	115	92	0.625
		3	EH050-300	.084 X .097	90	88	0.750
		3 1/2	EH050-350	.084 X .097	80	94	0.875
5/8"	11/32"	1	EH062-100	.110 X .126	630	176	0.250
		1 1/4	EH062-125	.110 X .126	470	160	0.313
		1 1/2	EH062-150	.110 X .126	380	160	0.375
		1 3/4	EH062-175	.110 X .126	320	157	0.438
		2	EH062-200	.110 X .126	290	162	0.500
		2 1/2	EH062-250	.110 X .126	220	172	0.625
		3	EH062-300	.110 X .126	180	176	0.750
		3 1/2	EH062-350	.110 X .126	160	176	0.875
		4	EH062-400	.110 X .126	135	184	1.000
		12	EH062-1200	.110 X .126	45	185	3.000
3/4"	3/8"	1	EH075-100	.135 X .165	1400	301	0.250
		1 1/4	EH075-125	.135 X .165	1100	330	0.313
		1 1/2	EH075-150	.135 X .165	890	409	0.375
		1 3/4	EH075-175	.135 X .165	750	345	0.438
		2	EH075-200	.135 X .165	635	324	0.500
		2 1/2	EH075-250	.135 X .165	500	355	0.625
		3	EH075-300	.135 X .165	405	340	0.750
		3 1/2	EH075-350	.135 X .165	345	359	0.875
		4	EH075-400	.135 X .165	300	360	1.000
		4 1/2	EH075-450	.135 X .165	265	387	1.125
		5	EH075-500	.135 X .165	235	353	1.250
		5 1/2	EH075-550	.135 X .165	215	366	1.375
6	EH075-600	.135 X .165	195	361	1.500		
12	EH075-1200	.135 X .165	95	394	3.000		
1"	1/2"	1 1/2	EH100-150	.188 X .225	1848	632	0.375
		2	EH100-200	.188 X .225	1160	567	0.500
		2 1/2	EH100-250	.188 X .225	896	571	0.625
		3	EH100-300	.188 X .225	736	615	0.750
		3 1/2	EH100-350	.188 X .225	624	613	0.875
		4	EH100-400	.188 X .225	552	651	1.000
4 1/2	EH100-450	.188 X .225	488	672	1.125		

*Loads and Rate for reference only. Please inquire if you need a size not listed above.

**STOCK DIE SPRINGS—
EXTRA-HEAVY DUTY**
'Long Life' Alloy Die Springs
Rectangular Wire

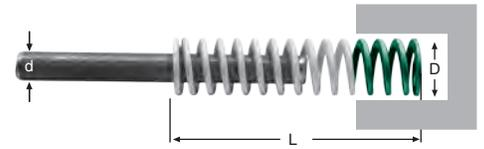

Color Code: White With Green Ends **Maximum Deflection*:** 25% Of 'L' **Efficient Operating Range:** 15% To 20% Of 'L'

D HOLE DIAMETER	d ROD DIAMETER	L FREE LENGTH	DIAMOND PART NUMBER	WIRE SIZE THICKNESS X WIDTH	SPRING RATE*	LOADS AT SOLID*	MAXIMUM DEFLECTION (APPROX.)
		IN.					
1"	1/2"	5	EH100-500	.188 X .225	432	659	1.250
		6	EH100-600	.188 X .225	360	674	1.500
		12	EH100-1200	.188 X .225	176	694	3.000
1 1/4"	5/8"	2	EH125-200	.225 X .295	1920	1002	0.500
		2 1/2	EH125-250	.225 X .295	1440	1045	0.625
		3	EH125-300	.225 X .295	1184	1102	0.750
		3 1/2	EH125-350	.225 X .295	1008	1144	0.875
		4	EH125-400	.225 X .295	840	1075	1.000
		4 1/2	EH125-450	.225 X .295	784	1164	1.125
		5	EH125-500	.225 X .295	680	1149	1.250
		5 1/2	EH125-600	.225 X .295	560	1142	1.375
		8	EH125-800	.225 X .295	416	1164	2.000
		10	EH125-1000	.225 X .295	336	1194	2.500
1 1/2"	3/4"	2	EH150-200	.300 X .350	3760	1861	0.500
		2 1/2	EH150-250	.300 X .350	2944	1840	0.625
		3	EH150-300	.300 X .350	2312	1896	0.750
		3 1/2	EH150-350	.300 X .350	1960	1911	0.875
		4	EH150-400	.300 X .350	1712	2001	1.000
		4 1/2	EH150-450	.300 X .350	1480	2017	1.125
		5	EH150-500	.300 X .350	1360	2118	1.250
		6	EH150-600	.300 X .350	1105	2149	1.500
		8	EH150-800	.300 X .350	808	2199	2.000
		10	EH150-1000	.300 X .350	672	2350	2.500
2"	1"	2 1/2	EH200-250	.365 X .460	3816	2851	0.625
		3	EH200-300	.365 X .460	3120	2702	0.750
		3 1/2	EH200-350	.365 X .460	2544	2310	0.875
		4	EH200-400	.365 X .460	2200	2691	1.000
		4 1/2	EH200-450	.365 X .460	1888	2622	1.125
		5	EH200-500	.365 X .460	1728	2428	1.250
		6	EH200-600	.365 X .460	1416	2280	1.500
		8	EH200-800	.365 X .460	1000	2234	2.000
		10	EH200-1000	.365 X .460	840	2448	2.500
		12	EH200-1200	.365 X .460	712	3184	3.000

*Loads and Rate for reference only. Please inquire if you need a size not listed above.

SPECIFICATION FORMS— COMPRESSION SPRINGS

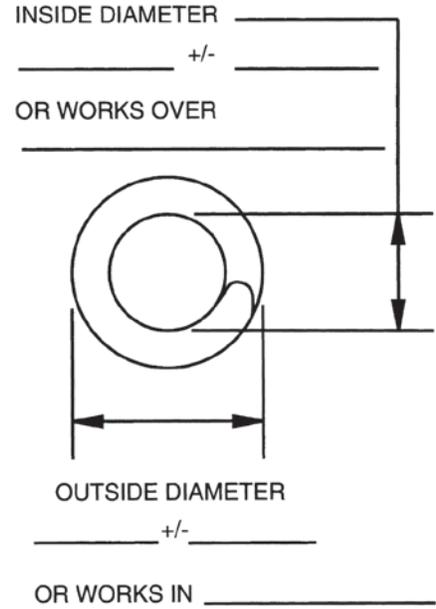
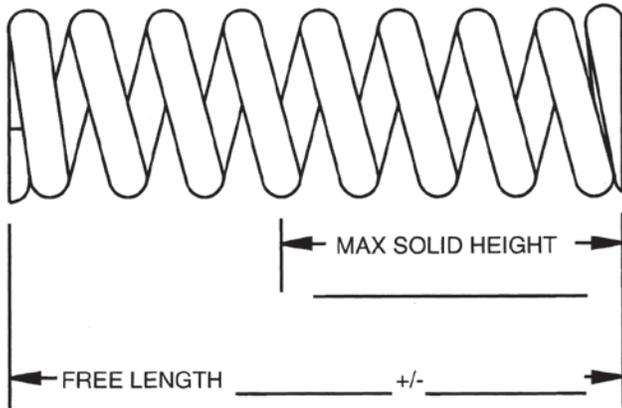
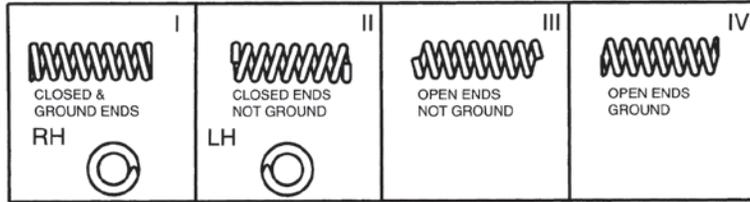

INDICATE UNITS OF MEASURE (IN & LB), (MM & KG)

1. MATERIAL _____
2. WIRE DIA. _____
3. DIRECTION OF WIND OPT, LH, RH
4. STYLE OF END I, II, III, IV
5. SQUARENESS _____
6. RATE _____ +/- _____ BETWEEN _____ & _____
7. LOAD 1 _____ +/- _____ @ _____
8. LOAD 2 _____ +/- _____ @ _____
9. No. OF ACTIVE COILS _____
10. TOTAL No. OF COILS _____
11. FINISH _____
12. FREQUENCY OF COMPRESSION _____ CYCLES/SEC.
AND WORKING RANGE _____ IN. TO _____ IN. OF LENGTH
13. OPERATING TEMP. _____ °F
14. OTHER: _____

COMPANY:		
ADDRESS:		
CITY:	ST:	ZIP:
CONTACT:		
PHONE:		
FAX:		
EMAIL:		
QUANTITIES TO BE QUOTED:		
END USE OR APPLICATION:		

SPECIFICATION FORMS— CONED COMPRESSION SPRINGS

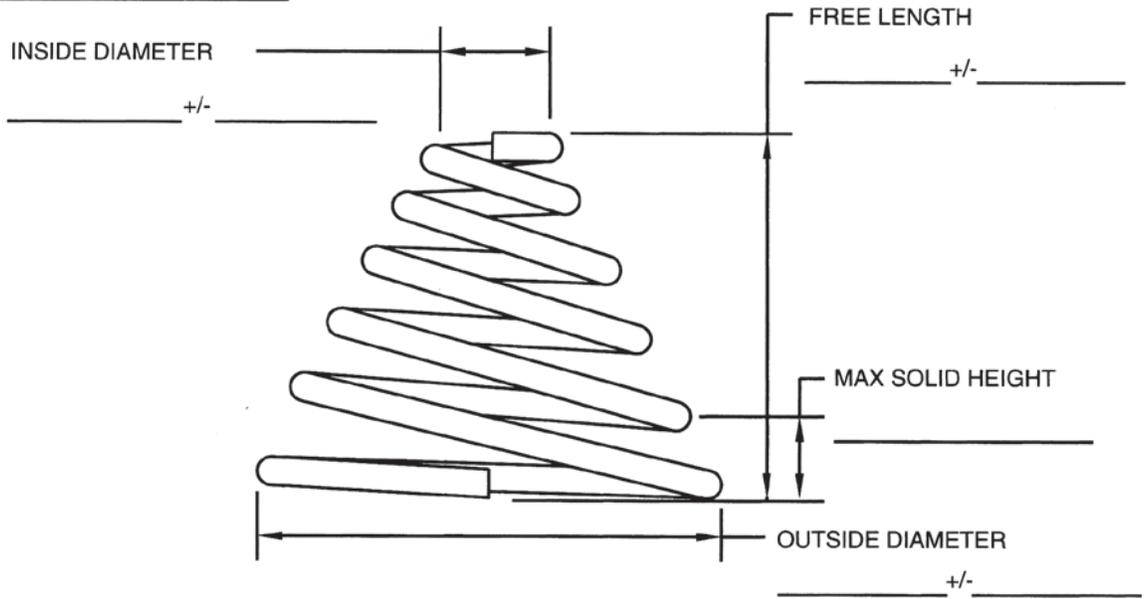
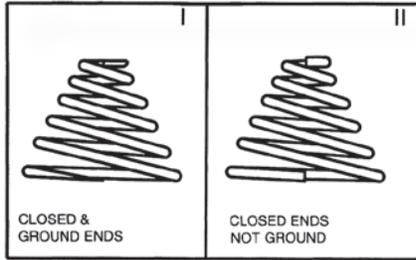

INDICATE UNITS OF MEASURE (IN & LB), (MM & KG)

1. MATERIAL _____
2. WIRE DIA. _____
3. DIRECTION OF WIND OPT, LH, RH
4. END STYLE I, II
5. RATE _____ +/- _____ BETWEEN _____ & _____
6. LOAD 1 _____ +/- _____ @ _____
7. LOAD 2 _____ +/- _____ @ _____
8. No. OF ACTIVE COILS _____
9. TOTAL No. OF COILS _____
10. FINISH _____
11. FREQUENCY OF COMPRESSION _____ CYCLES/SEC.
AND WORKING RANGE _____ IN. TO _____ IN. OF LENGTH
12. OPERATING TEMP. _____ °F
13. OTHER: _____

COMPANY:		
ADDRESS:		
CITY:	ST:	ZIP:
CONTACT:		
PHONE:		
FAX:		
EMAIL:		
QUANTITIES TO BE QUOTED:		
END USE OR APPLICATION:		

FORMS

SPECIFICATION FORMS— CONED EXTENSION SPRINGS

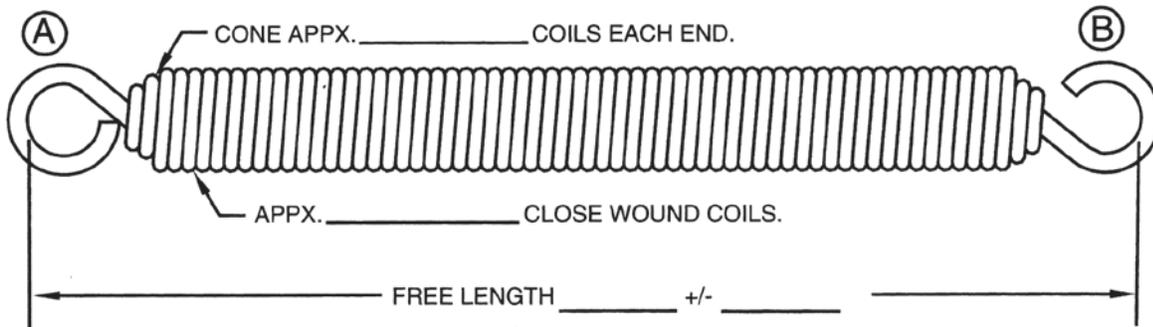
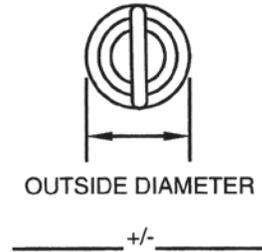
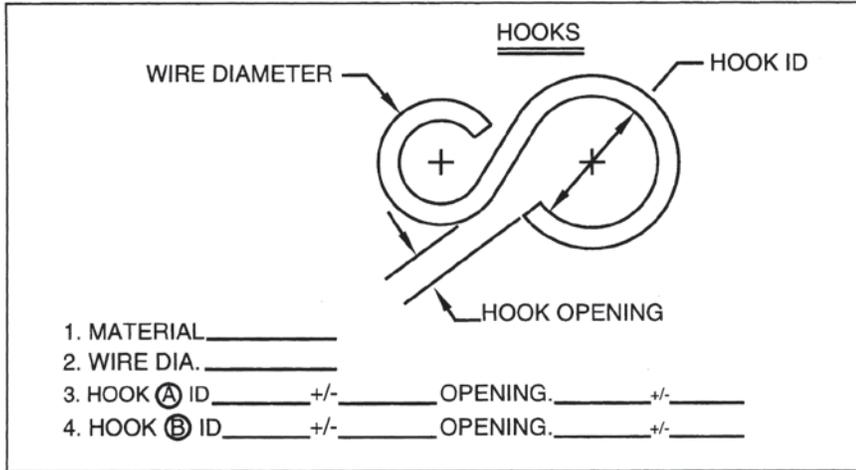

INDICATE UNITS OF MEASURE (IN & LB), (MM & KG)

1. MATERIAL _____
2. WIRE DIA. _____
3. DIRECTION OF WIND OPT, LH, RH
4. IT _____ +/- _____
5. RATE _____ +/- _____ BETWEEN _____ & _____
6. LOAD 1 _____ +/- _____ @ _____
7. LOAD 2 _____ +/- _____ @ _____
8. MAXIMUM EXTENDED LENGTH (INSIDE ENDS) WITHOUT SET

9. FINISH _____
10. FREQUENCY OF COMPRESSION _____ CYCLES/SEC.
AND WORKING RANGE _____ IN. TO _____ IN. OF LENGTH
11. OPERATING TEMP. _____ °F
12. OTHER: _____

COMPANY:		
ADDRESS:		
CITY:	ST:	ZIP:
CONTACT:		
PHONE:		
FAX:		
EMAIL:		
QUANTITIES TO BE QUOTED:		
END USE OR APPLICATION:		

SPECIFICATION FORMS— DRAWBAR SPRINGS



END STYLE

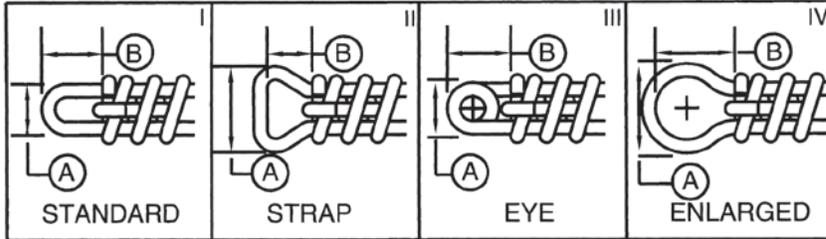

END ① I, II, III, IV
 DIM. A _____ +/- _____
 DIM. B _____ +/- _____

END ② I, II, III, IV
 DIM. A _____ +/- _____
 DIM. B _____ +/- _____

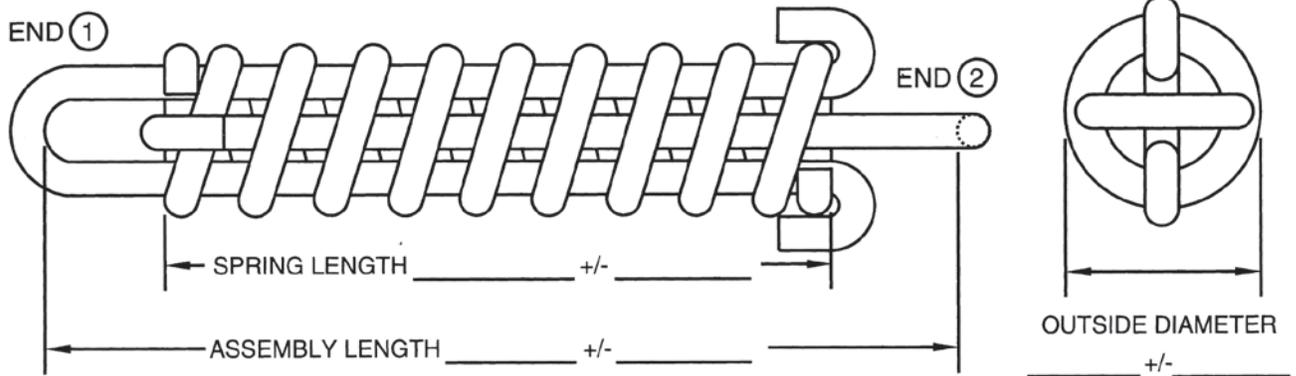

INDICATE UNITS OF MEASURE (IN & LB), (MM & KG)

1. (SPRING) MATERIAL _____ WIRE DIA. _____
2. (HOOK) MATERIAL _____ WIRE DIA. _____
4. RATE _____ +/- _____ BETWEEN _____ & _____
5. LOAD 1 _____ +/- _____ @ _____
6. LOAD 2 _____ +/- _____ @ _____
7. No. OF ACTIVE COILS _____
8. TOTAL No. OF COILS _____
9. FINISH _____
10. FREQUENCY OF COMPRESSION _____ CYCLES/SEC.
AND WORKING RANGE _____ IN. TO _____ IN. OF LENGTH
11. OPERATING TEMP. _____ °F
12. OTHER: _____

COMPANY:		
ADDRESS:		
CITY:	ST:	ZIP:
CONTACT:		
PHONE:		
FAX:		
EMAIL:		
QUANTITIES TO BE QUOTED:		
END USE OR APPLICATION:		

SPECIFICATION FORMS— EXTENSION SPRINGS



END STYLE	I MACHINE LOOPS	II CROSSOVER	III SIDE LOOPS	IV EXTENDED HOOKS
LOOP TYPE				
RECOMMENDED LOOP LENGTH				
MIN	1/2 I.D.	I.D.	I.D.	1.1 x I.D.
MAX	1.1 x I.D.	I.D.	I.D.	AS REQUIRED

LOOP/HOOK (A) LENGTH _____ +/- _____ OPENING _____ +/- _____
 LOOP/HOOK (B) LENGTH _____ +/- _____ OPENING _____ +/- _____

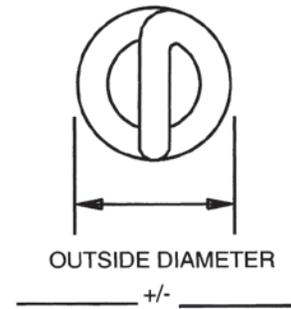
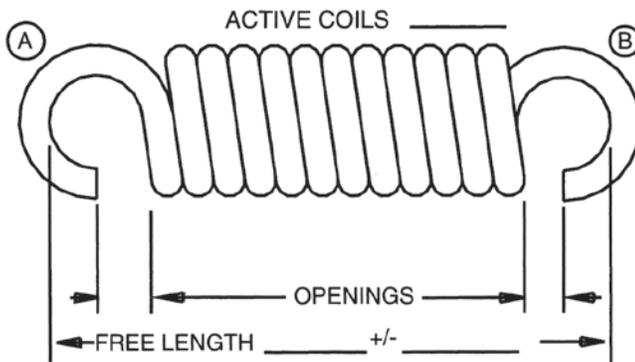

INDICATE UNITS OF MEASURE (IN & LB), (MM & KG)

- MATERIAL _____
- WIRE DIA. _____
- DIRECTION OF WIND OPT, LH, RH _____
- END STYLE (A) I, II, III, IV (B) I, II, III, IV (SEE ABOVE)
- IT _____ +/- _____
- RATE _____ +/- _____ BETWEEN _____ & _____
- LOAD 1 _____ +/- _____ @ _____
- LOAD 2 _____ +/- _____ @ _____
- MAXIMUM EXTENDED LENGTH (INSIDE ENDS) WITHOUT SET _____
- RELATIVE LOOP POSITION: _____ RANDOM OR _____ ALIGNED AT _____ DEGREE +/- _____ DEGREES
- FINISH _____
- FREQUENCY OF EXTENSION _____ CYCLES/SEC. AND WORKING RANGE _____ IN. TO _____ IN. OF LENGTH

- OPERATING TEMP. _____ °F
- OTHER: _____

COMPANY:
ADDRESS:
CITY: _____ ST: _____ ZIP: _____
CONTACT:
PHONE:
FAX:
EMAIL:
QUANTITIES TO BE QUOTED:
END USE OR APPLICATION:



TABLE 1

I Straight Offset Ends	II Short Hook Ends	III Double Torsion
IV Hinge Ends	V Straight Torsion Ends	VI Special Ends

TABLE 2

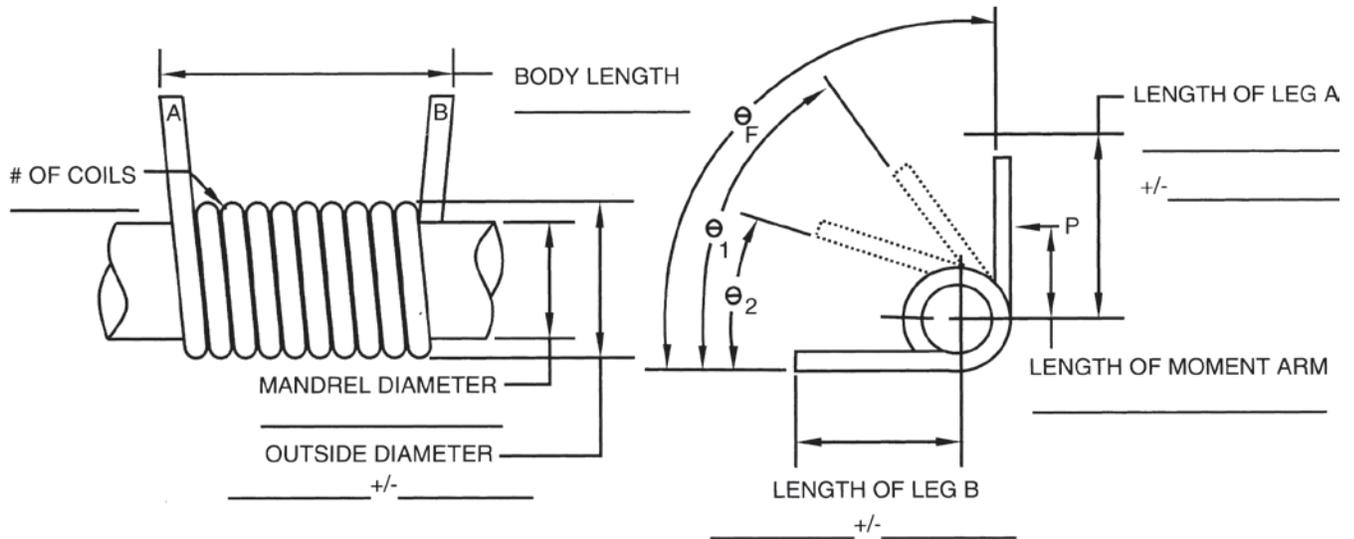
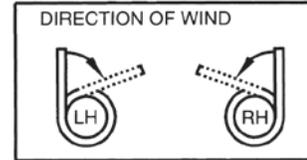

INDICATE UNITS OF MEASURE (IN & LB), (MM & KG)

- MATERIAL _____
- WIRE DIA. _____
- DIRECTION OF WIND LH, RH → SEE TABLE 2
- END STYLE (A) I, II, III, IV, V, VI SEE TABLE 1
- STYLE OF END (B) I, II, III, IV, V, VI
- RATE _____ +/- _____ PER TURN (360°)
- TORQUE 1 _____ +/- _____ AT θ_1 _____ °
- TORQUE 2 _____ +/- _____ AT θ_2 _____ °
- LENGTH OF SPACE AVAILABLE _____
- MAXIMUM WOUND POSITION _____ ° FROM FREE POSITION.
- θ_F _____ FREE ANGLE OR POSITON
- FINISH _____
- FREQUENCY OF ROTATION _____ CYCLES/SEC.
AND WORKING RANGE θ _____ ° TO θ _____ ° DEFLECTION.
- OPERATING TEMP. _____ °F

COMPANY:
ADDRESS:
CITY: ST: ZIP:
CONTACT:
PHONE:
FAX:
EMAIL:
QUANTITIES TO BE QUOTED:
END USE OR APPLICATION:

CONDITIONS OF SALE



- 1** The terms and conditions contained herein shall constitute the entire contract between Seller and Buyer with respect to Seller's products described herein. All proposals, negotiations or representations, if any, made prior and with reference hereto are merged herein.
- 2** The contract is expressly limited to the terms and conditions contained herein, and Buyer is hereby notified in advance of Seller's rejection of and objection to any proposed additional or different terms and conditions. Neither performance nor delivery by Seller nor receipt by Seller of any payment shall be deemed an acceptance of any additional or different terms and conditions. Performance and delivery by Seller shall be under, and pursuant to only the terms and conditions contained herein.
- 3** Seller reserves the right to adjust prices, to those prevailing at time of shipment due to any change in material and/or labor costs.
- 4** Prices are offered for acceptance within 30 days from quotation date.
- 5** Buyer agrees to hold harmless and indemnify Seller of and from all claims, suits, action, costs, counsel fees, expenses damages, judgments or decrees by reason of any person or persons being injured or property being damaged and destroyed because of any defect, latent or otherwise, in the article or articles sold.
- 6** Prices applying are subject to any sales, use or manufacturer's tax imposed by federal, state, municipal or other governmental authority upon the sale and/or use of manufacture of the materials mentioned herein, and the amount of such tax shall be in addition to the purchase price herein stated, and shall be paid by Buyer.
- 7** This quotation or order is subject to the approval of Seller's credit department.
- 8** Seller will not be responsible for delays in deliveries caused by strikes, differences with workmen, delays in transportation, delays at mill or other contingencies beyond Seller's control.
- 9** Prices quoted are on specific quantities mentioned, and are subject to price differentials on larger or smaller quantities.
- 10** We reserve the right to over or under ship by an amount not to exceed ten percent of the quantity ordered or released unless otherwise specified and agreed upon.
- 11** Charges made for tools and dies do not convey the right to remove them from our factory.
- 12** Seller's products are not guaranteed for any specific length of time or measure of service. Seller's products are warranted to be free from defects in workmanship and material according to the terms of this paragraph. All of Seller's products shall be subject to Seller's normal manufacturing tolerances and quality-control procedures. Buyer shall inspect all products when received, and Seller shall not be liable for any defects unless Seller is notified of such defects within thirty (30) days after Buyer's receipt. Buyer's sole and exclusive remedies for any breach of the express warranty set forth above are limited to, at Seller's option, with, either: (1) a refund of the purchase price for the defective product or, (2) replacement of the defective product upon its return to Seller.

CONDITIONS OF SALE



- 13** ALL IMPLIED WARRANTIES OF ANY KIND OR TYPE (INCLUDING WITHOUT LIMITATION OF MERCHANTABILITY OR OF FITNESS FOR A PARTICULAR PURPOSE) ARE HEREBY DISCLAIMED AND EXCLUDED, AND NO WARRANTY IS EXTENDED HEREBY OTHER THAN THE EXPRESS WARRANTY CONTAINED IN PARAGRAPH 12.
- 14** IN NO EVENT SHALL SELLER BE LIABLE TO BUYER OR OTHERS FOR INCIDENTAL OR CONSEQUENTIAL DAMAGES OR FOR LOSS OF PROFITS, WHETHER RESULTING FROM THE BREACH OF ANY WARRANTY, BREACH OF CONTRACT, NEGLIGENCE, TORT, STRICT TORT LIABILITY OR OTHERWISE.
- 15** To the extent that Buyer resells the products purchased from Seller and the contract for such resale does not include the provisions of Paragraphs 12, 13 and 14 set forth above, Buyer agrees to: (i) assume all liability for the breach of any other warranty, for any consequential or incidental damages, for any loss of profits or for any remedies other than refund or replacement with respect to such products and, (ii) indemnify and hold Seller harmless from and against any and all claims for breach of any other warranty or any implied warranties, for consequential or incidental damages, for loss of profits or for remedies other than refund or replacement with respect to such products.
- 16** Seller cannot be held liable for work done on material in Buyer's plant if this work was done without Seller's permission in writing.
- 17** Seller reserves the right to accept or reject cancellations on individual orders, kanban orders or partial shipments depending upon work in process or completed in stock, or raw materials ordered or in stock.
- 18** Seller's liability does not include the engineering of the springs or the end use for which they are purchased. Engineering recommendations constitute merely our opinion and best judgment, and are not a basis for liability.
- 19** We believe that our products are exempt from the Hazard Communication Standard under the definition given for "article" in the Final Rule.
- 20** The springs furnished on this order are manufactured to the standards published by the Spring Manufacturers Institute, Inc. unless otherwise specified.



Active Coils (na)

Those coils which are free to deflect under load. For compression springs with squared ends, the total number of coils minus two is a good approximation of the number of active coils. For extension springs, the number of active coils is approximately equal to the number of coils in its body. For extension springs with threaded inserts or swivel hooks, the number of active coils is less than the total coils in the body. Hooks and loops add to the number of active coils.

Angular Relationship of Ends

The relative position of the plane of the hooks or loops of extension springs to each other.

Baking

Heating of electroplated springs to relieve hydrogen embrittlement.

Buckling

Bowing or lateral deflection of compression springs when compressed, related to the slenderness ratio (L/D).

Closed Ends

Ends of compression springs where pitch of the end coils is reduced so that the end coils touch.

Closed and Ground Ends

As with closed ends, except that the end is ground to provide a flat plane.

Closed Length

See Solid Height.

Close-Wound

Coiled with adjacent coils touching.

Coils Per Inch

See Pitch.

Deflection (F)

Motion of spring ends or arms under the application or removal of an external load (P).

Elastic Limit

Maximum stress to which a material may be subjected without permanent set.

Endurance Limit

Maximum stress to which any given material will operate indefinitely without failure for a given minimum stress.

Free Angle

Angle between the arms of a torsion spring when the spring is not loaded.

Free Length (L)

The overall length of a spring in the unloaded position.

Frequency (natural)

The lowest inherent rate of free vibration of a spring itself (usually in cycles per second) with ends restrained.

Gradient

See Rate (R).

Heat Setting

Fixturing a spring at elevated temperature to minimize loss of load at operating temperature.

Helix

The spiral form (open or closed) of compression, extension, and torsion springs.

Hooke's Law

Load is proportional to displacement.

Hooks

Open loops or ends of extension springs.

Hot Pressing

See Heat Setting.

Hydrogen Embrittlement

Hydrogen absorbed in electroplating or pickling of carbon steels, tending to make the spring material brittle and susceptible to cracking and failure, particularly under sustained loads.

Hysteresis

The mechanical energy loss that always occurs under cyclic loading and unloading of a spring, proportional to the area between the loading and unloading load-deflection curves within the elastic range of a spring.

Initial Tension (Pi)

The force that tends to keep the coils of an extension spring closed and which must be overcome before the coils start to open.

Load (P)

The force applied to a spring that causes a deflection (F).

Loops

Coil-like wire shapes at the ends of extension springs that provide for attachment and force application.

Mean Coil Diameter (D)

Outside spring diameter (O.D.) minus one wire diameter (d).



Modulus in Shear or Torsion (G)

Coefficient of stiffness for extension and compression springs.

Modulus in Tension or Bending (E)

Coefficient of stiffness used for torsion and flat springs (Young's Modulus).

Moment (M)

See Torque.

Open Ends, Not Ground

End of a compression spring with a constant pitch for each coil.

Open Ends Ground

"Open ends, not ground" followed by an end grinding operation.

Passivating

Acid treatment of stainless steel to remove contaminants and improve corrosion resistance.

Permanent Set

A material that is deflected so far that its elastic properties have been exceeded and it does not return to its original condition upon release of load is said to have taken a "permanent set."

Pitch (p)

The distance from center to center of the wire in adjacent active coils. Recommended practice is to specify the number of active coils rather than pitch.

Preset

See Remove Set.

Rate (R)

Change in load per unit deflection, generally given in pounds per inch (N/mm).

Remove Set

The process of closing to solid height a compression spring which has been coiled longer than the desired finished length, so as to increase the apparent elastic limit.

Residual Stress

Stresses induced by set removal, shot peening, cold working, forming or other means. These stresses may or may not be beneficial, depending on the application.

Set

Permanent distortion which occurs when a spring is stressed beyond the elastic limit of the material.

Shot Peening

A cold-working process in which the material surface is peened to induce compressive stresses and thereby improve fatigue life.

Slenderness Ratio

Ratio of spring length (L) to mean coil diameter (D).

Solid Height (H)

Length of compression spring when under sufficient load to bring all coils into contact with adjacent coils.

Spring Index

Ratio of mean coil diameter (D) to wire diameter (d).

Squared and Ground Ends

See Closed and Ground Ends.

Squared Ends

See Closed Ends.

Squareness of Ends

Angular deviation between the axis of a compression spring and a normal to the plane of the ends.

Squareness Under Load

As in Squareness of Ends, except with the spring under load.

Stress Range

The difference in operating stresses at minimum and maximum loads.

Stress Relieve

To subject springs to low-temperature heat treatment so as to relieve residual stresses.

Torque (M)

A twisting action in torsion springs which tends to produce rotation, equal to the load multiplied by the distance (or moment arm) from the load to the axis of the spring body. Usually expressed in oz * in., lb. * in., lb. * ft., or in N * mm.

Total Number of Coils (Nt)

Number of active coils (na) plus the coils forming the ends.

Wahl Factor

A factor to correct stress in helical springs based on the index of the spring.

Glossary reprinted with permission from the Spring Manufacturers Institute (SMI) Handbook of Spring Design.



Alphonse J. Fazio



Jane G. Fazio

OUR HISTORY

1939 – Diamond Wire Spring Company, Pittsburgh, PA, is founded.

1941 – Company is incorporated.

1947 – Alphonse J. Fazio, a metallurgist, becomes sole owner and president.

1956 – Company moves to new larger location.

1959 – Mr. Fazio dies at the age of 49. His wife, Jane Fazio, continues the precision spring business founded by her husband in addition to caring for her seven children, ages 11 months through 14 years.

1969 – Mrs. Fazio oldest son enters the business. Other family members continue to join the company.

1971 – Diamond opens a plant in SC.

1982 – Diamond opens a plant in Tyler, TX.

1985 – Catalog Division is established in Pittsburgh to sell stock springs throughout the world.

1993 – Mrs. Fazio remains active as chairperson until her death.

2000 – Third generation of family enters the business.

Today, Diamond continues as a designer and manufacturer of industrial precision springs, family-owned and managed by members of the second and third generation. In the past as well as today, its success and accomplishments are realized through the company's dedicated and loyal employees in both production and management.



Bloomfield, PA initial location in 1939



Millvale, PA location, 1945 to 1956



Late 1940's production

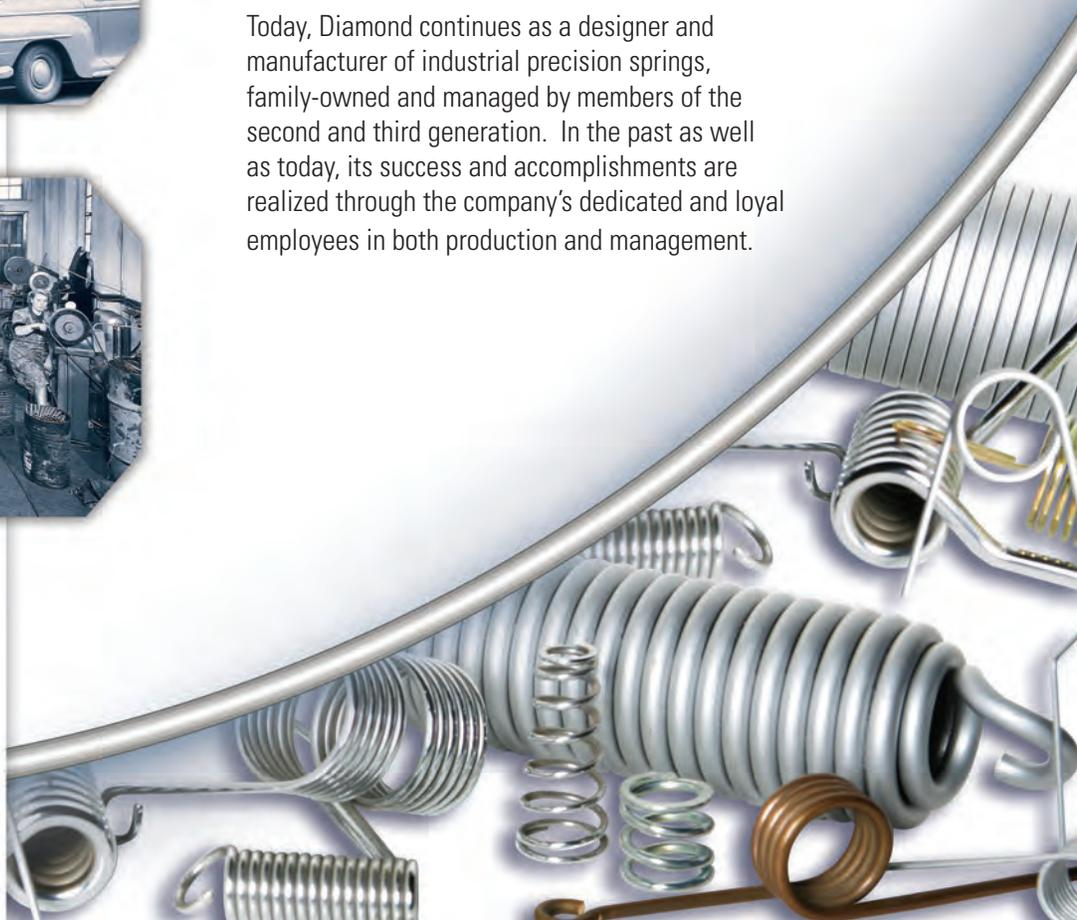

Capacity and Service for Custom Springs

- .003 through .750" wire diameters
- Special wire forms
- Design engineering
- Materials: carbon, alloy, stainless, phosphor bronze, inconel
- Quality assurance to meet government specs
- Quantities from one to millions
- Prompt service



1-800-424-0500

Fax: 412-492-0106

catalog@stocksprings.com

www.diamondwire.com



U.S. Corporate and Manufacturing Facilities

Corporate Headquarters/ Catalog Division

1479 Glenn Ave.
Glenshaw, PA 15116

1-800-424-0500

(412) 492-8280

FAX: (412) 492-0106



Northeast Plant

1901 Babcock Blvd.
Pittsburgh, PA 15209

1-800-816-5613

(412) 821-2703

FAX: (412) 821-2743



Southeast Plant

150 Landmark Ct.
Taylors, SC 29687

1-800-933-7774

(864) 292-2050

FAX: (864) 268-6705



Southwest Plant

4501 Candy Ln.
Tyler, TX 75701

1-800-238-3510

(903) 581-2358

FAX: (903) 581-6529

